

POLYMER SEALS

PRODUCT CATALOG



Hydraulic and
Pneumatic
Seals



Rotary
Seals



Spring
Energized
Seals

High Performance Polymer Sealing Solutions

Improve Equipment Reliability and Productivity, Reduce Maintenance and Operating Costs, Optimize Equipment Efficiency

In most heavy industries the need for consistent, high performance sealing solutions for fluid power reciprocating equipment, rotary and specialty equipment—specifically in demanding operating conditions and harsh environments—is mostly undervalued until it is too late, resulting in expensive equipment shutdown, repair and replacement, environmental and safety issues, and unbudgeted extra labor costs. Under-performing sealing solutions can even reduce the energy and resource efficiency, significantly impacting plant profitability.

The Chesterton® engineered polymer solutions life cycle approach is a contemporary way of support to achieve customer's asset/equipment life cycle management and plant-wellness goals.

Chesterton offers a broad range of innovative products and comprehensive programs focused on fluid power and rotary and specialty equipment reliability improvement. From high performance hydraulic and pneumatic seal systems that improve efficiency and reduce leakage, to rotary seals protecting expensive bearings and gearboxes, and to special spring-energized seals for ultra high-pressure and high-temperature applications in most challenging specialty equipment, Chesterton offers a full range of solutions to:

- Reduce Premature Failure
- Improve Reliability
- Reduce Repair, Maintenance, and Operating Costs
- Extend Equipment Life
- Optimize Performance



TABLE OF CONTENTS

How to Use This Catalog.....	4-5
Catalog Legend.....	5
Chesterton Polymer Seals Programs.....	6-7
Polymer Seals Product Selection Guide.....	8-9
Sealing Technology	10-11

HYDRAULIC AND PNEUMATIC SEALS

Wiper Seals

W21K.....	12
CW21K.....	13
WCCS	14

Rod Seals

R6K.....	15
R22K.....	16
R22KN.....	17
R22KE.....	18
R23K.....	19

Stacked Sets

R11K.....	20
R600	22
R8K.....	24
R27K.....	26
R28K.....	28

Compression Seals

R20K	29
RCCS	30

Piston Seals

P22K.....	32
P22KN	34
P22KE.....	36
P7K.....	37
P23K	38

Stacked Sets

P28K	39
P8K.....	40
P27K.....	42
P11K.....	44

Compression Seals

P20K	46
PCCS.....	48

Face and Static Seals

20KD.....	50
-----------	----

Ancillary Devices

9K	52
18K and 19K	54
WR	56
16K and 17K	58

ROTARY SEALS

Bearing and Gearbox Protection

R22KN5	60
33K	61
30K.....	62
50K.....	64
51K.....	66
52K.....	68
53K.....	70

Kaplan Turbine Runner Blade

Trunnion Split Seal.....	72
--------------------------	----

PLS	74
-----------	----

Stuffing Box Solutions

30KC	75
14K.....	76
14KL.....	77

SPRING ENERGIZED SEALS

100 Series.....	78
200 Series.....	80
300 Series.....	82
500 Series.....	84
600 Series.....	85

ENGINEERING GUIDE

Engineering Technical Guide.....	86
Engineering Introduction	88
Profile Guide.....	94
Recommended Seal Sizes and Standard Housing Dimensions.....	107
Standard Fits and Tolerances Data Chart.....	109
Application of ISO Standards Fits and Tolerances.....	110
Miscellaneous Hardware Guidelines—Reciprocating	112
Miscellaneous Hardware Guidelines—Rotary and Reciprocating.....	114
Miscellaneous Hardware Guidelines—Replaceable Wear Rings.....	115
Allowable Diametrical Clearance.....	118
Dynamic Sealing Surface Hardness.....	121
Surface Roughness	123
Operating Temperature Range.....	125
Hydraulic Fluids and Chemical Compatibility	126
Seal Materials.....	128
Storage and Shelf Life of Seal Components.....	135
ISO Reference List.....	136
Troubleshooting Guide.....	137
Engineering Action Request Form.....	143
EPS Industrial Cylinder Survey for Reciprocating Applications.....	145
Product Index.....	147

Important Note: This Catalog provides general guidelines and general information about product operating conditions and product options for experienced users to consider. Operating conditions not referred to in this Catalog may affect product selection and/or product performance. This Catalog should not be considered advice, a guarantee of product performance, or a replacement for addressing product application questions with a qualified professional. A.W. Chesterton Company and its affiliates assume no responsibility for any action or inaction you take based on or made in reliance on the information contained in this document.

How to Use This Catalog

USAGE

The catalog can be used to locate product using two different methods:

- By means of the **Table of Contents**
- By means of the **Product Selection Guide**

TABLE OF CONTENTS

Search the table of contents based on product type to quickly identify products offered.

- **Section I** – Hydraulic and Pneumatic Seals
Includes wiper seals, rod seals, piston seals and ancillary devices.
- **Section II** – Rotary Seals
Includes lip seals and labyrinth seals for bearing protection, and restriction bushings, lantern rings, and cartridge seals for stuffing boxes.
- **Section III** – Spring Energized Seals
Includes cantilever, elliptical coil, helical wound spring designs, and stacked V-Rings.
- **Section IV** – Engineering Guidelines
Includes profiles and descriptions, materials references, hardware design guidelines, ISO standard fits and tolerances, and troubleshooting guide.



POLYMER SEALS PRODUCT SELECTION GUIDE

Use the Polymer Seals Product Selection Guide if you need help identifying the appropriate product for your application. The product matrix was developed using motion and application speed as the foundation.

To use the guide:

- Confirm application speed
- Identify product offerings
- Locate page to review details



PRODUCT SECTION

Reference the product section, where all products are listed by type. Each product data sheet contains the following information.

- A** Product name and type
- B** Product description
- C** Technical data
- D** Equipment drawing
- E** Family of profiles
- F** Features and benefits

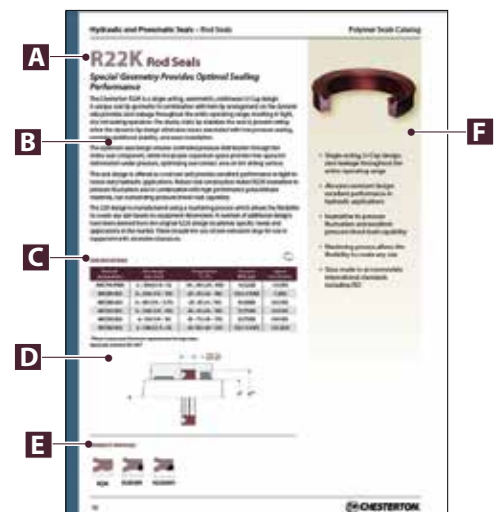

PLACING AN ORDER

To place an order, the required information is needed:

- Product profile
- Product material
- Equipment dimensions

For example:

To place an order for a hydraulic rod seal with a 50 mm rod diameter, a bore diameter of 70 mm and a seal groove height of 15 mm, the following information is required.

To place an order: Rod Seal

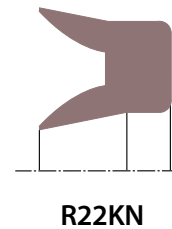
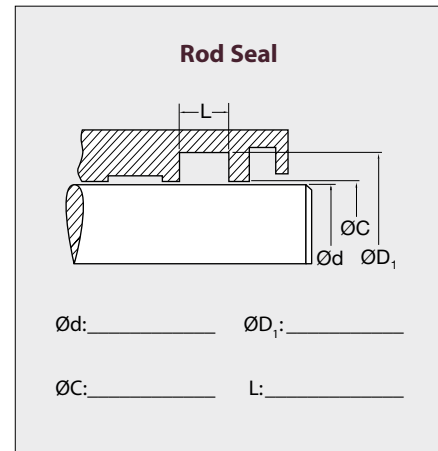
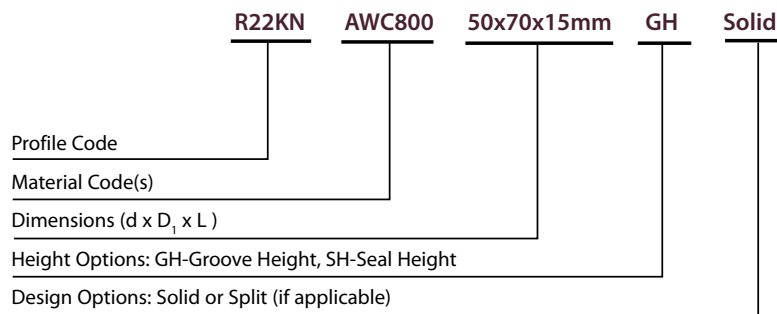

Catalog Legend

Designations used throughout this catalog

A Center piston landing area	G Wiper/seal lock groove depth
b Maximum extrusion gap	H Seal or wiper overall height
d Rod, shaft, or ram diameter	H₁ Bearing band height
d₁ Piston seal groove diameter	H₂ Flange thickness
d₂ Piston bearing band groove diameter	J Rod seal support clearance diameter
d₃ Wiper lock groove diameter	L Seal groove height
d₄ Hold down plate diameter	L₁ Wiper groove height
d₅ Piston clearance diameter	L₂ Bearing band groove height
d₆ L shaped, anti-extrusion ring leg inner diameter	L₃ Working stuffing box height
C Rod clearance diameter	L₄ L shaped, anti-extrusion ring leg height
c/s Cross section	M Inboard/outboard piston landing area
D Cylinder bore diameter	OR O-Ring
D₁ Rod seal groove diameter/stuffing box bore	P Piston seal support clearance diameter
D₂ Wiper housing lip clearance diameter	R Radius
D₃ Rod bearing band groove diameter	R_c Running clearance
D₄ Wiper groove diameter	S Cross section
D₅ Wiper lock groove	ID Inner diameter
E Overall piston head length	OD Outer diameter

Chesterton Polymer Seals Programs



Speed of Service

Dedicated Service Centers

Chesterton is a technology leader in the polymer seal industry. Our SpeedSeal™ capability brings same-day service of this advanced technology to customers worldwide. Strategically located and integrated service centers use innovative manufacturing methods to provide you with the broad selection of proven designs and wide range of high performance materials.

Superior Materials

World-Renowned AWC800 Polymer

Chesterton's world-renowned AWC800 material is widely considered to be the highest performing polyurethane material for heavy-duty fluid power applications on the market today. In addition, we utilize the full range of advanced materials for the most demanding applications.

- Polyurethanes
- Engineered plastics
- Fluoroplastics
- Elastomers (rubbers)



Engineered Solutions

High Performance Custom Seals

We leverage our engineering experience in design and materials to develop custom seals that solve today's most difficult sealing challenges. Our custom designs provide leading-edge technology that has been used around the world with documented success and recognition.



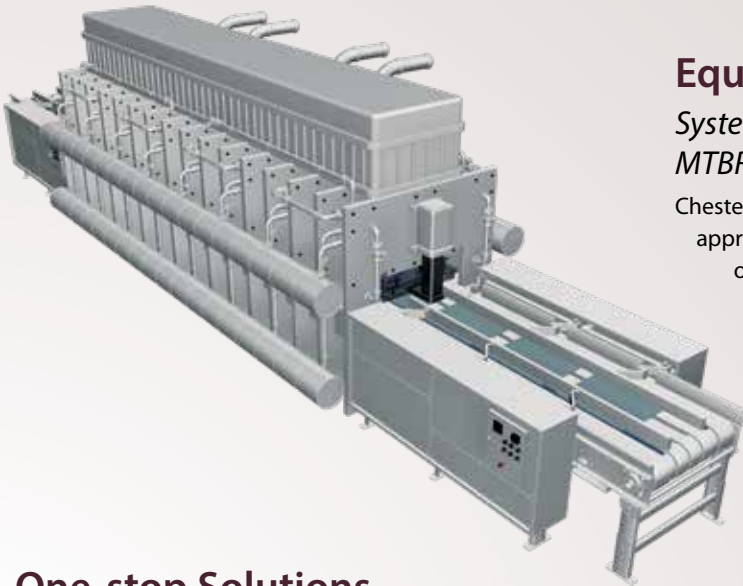

Equipment Upgrade

Systematic Approach to Improve MTBR and Reduce MTTR

Chesterton's equipment upgrade program applies a systematic approach for improving seal performance during repair and overhaul of equipment. This approach, in combination with high performance sealing products and systems, will assist to improve equipment reliability, availability, and performance productivity.

One-stop Solutions

Wide Range of Product Portfolio

We specialize in the development, design, and manufacture of system solutions tailor-made to customer's requirements. Polymer sealing products is the term to describe the broad range of sealing devices to provide sealing function in all types of fluid power and associated equipment in dynamic linear, rotational, and oscillating motion.



Customer Support

Global Solutions, Local Service

Chesterton's skilled field specialists work in collaboration with customers to understand their needs and provide the best solution for their applications. Our local service is supported by a global distribution and logistics network that enables us to reach and react to the shifting needs of industrial customers around the world.

Global Training Programs





























The Know-How Advantage

















Build a skilled workforce of fluid power equipment specialists by providing Chesterton's maintenance and operational best practices training to impact reliability, efficiency, and life cycle costs. Chesterton has been in the business of providing knowledge of this type for decades and can assist you with your training and development needs.



Polymer Seals Product Selection Guide

Please contact your local Chesterton Representative to help you select the best product for your application.

	Types	Speed	Product	Profile Series	Description	Attributes					Friction			Wear Resistance			
						Molded	*Machined	Hydraulic	Pneumatic	Split	Low	Mid	High	Low	Mid	High	
Reciprocating Motion	Cap Seals (Rod and Piston)	to 15 m/s (3000 ft/min)	RCCS		Double acting, dual component seal		●	●	●		●				●		
			PCCS		Double acting, dual component seal		●	●	●		●					●	
	Wipers		WCCS		Positive angled profile with flange		●	●	●	●	●					●	
			W21K		Positive angled profile with flange		●	●	●		●						●
	Rod Seals, U-Cups		R22KN		Single acting, positive angled profile		●	●	●		●					●	
			R22K		Single acting, radiused sealing surface for hydraulic applications		●		●			●		●			
			R23K		Single acting, radiused sealing surface for pneumatic applications		●		●		●			●			
	Rod Seals, Stacked Sets		R8K		Single acting, positive angled profile, multiple stacked set	●	●	●		●			●		●		
			R27K		Single acting, positive angled profile, multiple stacked set		●	●	●	●			●		●		
			R11K		Single acting, negative angled profile, dual stacked set	●	●	●		●		●			●		
			R28K		Single acting, positive angled profile, multiple stacked set		●	●		●			●		●		
			R28K1		Single acting, positive angled profile, multiple stacked set		●	●					●		●		
	Piston Seals, U-Cups	to 1 m/s (200 ft/min)	P22KN		Single acting, positive angled profile			●	●		●				●		
			P22K		Single acting, radiused sealing surface for hydraulic applications		●		●			●		●			
			P23K		Single acting, radiused sealing surface for hydraulic applications		●		●		●			●			
	Piston Seals, Stacked Sets		P8K		Single acting, positive angled profile, multiple stacked set	●		●		●			●		●		
			P27K		Single acting, positive angled profile, multiple stacked set		●	●		●			●			●	
			P28K		Single acting, positive angled profile, multiple stacked set		●	●		●			●		●		
			P28K1		Single acting, positive angled profile, multiple stacked set		●	●					●		●		
	Replaceable Bearings		16K, 17K, 18K, 19K		Metric and imperial English size bearing band and strips	●		●	●	●	●					●	
			WR		Custom bearing bands		●	●	●	●	●					●	
	Anti-Extrusion Rings		9K		Backup rings or anti-extrusion rings		●	●	●	●	●				●		
	Compression Seals (Rod and Piston)	to 0.75 m/s (150 ft/min)	R20K		Double acting, negative angled profile, low speed hydraulic applications		●	●					●		●		
			P20K		Double acting, negative angled profile, low speed hydraulic applications		●	●					●		●		
	Cantilever Spring Energized	to 5 m/s (1000 ft/min)	100 Series		Single acting with cantilever spring for highly dynamic applications		●	●	●		●					●	
	Elliptical Coil Spring Energized	to 6 m/s (1200 ft/min)	200 Series		Single acting with elliptical spring for large tolerances or miniature designs		●	●	●		●					●	
	Helical Wound Spring Energized	to 2.5 m/s (500 ft/min)	300 Series		Single acting with helical spring for static or slow speeds		●	●	●		●					●	
	Stacked Set		500 Series		Single acting, stacked sets		●									●	
Static	Valve Seals		M20K-OR		Static seal for O-Ring upgrades in hydraulic valves		●	●			●			●			

	Types	Speed	Product Series	Profile	Description	Attributes					Friction			Wear Resistance		
						Molded	*Machined	Bearing Protection	Stuffing Box	Split	Low	Mid	High	Low	Mid	High
Rotary Motion	Continuous Rotary Lip Seals	to 20 m/s (4000 ft/min)	30K		Single acting, low-pressure seal for bearing and gearbox protection		●	●			●					●
	Split Rotary Lip Seals	to 12.5 m/s (2500 ft/min)	33K		Single acting, non-pressure split seal for bearing and gearbox protection		●	●		●	●				●	
	Elliptical Coil Spring Energized	to 6 m/s (1200 ft/min)	200 Series		Single acting with elliptical spring for large tolerances or miniature designs		●	●	●			●				●
	Cantilever Coil Spring Energized	to 5 m/s (1000 ft/min)	100 Series		Single acting with cantilever spring for highly dynamic applications		●	●	●			●				●
	Helical Coil Spring Energized	to 2.5 m/s (500 ft/min)	300 Series		Single acting with helical spring for static or slow speeds		●	●	●				●			●
	Stacked Sets		500 Series		Single acting, stacked sets		●						●			
	Wipers	to 0.5 m/s (100 ft/min)	W21K		Positive angled profile with flange, slow rotary	●	●	●		●		●			●	
	Rod and Piston Seals		R22KN, P22KN		Single acting, positive angled profile, slow rotary	●	●	●	●	●		●			●	
	Rotary Lip Seal	0.5 m/s (100 ft/min)	R22KN5 ROT Split		Single acting, positive angled profile, slow rotary		●	●	●	●		●				●
	Rotary Face Seal	20 m/s (3937 ft/min)	50K		Face seal for dynamic rotary applications			●			●				●	
	Rotary Lip Seal	25 m/s (4921 ft/min)	51K		Single acting with helical garter spring, fabric reinforced back	●		●		●		●			●	
	Rotary Lip Seal		52K		Single acting with helical garter spring, metallic stiffener ring	●		●				●			●	
	Rotary Lip Seal	35 m/s (6889 ft/min)	53K		Single acting with garter/finger spring, metallic outer case	●		●			●				●	
	Cartridge Seal	5 m/s (984 ft/min)	30KC		Polymer cartridge with inboard, outboard sealing elements, and built-in flushing port		●		●							●
	Restriction Bushing	—	14K		Split, single acting with tapered lip seal		●		●	●						●
Labyrinth Seal	30.5 m/s (6000 ft/min)	PLS		Polymer non-contacting labyrinth seal		●	●			●				●		

Ratings on this chart are for reference only. Values may be higher or lower depending upon the application details such as surface finish, hardness, lubrication, and concentricity. Jacket/spring combinations will also affect these values.

*Machined product does not require tooling.

Sealing Technology

Fluid Power Sealing Technology

Cylinder Upgrade—Solutions Approach

The Chesterton cylinder upgrade program applies a systematic solutions approach for improving seal performance during the repair and overhaul of equipment. Working in partnership with you, we offer a unique approach to total cylinder refitting that saves money and delivers a better, more reliable cylinder back to your plant.

- Minimize downtime and maintenance cost
- Improve equipment reliability
- Extend leak-free service life
- Reduce hydraulic fluid consumption and support fluid management efforts



Gland

Pressure Port

Piston Rod

Cylinder Jacket/Tube

Piston Head

Cap End Head



Wiper

The function of a wiper is to effectively clean and to dislodge foreign matter from a reciprocating rod/ram to prevent contaminants from entering the system.



Rod Seal

The function of a rod seal is to act as a pressure barrier and prevent fluid bypass along the dynamic (rod/ram) surface and the static (stuffing box bore) surface under various operating conditions. It regulates the fluid film during extension of the cylinder rod.



Buffer Seal

The buffer seal reduces the impact of pressure spikes on the secondary rod seal while the vented slots minimize the possibility of trapped pressure between itself and the rod seal.



Wear Ring

These split, replaceable bearings prevent metal-to-metal contact of moving parts and help prolong equipment and seal life. These bearings reduce radial movement, therefore extending seal life and reducing the risk of reoccurring damage.



Piston Seal

The function of a piston seal is to prevent fluid bypass between the piston head and cylinder bore under various operating conditions and to act as a pressure barrier. It helps to maintain system efficiency and plays an important role in controlling the cylinder motion and maintaining position.



Trash Ring

This ancillary device functions as the first line of defense for piston seals and wear rings by absorbing contaminants in the system, thus helping to protect the sealing components and extend maintenance intervals.

W21K Wiper Seals

Protect the System from Entering Contaminants

Chesterton positive rake wipers are designed to effectively clean and dislodge foreign matter from retracting rods or rams thus preventing scoring and system contamination. The sharp, rugged, flared profile provides protection against abrasive particles which can contaminate the system and lead to premature equipment failure. These wipers provide excellent performance on rods or rams in hydraulic and pneumatic applications.

Single- and double-acting wiper designs are available thus providing the best possible function and performance, depending on the application, operating conditions, and utilized seal system. Single-acting wiper seal's function is to keep out contamination from the operating environment. Double-acting wiper seals wipe off the possible residual oil film from the rod, reducing the risk of hydraulic media's external leakage.

The 21K design is manufactured using a machining process which allows for the flexibility to create any size based on equipment dimensions. This design incorporates a built-in static seal on the flange to block contaminants from migrating along the stationary side of the wiper during operation.

Additional custom designs were developed to meet specific application and equipment needs which include snap-in, stepped, and bidirectional wipers.



- Positive rake lip design effectively wipes contaminants away from surface
- Outstanding protection against ingress of particles into the system
- Prolongs service life of seals and hydraulic/pneumatic cylinders
- Manufacturing process allows flexibility to create any size
- Sizes made to accommodate international standards including ISO

SPECIFICATIONS



Material (designation)	Size Range* mm (inch)	Temperature °C (°F)	Speed m/s (ft/min)
AWC704 (FKM)	6 – 304.8 (1/4 – 12)	-30 – 200 (-20 – 400)	1.5 (300)
AWC800 (EU)	6 – 2540 (1/4 – 100)	-50 – 85 (-60 – 185)	1 (200)
AWC808 (AU)	6 – 400 (1/4 – 15.75)	-20 – 85 (-4 – 185)	0.5 (100)
AWC825 (EU)	6 – 2540 (1/4 – 100)	-40 – 85 (-40 – 185)	0.5 (100)
AWC830 (EU)	6 – 254 (1/4 – 10)	-35 – 75 (-30 – 175)	0.9 (185)
AWC860 (EU)	6 – 508.0 (1/4 – 20)	-50 – 120 (-60 – 250)	1.25 (250)

*Please contact your Chesterton representative for larger sizes.

Applicable standards: ISO 6195A, ISO 6195C

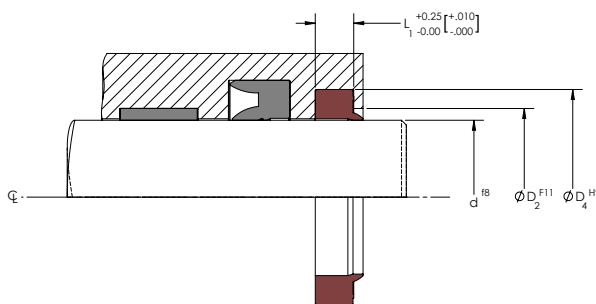

PRODUCT PROFILES

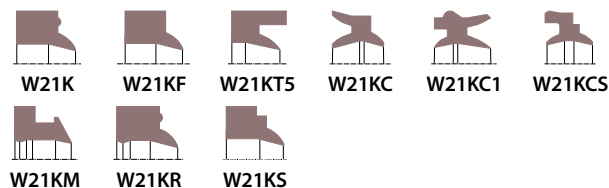

CW21K Canned Wiper Seals

Protect the System from Entering Contaminants

Chesterton positive rake wipers effectively clean and dislodge foreign matter from retracting rods or rams thus mitigating scoring and system contamination in open cavity designs. These wipers provide excellent performance for hydraulic applications.

Canned wiper seals require an open, easy construction groove. It helps to simplify gland design, layout, and manufacturing. Another advantage is the possible space savings, as shorter space is required for canned wipers.

The CW21K is manufactured from a machining process which allows the flexibility to create any size based on equipment dimensions. The canned portion of the seal provides stability due to an interference fit that allows it to be pressed into an open cavity gland design.

These wipers are available in various material combinations based on equipment requirements while the canned portion of the seal can be manufactured from metallic material and other engineered plastics.

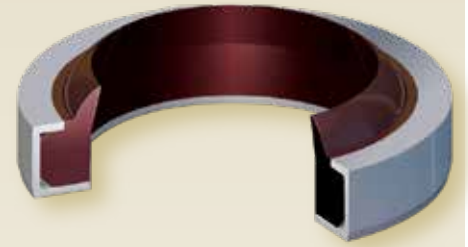

- Interference press-fit design does not require support of other external devices
- Space saving and easy, open construction groove
- Single-acting, abrasion-resistant design for hydraulic applications
- Positive rake lip design effectively wipes contaminants away from surface
- Manufacturing process allows flexibility to create any size

SPECIFICATIONS



Material (designation)	Size Range* mm (inch)	Temperature °C (°F)	Speed m/s (ft/min)
AWC704 (KFM)	6 – 304.8 (1/4 – 12)	-30 – 200 (-20 – 400)	1.5 (300)
AWC800 (EU)	6 – 1320 (1/4 – 52)	-50 – 85 (-60 – 185)	1 (200)
AWC808 (AU)	6 – 400 (1/4 – 15.75)	-20 – 85 (-4 – 185)	0.5 (100)
AWC825 (EU)	6 – 1320 (1/4 – 52)	-40 – 85 (-40 – 185)	0.5 (100)
AWC830 (EU)	6 – 254 (1/4 – 10)	-35 – 75 (-30 – 175)	0.9 (185)
AWC860 (EU)	6 – 508.0 (1/4 – 20)	-50 – 120 (-60 – 250)	1.25 (250)

*Please contact your Chesterton representative for larger sizes.

Applicable standard: ISO 6195B

Can material options: AWC650-POM, AWC663-PA6, AWC665-PA6+MoS2, Aluminum, Stainless Steel

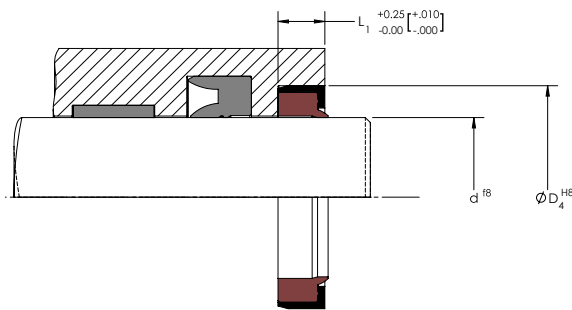

PRODUCT PROFILES

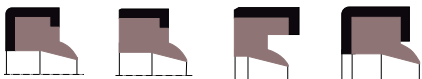

CW21K CW21K1 CW21K2 CW21K3

WCCS Wiper Seals

Double-acting Wipers for Hydraulic and Pneumatic Applications

Chesterton WCCS double-acting wiper seals effectively clean and dislodge foreign matter from retracting rods or rams thus preventing scoring and system contamination. The robust profile provides protection against abrasive particles which can contaminate the system and lead to premature equipment failure. These wipers provide excellent performance on rods or rams in hydraulic and pneumatic applications. Another function of the WCCS wipers is to obstruct residual oil film on rod and ram thus reducing risk of external leakage of hydraulic media.

WCCS wipers utilize a built-in O-Ring, which provides optimum lip pressure of the wiper on the sliding surface in all operating conditions. The O-Ring helps to compensate either possible side movement or deflection of the rod/ram, maintaining a wiping effect in most of the equipments physical conditions. Excellent sliding properties of the WCCS design will assist in reducing friction and avoiding stick-slip effect.

The WCCS design is manufactured using a machining process which allows the flexibility to create any size based on equipment dimensions. This design incorporates a built-in static seal on the flange to ensure contaminants do not migrate along the stationary side of the wiper during operation. Additional custom designs may be developed to meet specific application and equipment needs.



SPECIFICATIONS

Material (designation)	Size Range* mm (inch)	Temperature °C (°F)	Speed m/s (ft/min)
**AWC800 (EU)	6 – 1320 (1/4 – 52)	-50 – 85 (-60 – 185)	1 (200)
**AWC808 (AU)	6 – 400 (1/4 – 15.75)	-20 – 85 (-4 – 185)	0.5 (100)
**AWC830 (EU)	6 – 254 (1/4 – 10)	-35 – 75 (-30 – 175)	0.9 (185)
**AWC860 (EU)	6 – 508.0 (1/4 – 20)	-50 – 120 (-60 – 250)	1.25 (250)
***AWC300 (Glass-Filled PTFE)	up to 600 (24)	-35 – 120 (-30 – 250)	15 (3000)
***AWC400 (Carbon-Filled PTFE)	up to 600 (24)	-35 – 120 (-30 – 250)	15 (3000)
***AWC500 (Bronze-Filled PTFE)	up to 600 (24)	-35 – 120 (-30 – 250)	15 (3000)
***AWC520 (Virgin PTFE)	up to 600 (24)	-35 – 120 (-30 – 250)	15 (3000)

*Please contact your Chesterton representative for larger sizes ** O-Ring material is NBR *** O-Ring material is FKM
Applicable standards: ISO 6195D

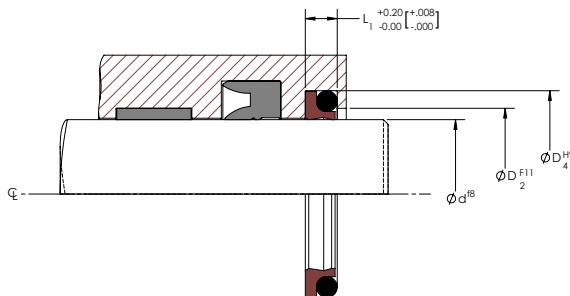

PRODUCT PROFILES



WCCS



- Robust lip design effectively wipes contaminants away from surface
- Obstruct residual oil film on media side
- Excellent sliding properties for reduced friction and stock slip-free operation
- Manufacturing process allows flexibility to create any size
- Sizes made to accommodate international standards including ISO

R6K Rod Seals

Rugged Construction for Older, Worn Equipment

The Chesterton 6K is a single-acting, continuous U-Cup design for medium-to-heavy-duty applications with a positive rake lip design that wipes contaminants away from the mating surface while in operation. The robust, fabric reinforced, rubber-based construction is ideal for older, worn equipment since it conforms to surface irregularities to effectively control leakage in a wide variety of applications. This rod seal design provides outstanding performance in older, worn hydraulic cylinders and presses.

The seal lips are preloaded by the seal groove when installed to ensure tight sealing even at low pressure. When the system pressure increases the hydraulic fluid energizes the seal lips, increasing the sealing area and sealing efficiency of the component.

The surface of the seal has pockets that retain hydraulic fluid for lubrication on the dynamic surface, reducing friction and wear.

The 6K is made from a custom molding process that utilizes existing tooling. Each seal is individually manufactured from a base rubber-reinforced material. Neoprene-based compounds perform well in water and oil, while butyl-based material is recommended for phosphate ester fluids.

SPECIFICATIONS



Material (designation)	Size Range* mm (inch)	Temperature °C (°F)	Pressure MPa (psi)	Speed m/s (ft/min)
AWC735 Neoprene (NR)	100 – 1,143 (4 – 45)	-25 – 121 (-13 – 250)	207 (3000)	0.6 (120)
AWC747 Butyl (IIR)	100 – 1,143 (4 – 45)	-25 – 121 (-13 – 250)	207 (3000)	0.6 (120)

*Please contact your Chesterton representative for larger sizes ** O-Ring material is NBR *** O-Ring material is FKM
Applicable standards: ISO 5597

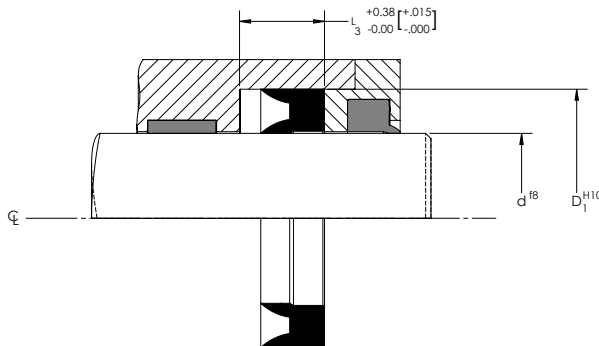

- Positive rake profile wipes contaminants away from the mating surface
- Rugged base construction designed for older, worn equipment
- Rubber-based material conforms to surface irregularities to control leakage
- Robust construction is able to withstand pressure shock from press bumping and shock load

PRODUCT PROFILES



R6K

R22K Rod Seals

Special Geometry Provides Optimal Sealing Performance

The Chesterton R22K is a single-acting, asymmetric, continuous U-Cup design. A unique seal lip geometry in combination with twin lip arrangement on the dynamic side provides zero leakage throughout the entire operating range, resulting in tight, dry rod sealing operation. The sturdy, static lip stabilizes the seal to prevent rolling while the dynamic lip design mitigates issues associated with low-pressure sealing, provides additional stability, and eases installation.

The optimum seal design enables controlled pressure distribution through the entire seal component, while the proper expansion space provides free space for deformation under pressure, optimizing seal contact area on the sliding surface.

This seal design is offered as a rod seal and provides excellent performance in light-to heavy-duty hydraulic applications. Robust seal construction makes R22K insensitive to pressure fluctuation and in combination with high performance polyurethane materials, has outstanding pressure/shock load capability.

The 22K design is manufactured using a machining process which allows the flexibility to create any size based on equipment dimensions. A number of additional designs have been derived from the original R22K design to address specific needs and applications in the market. These include the use of anti-extrusion rings for use in equipment with excessive clearances.



- Single-acting, U-Cup design, zero leakage throughout the entire operating range
- Abrasion-resistant design; excellent performance in hydraulic applications
- Insensitive to pressure fluctuation and excellent pressure/shock load capability
- Machining process allows the flexibility to create any size
- Sizes made to accommodate international standards including ISO

SPECIFICATIONS



Material (designation)	Size Range* mm (inch)	Temperature °C (°F)	Pressure MPa (psi)	Speed m/s (ft/min)
AWC704 (FKM)	6 – 304.8 (1/4 – 12)	-30 – 200 (-20 – 400)	16 (2320)	1.5 (300)
AWC800 (EU)	6 – 2540 (1/4 – 100)	-50 – 85 (-60 – 185)	103.5 (15000)	1 (200)
AWC808 (AU)	6 – 400 (1/4 – 15.75)	-20 – 85 (-4 – 185)	40 (5800)	0.5 (100)
AWC825 (EU)	6 – 2540 (1/4 – 100)	-40 – 85 (-40 – 185)	52 (7500)	0.5 (100)
AWC830 (EU)	6 – 254 (1/4 – 10)	-35 – 75 (-30 – 175)	52 (7500)	0.9 (185)
AWC860 (EU)	6 – 508.0 (1/4 – 20)	-50–120 (-60 – 250)	103.5 (15000)	1.25 (250)

*Please contact your Chesterton representative for larger sizes.
Applicable standard: ISO 5597

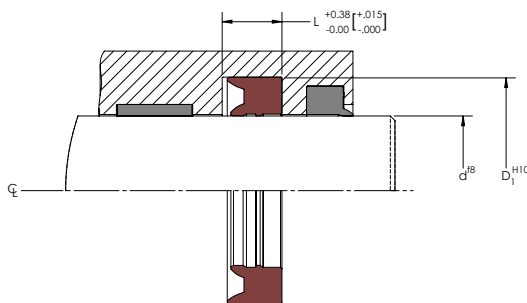

PRODUCT PROFILES



R22KN Rod Seals

Low Friction Design for Hydraulic and Pneumatic Sealing

Chesterton R22KN are single-acting, continuous U-Cup designs. The special lip design provides an optimal amount of radial sealing load with excellent tribological and sealing characteristics thus resulting in minimal frictional resistance and low heat generation. Utilization of R22KN U-Cup assists to reduce breakaway force and dynamic frictional force during operation.

The optimum seal design facilitates controlled pressure distribution through the entire seal component, while the proper expansion space provides free space for deformation under pressure, optimizing seal contact area on the sliding surface.

The positive rake lip profile wipes contaminants away from the mating surface while in operation thus prolonging seal and equipment service life. This seal design is offered as a rod seal and provides outstanding performance in light-to heavy-duty hydraulic and pneumatic applications.

The 22KN design is manufactured using a machining process which allows the flexibility to create any size based on equipment dimensions. A number of unique designs have been derived from the original R22KN to address specific needs and applications in the market. These include designs to address pressure reversal, pressure spikes, and system vacuuming.



- Single-acting, U-Cup design minimizes frictional resistance and breakaway force
- Positive rake lip design wipes contaminants away from mating surface
- Abrasion-resistant design; outstanding performance in hydraulic and pneumatic applications
- Manufacturing process allows flexibility to create any size
- Sizes made to accommodate international standards including ISO

SPECIFICATIONS



Material (designation)	Size Range* mm (inch)	Temperature °C (°F)	Pressure MPa (psi)	Speed m/s (ft/min)
AWC704 (FKM)	6 – 304.8 (1/4 – 12)	-30 – 200 (-20 – 400)	16 (2320)	1.5 (300)
AWC800 (EU)	6 – 2540 (1/4 – 100)	-50 – 85 (-60 – 185)	103.5 (15000)	1 (200)
AWC808 (AU)	6 – 400 (1/4 – 15.75)	-20 – 85 (-4 – 185)	40 (5800)	0.5 (100)
AWC825 (EU)	6 – 2540 (1/4 – 100)	-40 – 85 (-40 – 185)	52 (7500)	0.5 (100)
AWC830 (EU)	6 – 254 (1/4 – 10)	-35 – 75 (-30 – 175)	52 (7500)	0.9 (185)
AWC860 (EU)	6 – 508.0 (1/4 – 20)	-50 – 120 (-60 – 250)	103.5 (15000)	1.25 (250)

* Please contact your Chesterton representative for larger sizes.
Applicable standard: ISO 5597

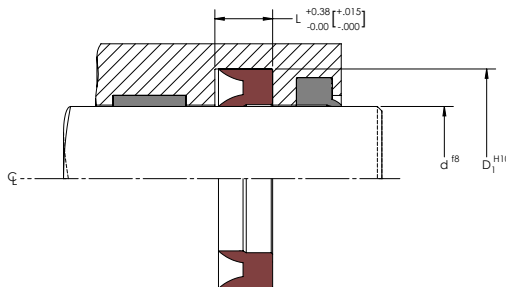

PRODUCT PROFILES

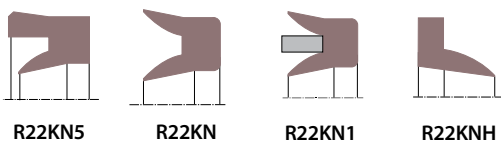

R22KE Rod Seals

Special Geometry Provides Optimal Sealing Performance

The Chesterton R22KE is a single-acting, continuous U-Cup design which incorporates the use of an O-Ring to increase preload capabilities. The O-Ring energizes the seal in the absence of system pressure, helps to increase sealing force thus inhibiting hydraulic media bypass, and provides stability at higher temperature conditions. System pressure rise will increase sealing force, completely actuating the lips through the O-Ring.

The excellent resistance to abrasion and trimmed seal lips provides outstanding performance in medium- to heavy-duty hydraulic applications. The rubber energizer cushions the seal against shock load and pressure peaks. Incorporated anti-extrusion ring helps the seal to withstand transverse loads and extreme pressure conditions during operation and further increases extrusion resistance of the seal component at larger clearances. This seal design is offered as a rod seal.

The R22KE design is manufactured using a machining process which allows the flexibility to create any size based on equipment dimensions.



- Single-acting U-cup design; zero leakage throughout the entire operating range
- O-Ring loader energizes seal and provides stability at higher pressures
- Abrasion-resistant design; excellent performance in hydraulic applications
- High resistance against transverse load, pressure peaks, and extrusion
- Machining process allows the flexibility to create any size

SPECIFICATIONS



Material (designation)	Size Range* mm (inch)	Temperature °C (°F)	Pressure MPa (psi)	Speed m/s (ft/min)
AWC704 (FKM)	6 – 304.8 (1/4 – 12)	-30 – 200 (-20 – 400)	16 (2320)	1.5 (300)
AWC800 (EU)	6 – 1320 (1/4 – 52)	-50 – 85 (-60 – 185)	103.5 (15000)	1 (200)
AWC808 (AU)	6 – 400 (1/4 – 15.75)	-20 – 85 (-4 – 185)	40 (5800)	0.5 (100)
AWC825 (EU)	6 – 1320 (1/4 – 52)	-40 – 85 (-40 – 185)	52 (7500)	0.5 (100)
AWC830 (EU)	6 – 254 (1/4 – 10)	-35 – 75 (-30 – 175)	52 (7500)	0.9 (185)
AWC860 (EU)	6 – 508.0 (1/4 – 20)	-50 – 120 (-60 – 250)	103.5 (15000)	1.25 (250)

*Please contact your Chesterton representative for larger sizes.
Applicable standard: ISO 5597

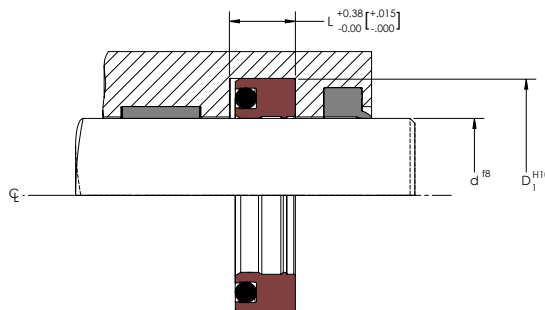

PRODUCT PROFILES



R22KE



R22KEAER



R22KEAER1

R23K Rod Seals

Optimum Geometry for Pneumatic Sealing

The Chesterton R23K seal is a single-acting, U-Cup design that incorporates a unique, dynamic lip geometry that provides the optimal sealing force required for low-pressure pneumatic rod applications. Radiused lip and lower lip preload produces a continuous lubrication film which minimizes frictional force, heat generation, and wear. This unique sealing characteristic helps to reduce breakaway and frictional force during operation, significantly improving seal and equipment service life and reliability. Increased lip groove of the U-profile improves seal flexibility.

The use of high performance, wear-resistant, thermoset polyurethanes instead of rubber compounds will help to reduce wear and increase seal life even in improperly lubricated air.

The R23K design is manufactured using a machining process which allows the flexibility to create any size based on equipment dimensions.



- Unique lip geometry provides optimal sealing force for pneumatic applications
- Radiused lip and lower preload design enables a continuous lubricating film, minimizing wear
- Reduced breakaway and frictional force
- Machining process allows the flexibility to create any size
- Sizes made to accommodate international standards including ISO

SPECIFICATIONS



Material (designation)	Size Range* mm (inch)	Temperature °C (°F)	Pressure MPa (psi)	Speed m/s (ft/min)
AWC704 (FKM)	6 – 304.8 (1/4 – 12)	-30 – 200 (-20 – 400)	16 (2320)	1.5 (300)
AWC800 (EU)	6 – 2540 (1/4 – 100)	-50 – 85 (-60 – 185)	103.5 (15000)	1 (200)
AWC808 (AU)	6 – 400 (1/4 – 15.75)	-20 – 85 (-4 – 185)	40 (5800)	0.5 (100)
AWC825 (EU)	6 – 2540 (1/4 – 100)	-40 – 85 (-40 – 185)	52 (7500)	0.5 (100)
AWC830 (EU)	6 – 254 (1/4 – 10)	-35 – 75 (-30 – 175)	52 (7500)	0.9 (185)
AWC860 (EU)	6 – 508.0 (1/4 – 20)	-50 – 120 (-60 – 250)	103.5 (15000)	1.25 (250)

* Please contact your Chesterton representative for larger sizes.
Applicable standard: ISO 5597

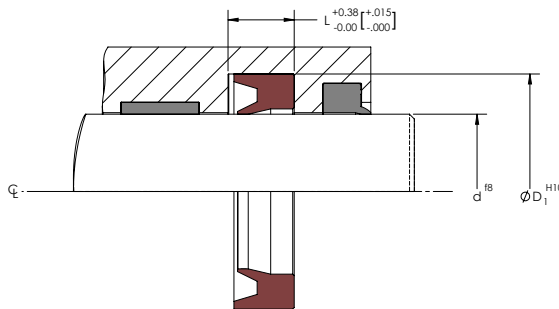

PRODUCT PROFILES



R23K

R11K Rod Seals

Split, dual-Component Stacked Set for Hydraulic Sealing

The Chesterton patented 11K EZ Stack Pack is a single-acting, two-piece split stacked set that employs a negative rake lip profile to optimize operating performance while easing installation into the stuffing box cavity. The unique, split design, made up of two components, eliminates the need for equipment disassembly and shimming and is recommended for use in hydraulic cylinders and presses.

The bottom ring is the primary sealer while the top ring provides secondary sealing and works as an anti-extrusion ring. The set is available in various material combinations to accommodate new or used equipment and can be supplied in split or solid designs.

The 11K EZ Stack Pack can be manufactured using either the traditional compression molded process or a machining process which allows for the flexibility to create any size based on equipment dimensions.

Application tailored systems can be built with the 11K in combination with Chesterton 9K Anti-Extrusion Ring and/or with Spacer and Stand-Off Ring. This adaptive module system allows you to create the most suitable seal kit for all kinds of heavy-duty and demanding hydraulic cylinder applications and operating conditions. Flexible, modular, and custom tailored systems are optimum solutions for replacement of conventional heavy-duty stacked sets.

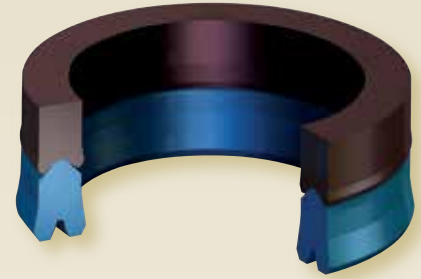

- Replaces the stacked set assemblies
- One optimized seal concept for different press applications
- Patented split design eliminates the need to disassemble equipment
- Negative lip profile optimizes operating performance and eases installation
- No shimming; eliminates tedious calculations and future adjustments
- Dual material combination works on both new and worn equipment

SPECIFICATIONS



Material (designation)	Size range* mm (inch)	Temperature °C (°F)	Pressure MPa (psi)	Speed m/s(ft/min)
AWC704 (FKM)	6 – 304.8 (1/4 – 12)	-30 – 200 (-20 – 400)	16 (2320)	1.5 (300)
AWC800 (EU)	6 – 2540 (1/4 – 100)	-50 – 85 (-60 – 185)	103.5 (15000)	1 (200)
AWC805 (EU)	6 – 2540 (1/4 – 100)	-50 – 85 (-60 – 185)	103.5 (15000)	0.5 (100)
AWC808 (AU)	6 – 400 (1/4 – 15.75)	-20 – 85 (-4 – 185)	40 (5800)	0.5 (100)
AWC825 (EU)	6 – 2540 (1/4 – 100)	-40 – 85 (-40 – 185)	52 (7500)	0.5 (100)
AWC830 (EU)	6 – 254 (1/4 – 10)	-35 – 75 (-30 – 175)	52 (7500)	0.9 (185)
AWC860 (EU)	6 – 508.0 (1/4 – 20)	-50 – 120 (-60 – 250)	103.5 (15000)	1.25 (250)

* Please contact your Chesterton representative for larger sizes.
Applicable standard: ISO 5597

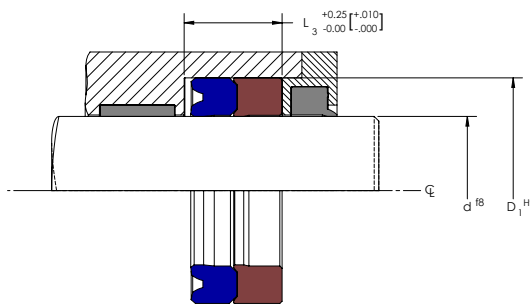

PRODUCT PROFILES

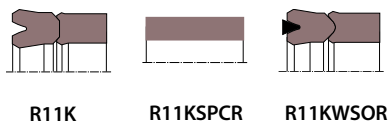

11K IN PRESS APPLICATION



MODULAR SEAL SYSTEM EXAMPLES

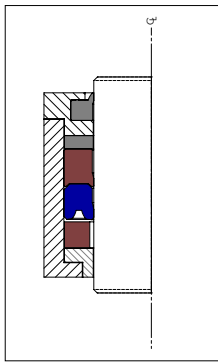

9K Anti-Extrusion Ring
11K Dual Split Seal
Spacer

Large stuffing box depth. Back-up ring (9K) protects seal (11K) against extrusion, while spacer fills up the axial space in front of the seal set.

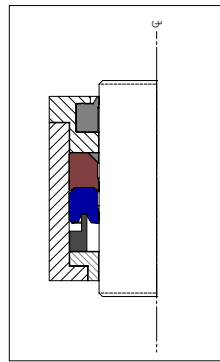

9K Integrated Anti-Extrusion Ring
11K Dual Split Seal
Stand-off Ring

Multi-component system design for short stuffing boxes, where integrated back-up ring is against extrusion. Stand-off ring supports the seal and keeps it in position (in case of floating bushing, or in vacuum).

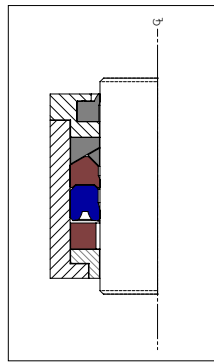

Self-aligning Gland Adapter Ring
11K Dual Split Seal
Spacer

Large stuffing box depth. Customized self-aligning gland ring provides superior resistance against extrusion in case of large extrusion gap (worn bushings, worn rams).

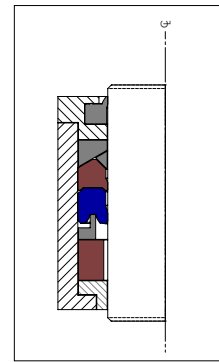

Self-aligning Gland Adapter Ring
11K Dual Split Seal
Stand-off Ring
Spacer

Multi-component system for replacement of traditional packing set with extra large stuffing box depth. Spacer is in combination with stand-off ring, keeping the seal in position, while self-aligning gland ring protects seal against extrusion in case of large extrusion gap. (Typical applications: worn horizontal press cylinders).

R600 Rod Seals

Gland-Sensitive, Stacked Set for Older, Worn Equipment

Chesterton 600 is a single-acting, stacked V-Ring set that enables the gland force transfer pressure to ensure each ring loads evenly. The 600 series is used in heavy-duty, hydraulic applications and offers outstanding performance and long service life in most difficult operating conditions such as misalignment or pressure peaks. The seal assembly consists of a male adapter and seal rings. The special seal ring design makes the female adapter unnecessary, helping to reduce friction generation.

The rugged, rubber-based construction is ideal for older, worn equipment since it conforms to surface irregularities to effectively control leakage. This seal set provides outstanding performance in hydraulic cylinders or presses, thanks to material strength and durability. The surface of the seal has pockets that retain hydraulic fluid for lubrication on the dynamic surface thus reducing friction and wear.

It is particularly adaptable to deep stuffing boxes and odd size rams where equipment cannot be disassembled.

The 600 is traditionally a compression molded, stacked seal set which utilizes tooling to create a final product. The sets are available in split or continuous configurations.

Each seal ring is individually manufactured with a flat landing to ensure gland load is transferred through the set upon tightening. A male bottom adapter is designed to provide even loading, centering, and support.

SPECIFICATIONS



Material (designation)	Size Range mm (inch)	Temperature °C (°F)	Pressure MPa (psi)	Speed m/s (ft/min)
AWC735 Neoprene (NR)	12.7 – 914 (1/2 – 36)	-25 – 121(-13 – 250)	34.5 (5000)	0.6 (120)
AWC747 Butyl (IIR)	12.7 – 914 (1/2 – 36)	-25 – 121(-13 – 250)	34.5 (5000)	0.6 (120)

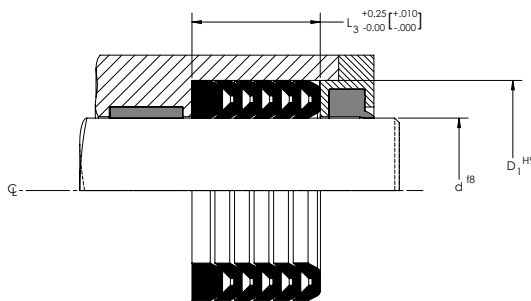

PRODUCT PROFILES



R600



- Rubber-based materials conform to surface imperfections to control leakage
- Misalignment and pressure peak handling capabilities
- Neoprene-based materials perform well in water and oil
- Butyl-based materials perform well in phosphate ester fluids
- Split design; ease of installation and shorter installation time required

RECOMMENDED NUMBER OF SEAL RINGS AND ADAPTERS REQUIRED BASED ON PRESSURE

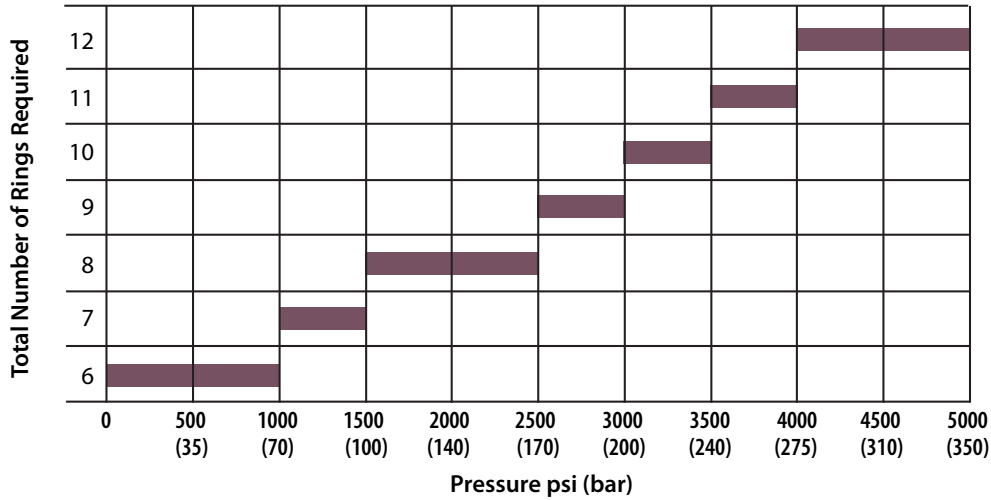

Note: For pressure 3000 psi (200 bar) and above we suggest the use of an anti-extrusion ring.

600 STACKED V-RING APPROXIMATE FREE STACK HEIGHT CHART

Stack height per set, including one bottom ring rounded down to the nearest 1/16 inch (1.6mm) per inch of depth

Number of Rings	4 Rings	5 Rings	6 Rings	7 Rings	8 Rings	9 Rings	10 Rings	11 Rings	12 Rings
Cross Section mm (inch)	mm (inch)	mm (inch)	mm (inch)	mm (inch)	mm (inch)	mm (inch)	mm (inch)	mm (inch)	mm (inch)
4.75 (0.187)	17.45 (0.687)	22.23 (0.875)	25.40 (1.000)	30.15 (1.187)	34.93 (1.375)	39.70 (1.563)	42.88 (1.688)	47.63 (1.875)	52.40 (2.063)
6.35 (0.250)	20.62 (0.812)	41.28 (1.625)	31.75 (1.250)	36.50 (1.437)	41.28 (1.625)	47.63 (1.875)	52.40 (2.063)	57.15 (2.250)	61.93 (2.438)
7.92 (0.312)	25.40 (1.000)	31.75 (1.250)	36.50 (1.437)	42.85 (1.687)	49.23 (1.938)	55.58 (2.188)	60.33 (2.375)	66.68 (2.625)	73.02 (2.875)
9.53 (0.375)	25.40 (1.000)	31.75 (1.250)	36.50 (1.437)	42.85 (1.687)	49.23 (1.938)	55.58 (2.188)	60.33 (2.375)	66.68 (2.625)	73.02 (2.875)
11.10 (0.437)	28.58 (1.125)	34.93 (1.375)	41.28 (1.625)	49.20 (1.937)	55.58 (2.188)	61.93 (2.438)	68.28 (2.688)	76.20 (3.000)	82.55 (3.250)
12.70 (0.500)	28.58 (1.125)	34.93 (1.375)	41.28 (1.625)	49.20 (1.937)	55.58 (2.188)	61.93 (2.438)	68.28 (2.688)	76.20 (3.000)	82.55 (3.250)
14.27 (0.562)	31.75 (1.250)	39.67 (1.562)	47.63 (1.875)	55.58 (2.188)	61.93 (2.438)	69.85 (2.750)	77.80 (3.063)	85.72 (3.375)	92.07 (3.625)
15.88 (0.625)	36.50 (1.437)	44.45 (1.750)	52.37 (2.062)	61.90 (2.437)	69.85 (2.750)	77.80 (3.063)	85.72 (3.375)	95.25 (3.750)	103.20 (4.063)
17.45 (0.687)	39.67 (1.562)	49.20 (1.937)	57.15 (2.250)	66.68 (2.625)	76.20 (3.000)	85.72 (3.375)	93.70 (3.688)	103.20 (4.063)	112.73 (4.438)
19.05 (0.750)	42.85 (1.687)	53.97 (2.125)	63.50 (2.500)	73.02 (2.875)	82.55 (3.250)	93.68 (3.688)	103.20 (4.063)	112.73 (4.438)	122.25 (4.813)
20.62 (0.812)	46.02 (1.812)	57.15 (2.250)	68.25 (2.687)	79.38 (3.125)	88.98 (3.503)	100.03 (3.938)	111.10 (4.375)	122.25 (4.813)	131.78 (5.188)
22.23 (0.875)	50.80 (2.000)	61.90 (2.437)	74.60 (2.937)	85.72 (3.375)	96.82 (3.812)	107.95 (4.250)	119.10 (4.689)	131.75 (5.187)	142.88 (5.625)
23.80 (0.935)	53.97 (2.125)	66.68 (2.625)	79.38 (3.125)	92.07 (3.625)	103.20 (4.063)	115.90 (4.563)	128.60 (5.063)	141.30 (5.563)	152.4 (6.000)
25.40 (1.000)	57.15 (2.250)	71.42 (2.812)	84.12 (3.312)	96.82 (3.812)	109.55 (4.313)	123.83 (4.875)	136.50 (5.375)	149.23 (5.875)	163.53 (6.438)

Notes: Use the pressure chart to determine minimum number of seals required. Seals are supplied split unless otherwise stated.

R8K Rod Seals

Pressure-sensitive, Stacked Set for Hydraulic Sealing

The Chesterton 8K is a single-acting, stacked V-Ring set with a positive rake design to provide optimum operating performance in heavy-duty hydraulic rod applications. Unlike conventional stacked sets, these designs make contact through the center to enable even loading which minimizes friction and provides longer sealing life.

The minimal gland pressure enables these sets to withstand greater sliding speed than conventional stacked sets. No readjustment of the seal precompression is needed after installation. Flared, pressure-sensitive lip design provides optimum sealing forces on seal rings, which are reactive to pressure thus reducing breakaway and frictional force.

The set is available in various material combinations to accommodate new or used equipment and can be supplied in split or solid designs.

The 8K is a compression molded, stacked set that utilizes tooling to create a final product. Each set incorporates a male and female adapter to align and support the seal rings.

Additional profiles have been derived from the original 8K design to address specific needs and applications in the market. These include designs for excessive clearances and deep stuffing boxes.

SPECIFICATIONS



Material (designation)	Size Range* mm (inch)	Temperature °C (°F)	Pressure MPa (psi)	Speed m/s (ft/min)
AWC800 (EU)	6 – 1778 (1/4 – 70)	-50 – 85 (-60 – 185)	103.5 (15000)	1 (200)
AWC805 (EU)	6 – 1016 (1/4 – 40)	-50 – 85 (-60 – 185)	103.5 (15000)	0.5 (100)

*Please contact your Chesterton representative for larger sizes.

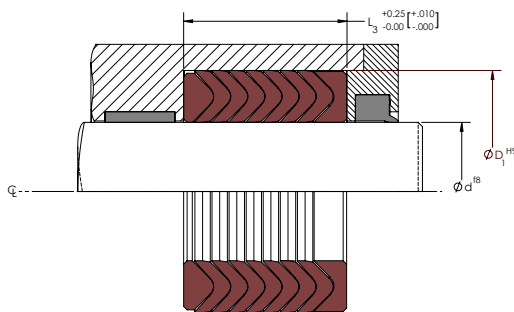

PRODUCT PROFILES

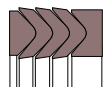

R8K



- Minimal gland pressure offers greater speed capability than conventional sets
- Even stack load design minimizes friction and extends service life
- Flared, pressure-sensitive lip; sealing forces are reactive to pressure
- Material combinations for use in both new and worn equipment
- Delivered as split components for ease of installation

Determine the total number of seals required (including top and bottom adapters) from the chart below.

CHART 1 – R8K FLUID PRESSURE – SEAL RING CHART

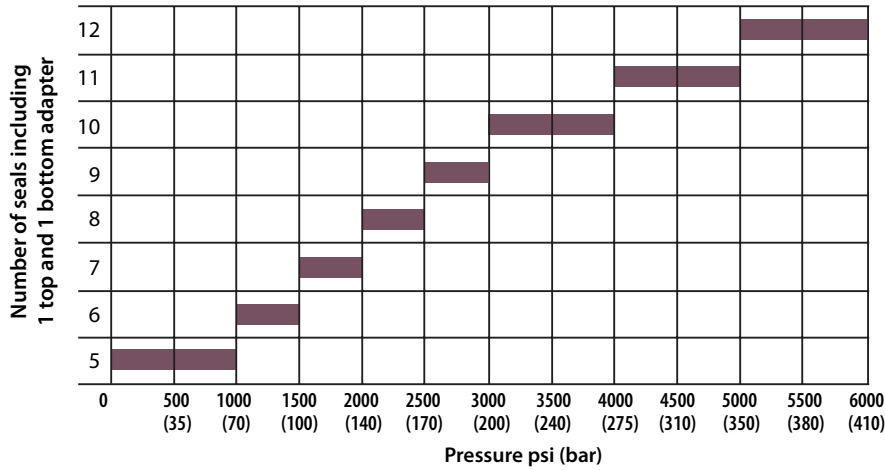

Determine the total number of rings required (including 1 top and 1 bottom adapter ring) based on pressure from Chart 1. For pressure 20 MPa (3000 psi) and above we suggest the use of an anti-extrusion ring. For pressure above 48 MPa (7000 psi), contact EPS Application Engineering. The minimum recommended seal set consists of a 5-ring set: 1 top adapter, 3 seal rings and 1 bottom adapter ring. Determine the approximate free stack height based on cross-section and number of rings of the set from Chart 2 or Chart 3 below.

CHART 2 – R8K STACKED V-RING APPROXIMATE FREE STACK HEIGHT CHART - INCH

Cross Section Inches	R8K STACKED V-RING APPROXIMATE FREE STACK HEIGHT CHART							
Number of Rings	5 Rings	6 Rings	7 Rings	8 Rings	9 Rings	10 Rings	11 Rings	12 Rings
Cross Section mm (inch)	mm (inch)	mm (inch)	mm (inch)	mm (inch)	mm (inch)	mm (inch)	mm (inch)	mm (inch)
3.175 – 5.23 (0.125 – 0.206)	15.57 (0.613)	18.67 (0.735)	21.79 (0.858)	24.82 (0.977)	27.89 (1.098)	30.96 (1.219)	34.04 (1.340)	37.11 (1.461)
5.25 – 6.32 (0.207 – 0.249)	16.84 (0.663)	20.09 (0.791)	23.34 (0.919)	26.59 (1.047)	29.84 (1.175)	33.01 (1.303)	36.35 (1.431)	39.60 (1.559)
6.35 – 7.90 (0.250 – 0.311)	17.20 (0.677)	20.47 (0.806)	23.75 (0.935)	27.02 (1.064)	30.30 (1.193)	33.58 (1.322)	36.86 (1.451)	40.13 (1.580)
7.92 – 9.10 (0.312 – 0.358)	20.32 (0.800)	24.20 (0.953)	28.10 (1.106)	31.98 (1.259)	35.86 (1.412)	39.75 (1.565)	43.64 (1.718)	47.52 (1.871)
9.12 – 10.29 (0.359 – 0.405)	21.23 (0.836)	25.12 (0.989)	29.01 (1.142)	32.89 (1.295)	36.78 (1.448)	40.66 (1.601)	44.55 (1.754)	48.44 (1.907)
10.31 – 12.67 (0.406 – 0.499)	21.90 (0.862)	25.78 (1.015)	29.67 (1.168)	33.55 (1.321)	37.44 (1.474)	41.33 (1.627)	45.21 (1.780)	49.10 (1.933)
12.70 – 15.00 (0.500 – 0.592)	25.15 (0.990)	29.84 (1.175)	34.54 (1.360)	39.24 (1.545)	43.94 (1.730)	48.64 (1.915)	53.34 (2.100)	58.04 (2.285)
15.10 – 16.64 (0.593 – 0.655)	26.52 (1.044)	31.17 (1.227)	35.81 (1.410)	40.46 (1.593)	45.11 (1.776)	49.76 (1.959)	54.41 (2.142)	59.06 (2.325)
16.65 – 19.00 (0.656 – 0.749)	33.68 (1.326)	39.93 (1.572)	46.18 (1.818)	51.97 (2.046)	58.67 (2.310)	64.92 (2.556)	71.17 (2.802)	77.42 (3.048)
19.10 – 22.20 (0.750 – 0.874)	34.57 (1.361)	40.84 (1.608)	47.12 (1.855)	53.39 (2.102)	59.66 (2.349)	65.94 (2.596)	72.21 (2.843)	78.49 (3.090)
22.21 – 24.56 (0.875 – 0.967)	40.90 (1.610)	48.77 (1.920)	56.64 (2.230)	64.52 (2.540)	72.40 (2.850)	80.27 (3.160)	88.14 (3.470)	96.01 (3.780)
24.60 – 28.55 (0.968 – 1.124)	42.16 (1.660)	49.94 (1.966)	57.71 (2.272)	65.48 (2.578)	73.25 (2.884)	81.03 (3.190)	88.80 (3.496)	96.57 (3.802)
28.56 – 36.35 (1.125 – 1.431)	46.20 (1.819)	55.75 (2.195)	65.81 (2.591)	74.85 (2.947)	84.40 (3.323)	93.95 (3.699)	106.05 (4.175)	113.06 (4.451)

The approximate free stack height is calculated from the actual height of the top, bottom and sealer

CHART 3 – R8K STACKED V-RING APPROXIMATE FREE STACK HEIGHT CHART - METRIC

Cross Section mm	R8K STACKED V-RING APPROXIMATE FREE STACK HEIGHT CHART							
Number of Rings	5 Rings	6 Rings	7 Rings	8 Rings	9 Rings	10 Rings	11 Rings	12 Rings
Cross Section mm (inch)	mm (inch)	mm (inch)	mm (inch)	mm (inch)	mm (inch)	mm (inch)	mm (inch)	mm (inch)
5.0 – 7.9 (0.197 – 0.311)	16.70 (0.657)	19.90 (0.78)	23.10 (0.91)	26.30 (1.04)	29.50 (1.16)	32.70 (1.29)	35.90 (1.41)	39.10 (1.54)
8.0 – 10.0 (0.315 – 0.394)	21.06 (0.830)	25.02 (0.99)	28.98 (1.14)	32.94 (1.30)	36.90 (1.45)	40.86 (1.61)	44.82 (1.76)	48.78 (1.92)
10.1 – 12.0 (0.395 – 0.472)	22.14 (0.87)	26.10 (1.03)	30.06 (1.18)	34.02 (1.34)	37.98 (1.50)	41.94 (1.65)	45.90 (1.81)	49.86 (1.96)
12.1 – 14.9 (0.476 – 0.587)	25.00 (0.98)	29.60 (1.17)	35.20 (1.39)	38.8 (1.53)	43.40 (1.71)	48.00 (1.89)	52.60 (2.07)	57.20 (2.25)
15.0 – 17.9 (0.59 – 0.70)	27.73 (1.09)	32.45 (1.28)	37.17 (1.46)	41.89 (1.65)	46.61 (1.84)	51.33 (2.02)	56.05 (2.21)	60.77 (2.39)
18.0 – 22.0 (0.71 – 0.866)	35.94 (1.41)	42.70 (1.68)	49.56 (1.95)	56.42 (2.22)	63.61 (2.50)	70.14 (2.76)	77.00 (3.03)	83.06 (3.27)
22.1 and up (0.87 and up)	42.55 (1.68)	50.45 (1.99)	58.35 (2.30)	66.25 (2.61)	74.15 (2.92)	82.05 (3.23)	89.95 (3.54)	97.85 (3.85)
15.10 – 16.64 (0.593 – 0.655)	26.52 (1.044)	31.17 (1.227)	35.81 (1.410)	40.46 (1.593)	45.11 (1.776)	49.76 (1.959)	54.41 (2.142)	59.06 (2.325)
16.65 – 19.00 (0.656 – 0.749)	33.68 (1.326)	39.93 (1.572)	46.18 (1.818)	51.97 (2.046)	58.67 (2.310)	64.92 (2.556)	71.17 (2.802)	77.42 (3.048)
19.10 – 22.20 (0.750 – 0.874)	34.57 (1.361)	40.84 (1.608)	47.12 (1.855)	53.39 (2.102)	59.66 (2.349)	65.94 (2.596)	72.21 (2.843)	78.49 (3.090)
22.21 – 24.56 (0.875 – 0.967)	40.90 (1.610)	48.77 (1.920)	56.64 (2.230)	64.52 (2.540)	72.40 (2.850)	80.27 (3.160)	88.14 (3.470)	96.01 (3.780)
24.60 – 28.55 (0.968 – 1.124)	42.16 (1.660)	49.94 (1.966)	57.71 (2.272)	65.48 (2.578)	73.25 (2.884)	81.03 (3.190)	88.80 (3.496)	96.57 (3.802)
28.56 – 36.35 (1.125 – 1.431)	46.20 (1.819)	55.75 (2.195)	65.81 (2.591)	74.85 (2.947)	84.40 (3.323)	93.95 (3.699)	106.05 (4.175)	113.06 (4.451)

The approximate free stack height is calculated from the actual height of the top, bottom and sealer

R27K Rod Seals

Pressure-sensitive, Stacked Set for Hydraulic Sealing

The Chesterton R27K is a single-acting, stacked V-Ring set with a positive rake design to provide optimum operating performance in heavy-duty hydraulic rod applications. Unlike conventional stacked sets, these designs make contact through the center to enable even loading which minimizes friction and provides longer sealing life.

The minimal gland pressure enables these sets to withstand greater sliding speed than conventional stacked sets. No readjustment of the seal precompression is needed after installation. Flared, pressure-sensitive lip design provides optimum sealing forces on seal rings, which are reactive to pressure thus reducing breakaway and frictional force.

The set is available in various material combinations to accommodate new or used equipment and can be supplied in split or solid designs.

The R27K is manufactured using a machining process which allows the flexibility to create any size based on equipment dimensions and eliminates tooling cost for new sizes. Each set incorporates a male and female adapter to align and support the seal rings.

Additional profiles have been derived from the original R27K design to address specific needs and applications in the market. These include designs for excessive clearances and deep stuffing boxes.

SPECIFICATIONS



Material (designation)	Size Range* mm (inch)	Temperature °C (°F)	Pressure MPa (psi)	Speed m/s (ft/min)
AWC704 (FKM)	6 – 304.8 (1/4 – 12)	-30 – 200 (-20 – 400)	16 (2320)	1.5 (300)
AWC800 (EU)	6 – 1320 (1/4 – 52)	-50 – 85 (-60 – 185)	103.5 (15000)	1 (200)
AWC808 (AU)	6 – 400 (1/4 – 15.75)	-20 – 85 (-4 – 185)	40 (5800)	0.5 (100)
AWC825 (EU)	6 – 1320 (1/4 – 52)	-40 – 85 (-40 – 185)	52 (7500)	0.5 (100)
AWC830 (EU)	6 – 254 (1/4 – 10)	-35 – 75 (-30 – 175)	52 (7500)	0.9 (185)
AWC860 (EU)	6 – 508.0 (1/4 – 20)	-50 – 120 (-60 – 250)	103.5 (15000)	1.25 (250)

*Please contact your Chesterton representative for larger sizes.

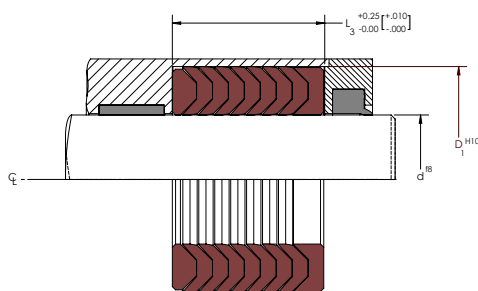

PRODUCT PROFILES



R27K

R27K1



- Minimal gland pressure offers greater speed capability than conventional sets
- Even stack load design minimizes friction and extends service life
- Flared, pressure-sensitive lip; sealing forces are reactive to pressure
- Material combinations designed for use in both new and worn equipment
- Delivered as split components for ease of installation

CHART 1 – R27K FLUID PRESSURE - SEAL RING CHART

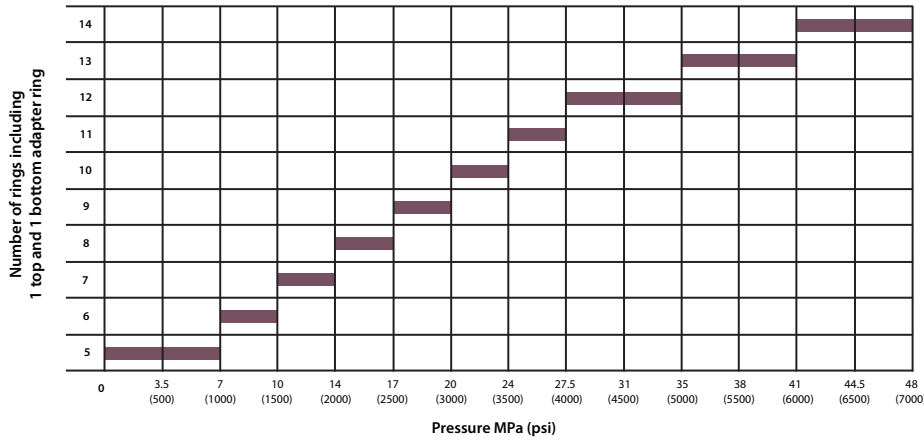

Determine the total number of rings required (including 1 top and 1 bottom adapter ring) based on pressure from Chart 1. For pressure 20 MPa (3000 psi) and above we suggest the use of an anti-extrusion ring. For pressure above 48 MPa (7000 psi), contact EPS Application Engineering. The minimum recommended seal set consists of a 5-ring set: 1 top adapter, 3 seal rings and 1 bottom adapter ring. Determine the approximate free stack height based on cross section and number of rings of the set from Chart 2 below.

CHART 2 – R27K V-RING APPROXIMATE FREE STACK HEIGHT CHART

Number of Rings	5 Rings	6 Rings	7 Rings	8 Rings	9 Rings	10 Rings	11 Rings	12 Rings	13 Rings	14 Rings
Pressure Rating MPa (psi)	7 (1000)	10 (1500)	14 (2000)	17 (2500)	20 (3000)	24 (3500)	27.5 (4000)	35 (5000)	41 (6000)	48 (7000)
CROSS SECTION mm (inch)	mm (inch)	mm (inch)	mm (inch)	mm (inch)	mm (inch)	mm (inch)	mm (inch)	mm (inch)	mm (inch)	mm (inch)
3.172 ≤ S < 4.773 (0.1249 ≤ S < 0.1879)	12.04 (0.474)	13.94 (0.549)	15.85 (0.624)	17.75 (0.699)	19.66 (0.774)	21.56 (0.849)	23.47 (0.924)	25.40 (1.000)	27.28 (1.074)	29.18 (1.149)
4.773 ≤ S < 6.348 (0.1879 ≤ S < 0.2499)	16.10 (0.634)	19.18 (0.755)	22.25 (0.876)	25.32 (0.997)	28.40 (1.118)	31.47 (1.239)	34.54 (1.360)	37.62 (1.481)	40.69 (1.602)	43.76 (1.723)
6.348 ≤ S < 7.948 (0.2499 ≤ S < 0.3129)	16.83 (0.66)	19.99 (0.787)	23.22 (0.914)	26.44 (1.041)	29.67 (1.168)	32.69 (1.287)	36.12 (1.422)	39.34 (1.549)	42.57 (1.676)	45.80 (1.803)
7.948 ≤ S < 9.523 (0.3129 ≤ S < 0.3749)	20.55 (0.809)	24.51 (0.965)	28.47 (1.121)	32.44 (1.277)	36.40 (1.433)	40.36 (1.589)	44.32 (1.745)	48.29 (1.901)	52.25 (2.057)	56.21 (2.213)
9.523 ≤ S < 11.123 (0.3749 ≤ S < 0.4379)	21.49 (0.846)	25.5 (1.004)	29.51 (1.162)	33.53 (1.320)	37.54 (1.478)	41.55 (1.636)	45.57 (1.794)	49.58 (1.952)	53.59 (2.110)	57.60 (2.268)
11.123 ≤ S < 12.698 (0.4379 ≤ S < 0.4999)	22.50 (0.886)	26.57 (1.046)	30.63 (1.206)	34.70 (1.366)	38.76 (1.526)	42.82 (1.686)	46.89 (1.846)	50.95 (2.006)	55.02 (2.166)	59.08 (2.326)
12.698 ≤ S < 14.298 (0.4999 ≤ S < 0.5629)	25.30 (0.996)	29.97 (1.180)	34.65 (1.364)	39.32 (1.548)	43.99 (1.732)	48.67 (1.916)	53.34 (2.100)	58.01 (2.284)	62.69 (2.468)	67.36 (2.652)
14.298 ≤ S < 15.873 (0.5629 ≤ S < 0.6249)	26.42 (1.040)	31.12 (1.225)	35.81 (1.410)	40.51 (1.595)	45.21 (1.780)	49.91 (1.965)	54.61 (2.150)	59.31 (2.335)	64.01 (2.520)	68.71 (2.705)
15.873 ≤ S < 17.473 (0.6249 ≤ S < 0.6879)	28.50 (1.122)	33.81 (1.331)	39.12 (1.540)	44.42 (1.749)	49.73 (1.958)	55.04 (2.167)	60.35 (2.376)	65.666 (2.585)	70.97 (2.794)	76.28 (3.003)
17.473 ≤ S < 19.048 (0.6879 ≤ S < 0.7499)	33.76 (1.329)	40.03 (1.576)	46.3 (1.823)	52.58 (2.070)	58.85 (2.317)	65.13 (2.564)	71.40 (2.811)	77.67 (3.058)	83.95 (3.305)	90.22 (3.552)
19.048 ≤ S < 22.223 (0.7499 ≤ S < 0.8749)	34.49 (1.358)	40.77 (1.605)	47.04 (1.852)	53.31 (2.099)	59.59 (2.346)	65.86 (2.593)	72.14 (2.840)	78.41 (3.087)	84.69 (3.334)	90.96 (3.581)
22.223 ≤ S < 23.823 (0.8749 ≤ S < 0.9379)	40.77 (1.605)	48.54 (1.911)	56.31 (2.217)	64.08 (2.523)	71.86 (2.829)	79.63 (3.135)	87.40 (3.441)	95.17 (3.747)	102.95 (4.053)	110.72 (4.359)
23.823 ≤ S < 25.398 (0.9379 ≤ S < 0.9999)	40.77 (1.605)	48.54 (1.911)	56.31 (2.217)	64.08 (2.523)	71.86 (2.829)	79.63 (3.135)	87.40 (3.441)	95.17 (3.747)	102.95 (4.053)	110.72 (4.359)
25.398 ≤ S < 26.998 (0.9999 ≤ S < 1.0629)	43.69 (1.720)	51.64 (2.033)	59.59 (2.346)	67.54 (2.659)	75.49 (2.972)	83.44 (3.285)	91.39 (3.598)	99.34 (3.911)	107.29 (4.224)	115.24 (4.537)
26.998 ≤ S < 30.173 (1.0629 ≤ S < 1.1879)	44.704 (1.760)	52.73 (2.075)	60.76 (2.392)	68.78 (2.708)	76.81 (3.024)	84.84 (3.340)	92.86 (3.656)	100.89 (3.972)	108.92 (4.288)	116.94 (4.604)
30.173 ≤ S < 31.748 (1.1879 ≤ S < 1.2499)	52.10 (2.051)	61.8 (2.433)	71.5 (2.815)	81.20 (3.197)	90.91 (3.579)	100.61 (3.961)	110.31 (4.343)	120.02 (4.725)	129.72 (5.107)	139.42 (5.489)
31.748 ≤ S < 33.348 (1.2499 ≤ S < 1.3129)	52.91 (2.083)	62.61 (2.465)	72.31 (2.847)	82.02 (3.229)	91.72 (3.611)	101.42 (3.993)	111.13 (4.375)	120.83 (4.757)	130.53 (5.139)	140.23 (5.521)

R28K Rod Seals

Robust Stacked Set for Heavy-Duty Hydraulic Sealing

The Chesterton R28K is a single-acting stacked V-Ring sets for high performance sealing in heavy-duty hydraulic rod and ram applications. The robust, multi-lip design provides conformal sealing that improves hydraulic equipment efficiency and reliability even in the most hostile operating conditions.

R28K sets comprise female and male gland adapters (for supporting and energizing functions) and three to five sealing rings, depending on operating conditions and equipment hardware configuration. The gland pressure (energizing axial force) is transferred between the seal rings, pressurizing them and creating optimal, positive contact to the counter surfaces. Ductile lip design helps to reduce sealing forces on seal rings, improving their ability to be reactive to pressure and reducing breakaway and frictional force.

Flexible and simplified design ensures the easy configuration of seal sets for retrofit applications. The set is available in various material combinations to accommodate new or used equipment and can be supplied in split or solid designs.

The R28K is manufactured using a machining process which allows the flexibility to create any size based on equipment dimensions and eliminates tooling costs for new sizes. Additional profiles have been derived from the original R28K design to address specific needs and applications in the market. These include designs for excessive clearances and deep stuffing boxes.

SPECIFICATIONS



Material (designation)	Size Range* mm (inch)	Temperature °C (°F)	Pressure MPa (psi)	Speed m/s (ft/min)
AWC704 (FKM)	6 – 304.8 (1/4 – 12)	-30 – 200 (-20 – 400)	16 (2320)	1.5 (300)
AWC800 (EU)	6 – 1320 (1/4 – 52)	-50 – 85 (-60 – 185)	103.5 (15000)	1 (200)
AWC808 (AU)	6 – 400 (1/4 – 15.75)	-20 – 85 (-4 – 185)	40 (5800)	0.5 (100)
AWC825 (EU)	6 – 1320 (1/4 – 52)	-40 – 85 (-40 – 185)	52 (7500)	0.5 (100)
AWC830 (EU)	6 – 254 (1/4 – 10)	-35 – 75 (-30 – 175)	52 (7500)	0.9 (185)
AWC860 (EU)	6 – 508.0 (1/4 – 20)	-50-120 (-60 – 250)	103.5 (15000)	1.25 (250)

*Please contact your Chesterton representative for larger sizes.

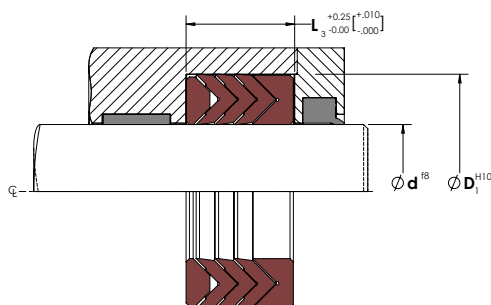

PRODUCT PROFILES

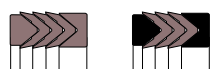

R28K

R28K1

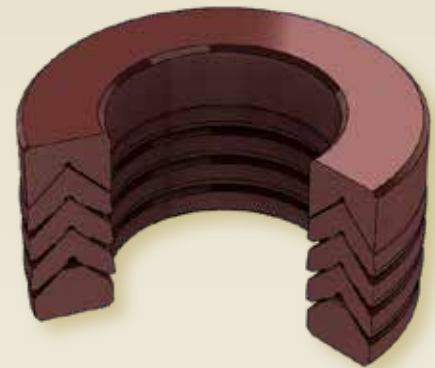

- Ease of configuration for retrofit applications
- Flexible seal system for most heavy-duty hydraulic applications
- Ductile lip design for reduced sealing force and wear
- Material combinations for use in both new and worn equipment
- R28K design can be delivered as split for ease of installation

R20K Rod Seals

Heavy-duty Bidirectional, Low-Speed Hydraulic Sealing

Chesterton R20K is a continuous, bidirectional compression seal with dual independent sealing points for hydraulic rod applications. The robust, durable, dual-lip profile is used for single-groove cavities in heavy-duty, high-pressure, hydraulic applications.

The entire seal cross section of the seal is preloaded by the seal groove when installed to ensure tight sealing even at low pressure thus preventing fluid bypass from start-up. When the system pressure increases, the hydraulic fluid energizes the seal, increasing the sealing area and sealing efficiency of the component.

The heavy-duty seal design with incorporated anti-extrusion ring helps R20K to withstand transverse loads and extreme pressure conditions, just like pressure peaks and shock load during operation and it further increases extrusion resistance of the seal component at larger clearances.

20K is an ideal solution for static and dynamic applications even in the most demanding applications.

The R20K Duo seals are made from our unique machining process which eliminates the need for tooling costs associated with new sizes.

Additional designs were developed to meet specific application and equipment needs including the incorporation of various anti-extrusion devices for combating excessive clearances and pressure spikes.



- Reduces risk of fluid bypass from start-up of the hydraulic system
- Ideal replacement for 2-, 3-, or 4-piece cap seal and compression seal assemblies
- Superior extrusion, transverse load, and wear resistance
- Ideal solution for static and dynamic applications
- Unique manufacturing process allows the flexibility to create any size

SPECIFICATIONS



Material (designation)	Size Range* mm (inch)	Temperature °C (°F)	Pressure MPa (psi)	Speed m/s (ft/min)
AWC704 (FKM)	6 – 304.8 (1/4 – 12)	-30 – 200 (-20 – 400)	16 (2320)	1.5 (300)
AWC800 (EU)	6 – 2540 (1/4 – 100)	-50 – 85 (-60 – 185)	103.5 (15000)	1 (200)
AWC808 (AU)	6 – 400 (1/4 – 15.75)	-20 – 85 (-4 – 185)	40 (5800)	0.5 (100)
AWC825 (EU)	6 – 2540 (1/4 – 100)	-40 – 85 (-40 – 185)	52 (7500)	0.5 (100)
AWC830 (EU)	6 – 254 (1/4 – 10)	-35 – 75 (-30 – 175)	52 (7500)	0.9 (185)
AWC860 (EU)	6 – 508.0 (1/4 – 20)	-50 – 120 (-60 – 250)	103.5 (15000)	1.25 (250)

*Please contact your Chesterton representative for larger sizes.

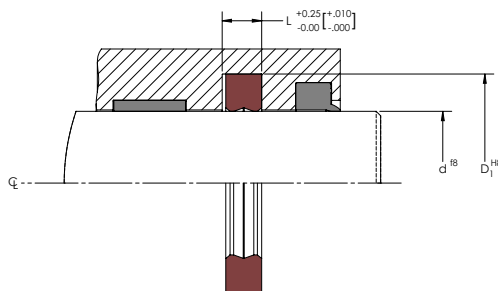

PRODUCT PROFILES



R20K1



R20K2



R20K3



R20KDAER

RCCS Rod Seals

Dual-component Cap Seals for Hydraulic and Pneumatic Sealing

Chesterton Rod Custom Cap Seals (RCCS) are custom-manufactured, dual-component seals for rod applications. This cap seal design is comprised of a two-piece, sealing system that uses a rubber energizer and high performance plastic cap, creating very effective sealing and providing long service life. RCCS meets demanding operating conditions, where high sliding speed, elevated operating temperature, or hydraulic media compatibility challenges the seals or low friction is required. RCCS is an ideal sealing solution for a broad range of hydraulic and pneumatic applications.

The cap is used as the dynamic sealing element while the O-Ring energizes the cap and creates a static seal. The rubber energizer provides flexibility and support to the cap ring to compensate for radial movements. The cap ring is preloaded with adequate contact surface to retain hydraulic media at zero or low pressure. Higher system pressure actuates the rubber energizer which compresses the cap ring more against the rod, increasing sealing surface and sealing efficiency.

Special plastic compounds of the cap rings have low frictional characteristics. The most common materials are second generation PTFE compounds and high performance thermoset polyurethanes. Such materials provide low breakaway and frictional force, so stick-slip effect can be reduced.

For the best possible performance it is recommended to use RCCS seals in tandem rod seal configurations or utilize RCCS as the primary seal in the buffer seal position thus protecting the secondary seal.

Each cap seal is made using our machining process which eliminates the need for tooling costs associated with new sizes.

Additional designs were developed to meet specific application and equipment needs. Both components are available in a range of engineered materials to best suit the specific operating requirements.



- Second-generation PTFE compounds and high performance polyurethanes offers improved performance
- Compression seal design increases sealing force with system pressure
- Proven seal design provides predictable performance
- Low breakaway and friction for smooth movement and elimination of stick-slip
- High performance solutions for most demanding hydraulic and pneumatic applications

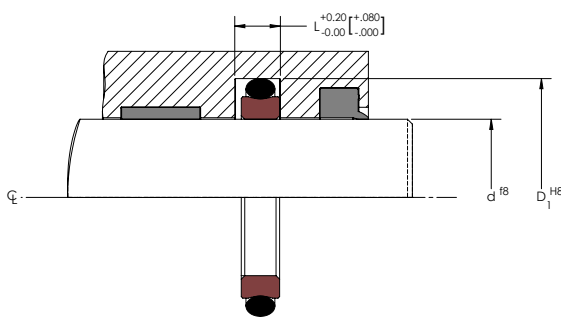

PRODUCT PROFILES



RCCS



RCCS1



RCCS2



RCCS3



RCCS4



SPECIFICATIONS

Material (designation)	Size Range* mm (inch)	Temperature °C (°F)	Speed m/s(ft/min) Reciprocating
**AWC800 (EU)	6 – 1320 (1/4 – 52)	-50 – 85 (-60 – 185)	1(200)
**AWC808 (AU)	6 – 400 (1/4 – 15.75)	-20 – 85 (-4 – 185)	0.5(100)
**AWC830 (EU)	6 – 254 (1/4 – 10)	-35 – 75 (-30 – 175)	0.9(185)
**AWC860 (EU)	6 – 508.0 (1/4 – 20)	-50 – 120 (-60 – 250)	1.25(250)
***AWC300 (Glass-Filled PTFE)	up to 600 (24)	-35 – 120 (-30 – 250)	15(3000)
***AWC400 (Carbon-Filled PTFE)	up to 600 (24)	-35 – 120 (-30 – 250)	15(3000)
***AWC500 (Bronze-Filled PTFE)	up to 600 (24)	-35 – 120 (-30 – 250)	15(3000)
***AWC520 (Virgin PTFE)	up to 600 (24)	-35 – 120 (-30 – 250)	15(3000)

*Please contact your Chesterton representative for larger sizes

**O-Ring material is NBR

***O-Ring material is FKM

Applicable standard: ISO 4725-2

RECOMMENDED GROOVE DIMENSIONS - METRIC

Rod Diameter Range mm			Rod Seal Groove Diameter	Seal Groove Height	Seal Cross Section	Radius	Diametrical Clearance (mm)		O-Ring Cross Section
Heavy-Duty	Medium-Duty	Light-Duty	D ₁ H8	L (+200/-0) (mm)	C/S (mm)	R (mm)	0 – 20 MPa	20 – 40 MPa	OR (mm)
–	3.0 – 7.90	8.0 – 18.90	d + 4.9	2.2	2.45	0.40	0.40	0.30	1.78
–	8.0 – 18.90	19.0 – 37.90	d + 7.3	3.2	3.65	0.60	0.50	0.30	2.62
8.0 – 18.90	19.0 – 37.90	38.0 – 199.9	d + 10.7	4.2	5.35	0.80	0.50	0.40	3.53
19.0 – 37.90	38.0 – 199.9	200.0 – 255.90	d + 15.1	6.3	7.55	1.00	0.60	0.40	5.33
38.0 – 199.9	200.0 – 255.90	256.0 – 649.90	d + 20.5	8.1	10.25	1.50	0.60	0.50	6.99
200.0 – 255.90	256.0 – 649.90	650.0 – 999.90	d + 24	8.1	12	1.50	1.00	0.60	6.99
256.0 – 649.90	650.0 – 999.90	–	d + 27.3	9.5	13.65	2.00	1.00	0.70	8.40
650.0 – 999.90	1,000 +	–	d + 27.3	9.5	13.65	2.50	1.2	1.00	8.40

RECOMMENDED GROOVE DIMENSIONS - INCH

Rod Diameter Range inch			Rod Seal Groove Diameter	Seal Groove Height	Seal Cross Section	Radius	Diametrical Clearance (inch)		O-Ring Cross Section
Heavy-Duty	Medium-Duty	Light-Duty	D ₁ H8	L (+.008/-0) (inch)	C/S (inch)	R (inch)	0 – 3000 psi	3000 – 6000 psi	OR (inch)
–	0.118	0.311	d + .193	0.087	0.096	0.016	0.016	0.012	0.070
–	0.315	0.744	d + .287	0.126	0.144	0.024	0.020	0.012	0.103
0.315	0.748	1.492	d + .421	0.165	0.211	0.031	0.020	0.016	0.139
0.748	1.496	7.870	d + .594	0.248	0.297	0.039	0.024	0.016	0.210
1.496	7.874	10.075	d + .807	0.319	0.404	0.059	0.024	0.020	0.275
7.874	10.079	25.587	d + .945	0.319	0.472	0.059	0.039	0.024	0.275
10.079	25.590	39.366	d + 1.075	0.374	0.537	0.079	0.039	0.028	0.331
25.590	39.370 +	–	d + 1.075	0.374	0.537	0.098	0.047	0.039	0.331

P22K Piston Seals

Special Geometry Provides Optimal Sealing Performance

The Chesterton P22K is a single-acting, asymmetric, continuous U-Cup design. A unique seal lip geometry in combination with twin lip arrangement on dynamic the side provides zero leakage throughout the entire operating range, resulting in tight, bypass-free operation. The sturdy, static lip stabilizes the seal against possible rolling while the dynamic lip design minimizes potential issues associated with low-pressure sealing, provides additional stability, and eases installation.

The optimum seal design enables controlled pressure distribution through the entire seal component while the proper expansion space provides free space for deformation under pressure, optimizing seal contact area on the sliding surface.

INSTALLED

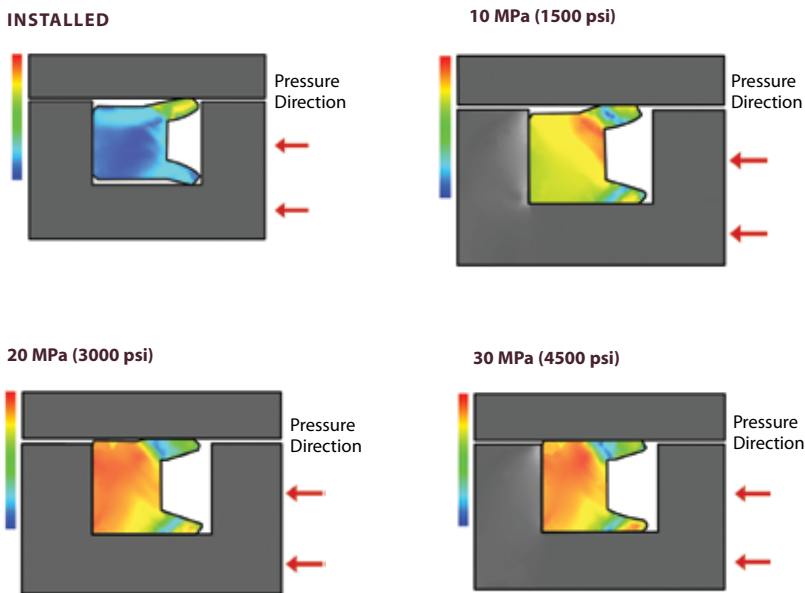

This seal design is offered as a piston seal and provides excellent performance in light- to heavy-duty hydraulic applications. Robust seal construction makes P22K insensitive to pressure fluctuation and, in combination with high performance polyurethane materials, the seal has outstanding pressure/shock load capability.

The P22K design is manufactured using a machining process which allows the flexibility to create any size based on equipment dimensions.

A number of additional designs have been derived from the original P22K design to address specific needs and applications in the market. These include the use of anti-extrusion rings for use in equipment with excessive clearances.



- Single-acting, U-Cup design; zero leakage throughout the entire operating range
- Abrasion-resistant design; excellent performance in hydraulic applications
- Insensitive to pressure fluctuation and excellent pressure/shock load capability
- Machining process allows the flexibility to create any size
- Sizes made to accommodate international standards including ISO

SPECIFICATIONS



Material (designation)	Size Range* mm (inch)	Temperature °C (°F)	Pressure MPa (psi)	Speed m/s (ft/min)
AWC704 (FKM)	6 – 304.8 (1/4 – 12)	-30 – 200 (-20 – 400)	16 (2320)	1.5 (300)
AWC800 (EU)	6 – 1320 (1/4 – 52)	-50 – 85 (-60 – 185)	103.5 (15000)	1 (200)
AWC808 (AU)	6 – 400 (1/4 – 15.75)	-20 – 85 (-4 – 185)	40 (5800)	0.5 (100)
AWC825 (EU)	6 – 1320 (1/4 – 52)	-40 – 85 (-40 – 185)	52 (7500)	0.5 (100)
AWC830 (EU)	6 – 254 (1/4 – 10)	-35 – 75 (-30 – 175)	52 (7500)	0.9 (185)
AWC860 (EU)	6 – 508.0 (1/4 – 20)	-50 – 120 (-60 – 250)	103.5 (15000)	1.25 (250)

*Please contact your Chesterton representative for larger sizes.

Applicable standard: ISO 5597

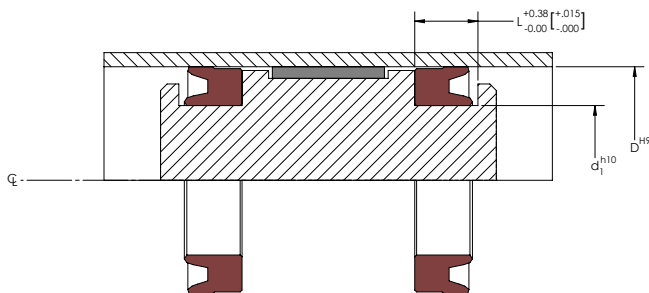

PRODUCT PROFILES



P22K

P22KAER

P22KAER1

P22KN Piston Seals

Low Friction Design for Hydraulic and Pneumatic Sealing

Chesterton P22KN are single-acting, continuous U-Cup designs. The special lip design provides an optimal amount of radial sealing load with excellent tribological and sealing characteristics which result in minimal frictional resistance and low heat generation. Utilization of P22KN U-Cup assists in reducing breakaway force and dynamic frictional force during operation.

The optimum seal design enables controlled pressure distribution through the entire seal component, while the proper expansion space provides free space for deformation under pressure thus optimizing seal contact area on the sliding surface.

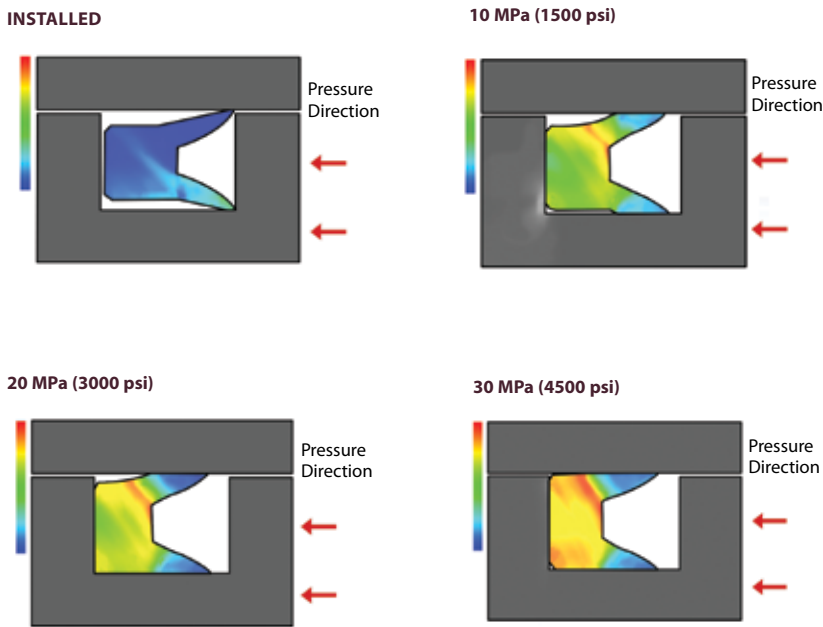

The positive rake, lip profile wipes contaminants away from the mating surface while in operation thus prolonging seal and equipment service life. This seal design is offered as a piston seal and provides outstanding performance in light- to heavy-duty hydraulic and pneumatic applications.

The optimum seal design enables controlled pressure distribution through the entire seal component, while the proper expansion space provides free space for deformation under pressure thus optimizing seal contact area on the sliding surface.

The P22KN design is manufactured using a machining process which allows the flexibility to create any size based on equipment dimensions.

A number of unique designs have been derived from the original P22KN to address specific needs and applications in the market. These include designs to address pressure reversal, pressure spikes, and system vacuuming.



- Single-acting, U-Cup design minimizes frictional resistance and breakaway force
- Positive rake lip design wipes contaminants away from mating surface
- Abrasion-resistant design; outstanding performance in hydraulic and pneumatic applications
- Manufacturing process allows flexibility to create any size
- Sizes made to accommodate international standards including ISO



SPECIFICATIONS

Material (designation)	Size Range* mm (inch)	Temperature °C (°F)	Pressure MPa (psi)	Speed m/s (ft/min)
AWC704 (FKM)	6 – 304.8 (1/4 – 12)	-30 – 200 (-20 – 400)	16 (2320)	1.5 (300)
AWC800 (EU)	6 – 2540 (1/4 – 100)	-50 – 85 (-60 – 185)	103.5 (15000)	1 (200)
AWC808 (AU)	6 – 400 (1/4 – 15.75)	-20 – 85 (-4 – 185)	40 (5800)	0.5 (100)
AWC825 (EU)	6 – 2540 (1/4 – 100)	-40 – 85 (-40 – 185)	52 (7500)	0.5 (100)
AWC830 (EU)	6 – 254 (1/4 – 10)	-35 – 75 (-30 – 175)	52 (7500)	0.9 (185)
AWC860 (EU)	6 – 508.0 (1/4 – 20)	-50–120 (-60 – 250)	103.5 (15000)	1.25 (250)

*Please contact your Chesterton representative for larger sizes.

Applicable standard: ISO 5597

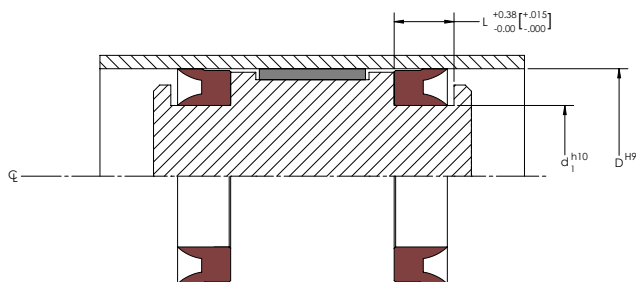

PRODUCT PROFILES

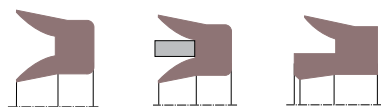

P22KN

P22KN1

P22KN5

P22KE Piston Seals

Energized Dual-component for Added Stability

The Chesterton P22KE is a single-acting, continuous U-Cup design which incorporates the use of an O-Ring to increase preload capabilities. The O-Ring energizes the seal in the absence of system pressure, helps to increase sealing force, and provides stability at higher temperature conditions. System pressure rise will increase sealing force thus completely actuating the lips through the O-Ring.

The excellent resistance to abrasion and trimmed seal lips provides outstanding performance in medium- to heavy-duty hydraulic applications. The rubber energizer cushions the seal against shock load and pressure peaks. Incorporated anti-extrusion ring helps the seal to withstand transverse loads and extreme pressure conditions during operation and it further increases extrusion resistance of the seal component at larger clearances. This seal design is offered as a piston seal.

The P22KE design is manufactured using a machining process which allows the flexibility to create any size based on equipment dimensions.



- Single-acting U-Cup design; minimizing risk of leakage throughout the operating range
- O-Ring loader energizes seal and provides stability at higher pressures
- Abrasion-resistant design; excellent performance in hydraulic applications
- High resistance against transverse load, pressure peaks, and extrusion
- Machining process allows the flexibility to create any size

SPECIFICATIONS



Material (designation)	Size Range* mm (inch)	Temperature °C (°F)	Pressure MPa (psi)	Speed m/s (ft/min)
AWC704 (FKM)	6 – 304.8 (1/4 – 12)	-30 – 200 (-20 – 400)	16 (2320)	1.5 (300)
AWC800 (EU)	6 – 1320 (1/4 – 52)	-50 – 85 (-60 – 185)	103.5 (15000)	1 (200)
AWC808 (AU)	6 – 400 (1/4 – 15.75)	-20 – 85 (-4 – 185)	40 (5800)	0.5 (100)
AWC825 (EU)	6 – 1320 (1/4 – 52)	-40 – 85 (-40 – 185)	52 (7500)	0.5 (100)
AWC830 (EU)	6 – 254 (1/4 – 10)	-35 – 75 (-30 – 175)	52 (7500)	0.9 (185)
AWC860 (EU)	6 – 508.0 (1/4 – 20)	-50 – 120 (-60 – 250)	103.5 (15000)	1.25 (250)

*Please contact your Chesterton representative for larger sizes.
Applicable standard: ISO 5597

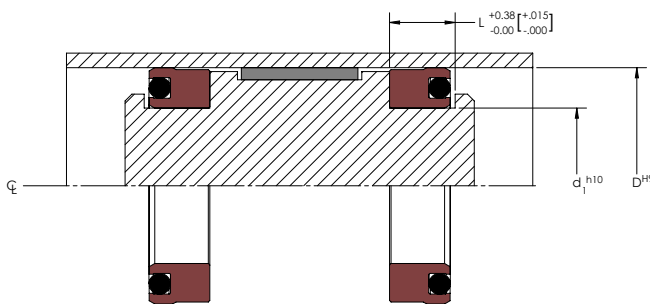

PRODUCT PROFILES



P22KE P22KEAER P22KEAER1

P7K Piston Seals

Piston Cup with Rigid Base for Hydraulic and Pneumatic Sealing

Chesterton 7K is a single-acting piston cup with a positive, flared lip design to optimize dynamic sealing forces. Reduced frictional force and low heat generation result in low wear thus prolonging seal and cylinder service life and reliability. The seal is responsive to low pressure fluctuation thus optimizing sealing effect in most operating conditions. The rugged construction is the ideal replacement to upgrade from traditional rubber-based construction for use in light- to medium-duty hydraulic or pneumatic applications.

High performance thermoset polyurethane materials provide superior wear resistance and excellent memory retaining lip flare.

The 7K is manufactured from a custom compression molding process with a supporting brass disc molded into the base. The resulting rigid base provides a stable, non-distorting, anti-extrusion resistant seal while the center hole can be custom sized to meet your equipment-specific needs.

The 7K1 is polyurethane throughout and is manufactured using a machining process that allows the flexibility to create any size based on equipment dimensions.

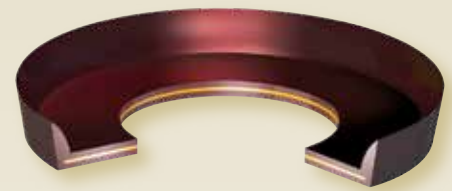

- Positive flared lip design optimizes sealing forces
- Supporting metallic brass disc improves seal performance
- Long-life cup resists swelling, deformation, drag, and binding
- Custom sized center hole makes seal retrofit

SPECIFICATIONS



Material (designation)	Size Range mm (inch)	Temperature °C (°F)	Pressure MPa (psi)	Speed m/s(ft/min) Reciprocating/ Rotary
AWC704 (FKM)	6 – 304.8 (1/4 – 12)	-30 – 200 (-20 – 400)	16 (2300)	1.5 (300)
AWC800 (EU)	6 – 1320 (1/4 – 52)	-50 – 85 (-60 – 185)	16 (2300)	1 (200)
AWC805 (EU)	25 – 711 (1 – 28)	-50 – 85 (-60 – 185)	16 (2300)	0.5 (100)
AWC808 (AU)	6 – 400 (1/4 – 15.75)	-20 – 85 (-4 – 185)	16 (2300)	0.5 (100)
AWC825 (EU)	6 – 1320 (1/4 – 52)	-40 – 85 (-40 – 185)	16 (2300)	0.5 (100)
AWC830 (EU)	6 – 254 (1/4 – 10)	-35 – 75 (-30 – 175)	16 (2300)	0.9 (185)
AWC860 (EU)	6 – 508.0 (1/4 – 20)	-50 – 120 (-60 – 250)	16 (2300)	1.25 (250)

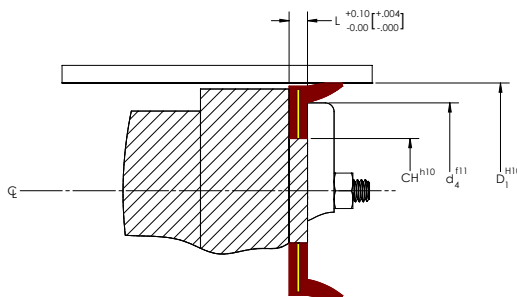

PRODUCT PROFILES



P7K



P7K1

P23K Piston Seals

Optimum Geometry for Pneumatic Sealing

The Chesterton P23K seal is a single-acting, U-Cup design that incorporates a unique, dynamic lip geometry that provides the optimal sealing force required for low-pressure pneumatic piston applications. Radiused lip and lower lip preload produces a continuous lubrication film which minimizes frictional force, heat generation, and wear. This unique sealing characteristic helps to reduce breakaway and frictional force during operation which significantly improves seal and equipment service life and reliability. Increased lip groove of the u-profile improves seal flexibility.

The use of high performance, wear-resistant, thermoset polyurethanes instead of rubber compounds will help to reduce wear and increase seal life even in improperly lubricated air.

The P23K design is manufactured using a machining process which allows the flexibility to create any size based on equipment dimensions.



- Unique lip geometry provides optimal sealing force for pneumatic applications
- Radiused lip and lower preload design produces continuous lubricating film, minimizing wear
- Reduced breakaway and frictional force
- Machining process allows the flexibility to create any size
- Sizes made to accommodate international standards including ISO

SPECIFICATIONS



Material (designation)	Size Range* mm (inch)	Temperature °C (°F)	Pressure MPa (psi)	Speed m/s (ft/min)
AWC704 (FKM)	6 – 304.8 (1/4 – 12)	-30 – 200 (-20 – 400)	9 (125)	1.5 (300)
AWC800 (EU)	6 – 2540 (1/4 – 100)	-50 – 85 (-60 – 185)	9 (125)	1 (200)
AWC808 (AU)	6 – 400 (1/4 – 15.75)	-20 – 85 (-4 – 185)	9 (125)	0.5 (100)
AWC825 (EU)	6 – 2540 (1/4 – 100)	-40 – 85 (-40 – 185)	9 (125)	0.5 (100)
AWC830 (EU)	6 – 254 (1/4 – 10)	-35 – 75 (-30 – 175)	9 (125)	0.9 (185)
AWC860 (EU)	6 – 508.0 (1/4 – 20)	-50 – 120 (-60 – 250)	9 (125)	1.25 (250)

*Please contact your Chesterton representative for larger sizes.
Applicable standard: ISO 5597

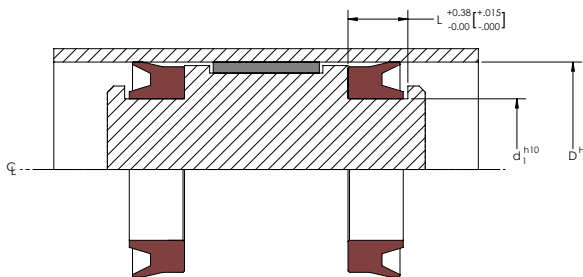

PRODUCT PROFILES



P23K

P28K Piston Seals

Robust, Stacked Set for Heavy-duty Hydraulic Sealing

The Chesterton P28K is a single-acting, stacked V-Ring set designed for high performance sealing in heavy-duty hydraulic piston applications. The robust, multi-lip design provides conformal sealing that improves hydraulic equipment efficiency and reliability even in the most hostile operating conditions.

P28K sets comprise female and male gland adapters (for supporting and energizing functions) and three to five sealing rings, depending on operating conditions and equipment hardware configuration. The seal cavity pressure (energizing axial force) is transferred between the seal rings, pressurizing them and creating optimal, positive contact to the counter surfaces. Ductile lip design helps to reduce sealing forces on seal rings to improve the ability to be reactive to pressure and to reduce breakaway and frictional force.

Flexible and simplified design ensures the easy configuration of seal sets for retrofit applications. The set is available in various material combinations to accommodate new or used equipment and can be supplied in solid designs.

The P28K is manufactured using a machining process which allows the flexibility to create any size based on equipment dimensions and eliminates tooling cost for new sizes. Additional profiles have been derived from the original P28K design to address specific needs and applications in the market. These include designs for excessive clearances and deep stuffing boxes.

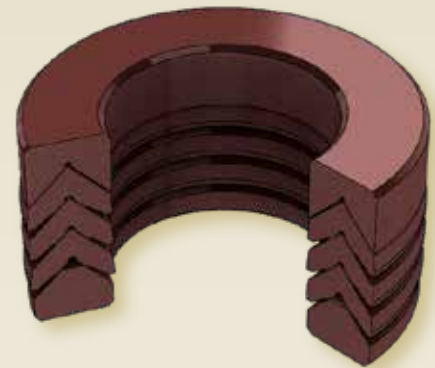

- Ease of configuration for retrofit applications
- Flexible seal system for most heavy-duty hydraulic applications
- Ductile lip design for reduced sealing force and wear
- Material combinations for use in both new and worn equipment

SPECIFICATIONS



Material (designation)	Size Range* mm (inch)	Temperature °C (°F)	Pressure MPa (psi)	Speed m/s (ft/min)
AWC704 (FKM)	6 – 304.8 (1/4 – 12)	-30 – 200 (-20 – 400)	16 (2320)	1.5 (300)
AWC800 (EU)	6 – 1320 (1/4 – 52)	-50 – 85 (-60 – 185)	103.5 (15000)	1 (200)
AWC808 (AU)	6 – 400 (1/4 – 15.75)	-20 – 85 (-4 – 185)	40 (5800)	0.5 (100)
AWC825 (EU)	6 – 1320 (1/4 – 52)	-40 – 85 (-40 – 185)	52 (7500)	0.5 (100)
AWC830 (EU)	6 – 254 (1/4 – 10)	-35 – 75 (-30 – 175)	52 (7500)	0.9 (185)
AWC860 (EU)	6 – 508.0 (1/4 – 20)	-50 – 120 (-60 – 250)	103.5 (15000)	1.25 (250)

*Please contact your Chesterton representative for larger sizes.

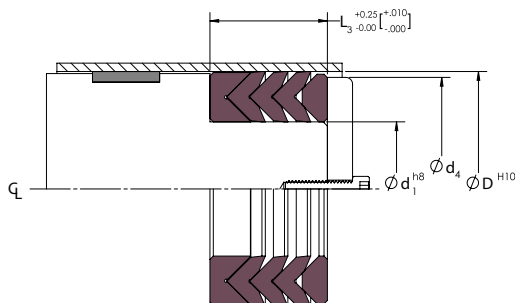

PRODUCT PROFILES



P28K

P28K1

P8K Piston Seals

Pressure-sensitive, Stacked Set for Hydraulic Sealing

The Chesterton 8K is a single-acting, stacked V-Ring set with a positive rake design to provide optimum operating performance in heavy-duty hydraulic piston applications. Unlike conventional stacked sets, these designs make contact through the center to provide even loading, minimize friction and provide longer sealing life.

The minimal gland pressure enables these sets to withstand greater sliding speed than conventional stacked sets. No readjustment of the seal precompression is needed after installation. The flared, pressure-sensitive lip design provides optimum sealing forces on seal rings, which are reactive to pressure thus reducing breakaway and frictional force.

The set is available in various material combinations to accommodate new or used equipment and can be supplied in solid design.

The P8K is a compression-molded stacked set that utilizes tooling to create a final product. Each set incorporates a male and female adapter to align and support the sealer rings.

Additional profiles have been derived from the original P8K design to address specific needs and applications in the market. These include designs for excessive clearances and deep piston head seal cavities.

SPECIFICATIONS



Material (designation)	Size Range* mm (inch)	Temperature °C (°F)	Pressure MPa (psi)	Speed m/s (ft/min)
AWC800 (EU)	6 – 1778 (1/4 – 70)	-50 – 85 (-60 – 185)	103.5 (15000)	1 (200)
AWC805 (EU)	6 – 1016 (1/4 – 40)	-50 – 85 (-60 – 185)	103.5 (15000)	0.5 (100)

*Please contact your Chesterton representative for larger sizes.

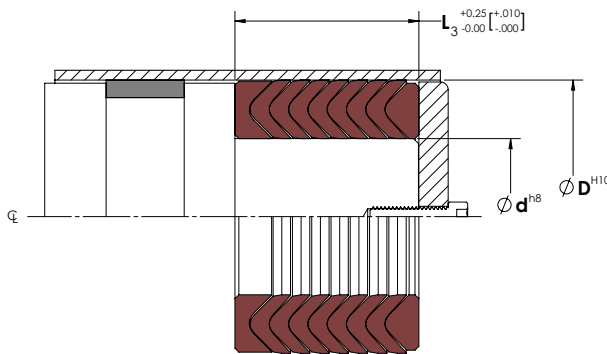

PRODUCT PROFILES

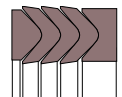

P8K



- Minimal gland pressure offers greater speed capability than conventional sets
- Even stack load design minimizes friction and extends service life
- Flared, pressure-sensitive lip; sealing forces are reactive to pressure
- Material combinations for use in both new and worn equipment

CHART 1 – P8K FLUID PRESSURE – SEAL RING CHART

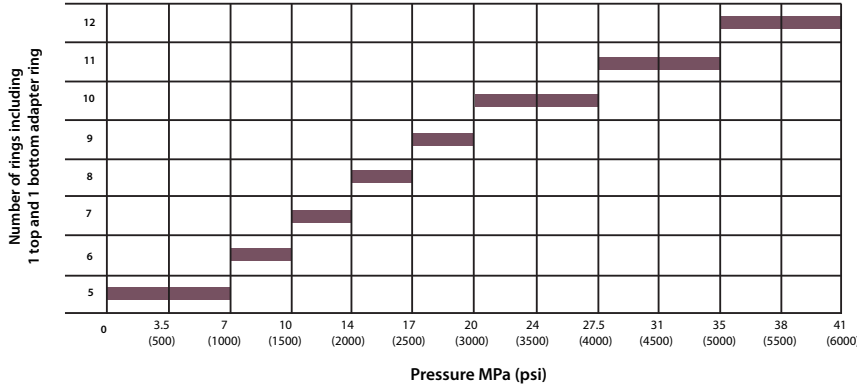

Determine the total number of rings required (including 1 top and 1 bottom adapter ring) based on pressure from Chart 1. For pressure 20 MPa (3000 psi) and above we suggest the use of an anti-extrusion ring. For pressure above 48 MPa (7000 psi), contact EPS Application Engineering. The minimum recommended seal set consists of a 5-ring set: 1 top adapter, 3 seal ring and 1 bottom adapter ring. Determine the approximate free stack height based on cross section and number of rings of the set from Chart 2 or Chart 3.

CHART 2 – P8K STACKED V-RING APPROXIMATE FREE STACK HEIGHT CHART - INCH

Cross Section Inches	P8K STACKED V-RING APPROXIMATE FREE STACK HEIGHT CHART							
Number of Rings	5 Rings	6 Rings	7 Rings	8 Rings	9 Rings	10 Rings	11 Rings	12 Rings
Cross Section mm (inch)	mm (inch)	mm (inch)	mm (inch)	mm (inch)	mm (inch)	mm (inch)	mm (inch)	mm (inch)
3.175 – 5.23 (0.125 – 0.206)	15.57 (0.613)	18.67 (0.735)	21.79 (0.858)	24.82 (0.977)	27.89 (1.098)	30.96 (1.219)	34.04 (1.340)	37.11 (1.461)
5.25 – 6.32 (0.207 – 0.249)	16.84 (0.663)	20.09 (0.791)	23.34 (0.919)	26.59 (1.047)	29.84 (1.175)	33.01 (1.303)	36.35 (1.431)	39.60 (1.559)
6.35 – 7.90 (0.250 – 0.311)	17.20 (0.677)	20.47 (0.806)	23.75 (0.935)	27.02 (1.064)	30.30 (1.193)	33.58 (1.322)	36.86 (1.451)	40.13 (1.580)
7.92 – 9.10 (0.312 – 0.358)	20.32 (0.800)	24.20 (0.953)	28.10 (1.106)	31.98 (1.259)	35.86 (1.412)	39.75 (1.565)	43.64 (1.718)	47.52 (1.871)
9.12 – 10.29 (0.359 – 0.405)	21.23 (0.836)	25.12 (0.989)	29.01 (1.142)	32.89 (1.295)	36.78 (1.448)	40.66 (1.601)	44.55 (1.754)	48.44 (1.907)
10.31 – 12.67 (0.406 – 0.499)	21.90 (0.862)	25.78 (1.015)	29.67 (1.168)	33.55 (1.321)	37.44 (1.474)	41.33 (1.627)	45.21 (1.780)	49.10 (1.933)
12.70 – 15.00 (0.500 – 0.592)	25.15 (0.990)	29.84 (1.175)	34.54 (1.360)	39.24 (1.545)	43.94 (1.730)	48.64 (1.915)	53.34 (2.100)	58.04 (2.285)
15.10 – 16.64 (0.593 – 0.655)	26.52 (1.044)	31.17 (1.227)	35.81 (1.410)	40.46 (1.593)	45.11 (1.776)	49.76 (1.959)	54.41 (2.142)	59.06 (2.325)
16.65 – 19.00 (0.656 – 0.749)	33.68 (1.326)	39.93 (1.572)	46.18 (1.818)	51.97 (2.046)	58.67 (2.310)	64.92 (2.556)	71.17 (2.802)	77.42 (3.048)
19.10 – 22.20 (0.750 – 0.874)	34.57 (1.361)	40.84 (1.608)	47.12 (1.855)	53.39 (2.102)	59.66 (2.349)	65.94 (2.596)	72.21 (2.843)	78.49 (3.090)
22.21 – 24.56 (0.875 – 0.967)	40.90 (1.610)	48.77 (1.920)	56.64 (2.230)	64.52 (2.540)	72.40 (2.850)	80.27 (3.160)	88.14 (3.470)	96.01 (3.780)
24.60 – 28.55 (0.968 – 1.124)	42.16 (1.660)	49.94 (1.966)	57.71 (2.272)	65.48 (2.578)	73.25 (2.884)	81.03 (3.190)	88.80 (3.496)	96.57 (3.802)
28.56 – 36.35 (1.125 – 1.431)	46.20 (1.819)	55.75 (2.195)	65.81 (2.591)	74.85 (2.947)	84.40 (3.323)	93.95 (3.699)	106.05 (4.175)	113.06 (4.451)

The approximate free stack height is calculated from the actual height of the top, bottom and sealer

CHART 3 – P8K STACKED V-RING APPROXIMATE FREE STACK HEIGHT CHART - METRIC

Cross Section mm	P8K STACKED V-RING APPROXIMATE FREE STACK HEIGHT CHART							
Number of Rings	5 Rings	6 Rings	7 Rings	8 Rings	9 Rings	10 Rings	11 Rings	12 Rings
Cross Section mm (inch)	mm (inch)	mm (inch)	mm (inch)	mm (inch)	mm (inch)	mm (inch)	mm (inch)	mm (inch)
5.0 – 7.9 (0.197 – 0.311)	16.70 (0.657)	19.90 (0.78)	23.10 (0.91)	26.30 (1.04)	29.50 (1.16)	32.70 (1.29)	35.90 (1.41)	39.10 (1.54)
8.0 – 10.0 (0.315 – 0.394)	21.06 (0.830)	25.02 (0.99)	28.98 (1.14)	32.94 (1.30)	36.90 (1.45)	40.86 (1.61)	44.82 (1.76)	48.78 (1.92)
10.1 – 12.0 (0.395 – 0.472)	22.14 (0.87)	26.10 (1.03)	30.06 (1.18)	34.02 (1.34)	37.98 (1.50)	41.94 (1.65)	45.90 (1.81)	49.86 (1.96)
12.1 – 14.9 (0.476 – 0.587)	25.00 (0.98)	29.60 (1.17)	35.20 (1.39)	38.8 (1.53)	43.40 (1.71)	48.00 (1.89)	52.60 (2.07)	57.20 (2.25)
15.0 – 17.9 (0.59 – 0.70)	27.73 (1.09)	32.45 (1.28)	37.17 (1.46)	41.89 (1.65)	46.61 (1.84)	51.33 (2.02)	56.05 (2.21)	60.77 (2.39)
18.0 – 22.0 (0.71 – 0.866)	35.94 (1.41)	42.70 (1.68)	49.56 (1.95)	56.42 (2.22)	63.61 (2.50)	70.14 (2.76)	77.00 (3.03)	83.06 (3.27)
22.1 and up (0.87 and up)	42.55 (1.68)	50.45 (1.99)	58.35 (2.30)	66.25 (2.61)	74.15 (2.92)	82.05 (3.23)	89.95 (3.54)	97.85 (3.85)
15.10 – 16.64 (0.593 – 0.655)	26.52 (1.044)	31.17 (1.227)	35.81 (1.410)	40.46 (1.593)	45.11 (1.776)	49.76 (1.959)	54.41 (2.142)	59.06 (2.325)
16.65 – 19.00 (0.656 – 0.749)	33.68 (1.326)	39.93 (1.572)	46.18 (1.818)	51.97 (2.046)	58.67 (2.310)	64.92 (2.556)	71.17 (2.802)	77.42 (3.048)
19.10 – 22.20 (0.750 – 0.874)	34.57 (1.361)	40.84 (1.608)	47.12 (1.855)	53.39 (2.102)	59.66 (2.349)	65.94 (2.596)	72.21 (2.843)	78.49 (3.090)
22.21 – 24.56 (0.875 – 0.967)	40.90 (1.610)	48.77 (1.920)	56.64 (2.230)	64.52 (2.540)	72.40 (2.850)	80.27 (3.160)	88.14 (3.470)	96.01 (3.780)
24.60 – 28.55 (0.968 – 1.124)	42.16 (1.660)	49.94 (1.966)	57.71 (2.272)	65.48 (2.578)	73.25 (2.884)	81.03 (3.190)	88.80 (3.496)	96.57 (3.802)
28.56 – 36.35 (1.125 – 1.431)	46.20 (1.819)	55.75 (2.195)	65.81 (2.591)	74.85 (2.947)	84.40 (3.323)	93.95 (3.699)	106.05 (4.175)	113.06 (4.451)

The approximate free stack height is calculated from the actual height of the top, bottom and sealer

P27K Piston Seals

Pressure-sensitive, Stacked Set for Hydraulic Sealing

The Chesterton P27K is a single-acting, stacked V-Ring set with a positive rake design to provide optimum operating performance in heavy-duty hydraulic piston applications. Unlike conventional stacked sets, these designs make contact through the center to provide even loading, minimize friction, and provide longer sealing life.

The minimal gland pressure enables these sets to withstand greater sliding speed than conventional stacked sets. No readjustment of the seal precompression is needed after installation. Flared, pressure-sensitive lip design provides optimum sealing forces on seal rings, which are reactive to pressure thus reducing breakaway and frictional force.

The set is available in various material combinations to accommodate new or used equipment and can be supplied in solid design.

The P27K is manufactured using a machining process which allows the flexibility to create any size based on equipment dimensions and eliminates tooling cost for new sizes. Each set incorporates a male and female adapter to align and support the sealer rings. P27Ks are delivered as solid sets only.

Additional profiles have been derived from the original P27K design to address specific needs and applications in the market. These include designs for excessive clearances and deep stuffing boxes.



- Minimal gland pressure offers greater speed capability than conventional sets
- Even stack load design minimizes friction and extends service life
- Flared, pressure-sensitive lip; sealing forces are reactive to pressure
- Material combinations for use in both new and worn equipment

SPECIFICATIONS



Material (designation)	Size Range* mm (inch)	Temperature °C (°F)	Pressure MPa (psi)	Speed m/s (ft/min)
AWC704 (FKM)	6 – 304.8 (1/4 – 12)	-30 – 200 (-20 – 400)	16 (2320)	1.5 (300)
AWC800 (EU)	6 – 1320 (1/4 – 52)	-50 – 85 (-60 – 185)	103.5 (15000)	1 (200)
AWC808 (EU)	6 – 400 (1/4 – 15.75)	-20 – 85 (-4 – 185)	40 (5800)	0.5 (100)
AWC825 (EU)	6 – 1320 (1/4 – 52)	-40 – 85 (-40 – 185)	52 (7500)	0.5 (100)
AWC830 (EU)	6 – 254 (1/4 – 10)	-35 – 75 (-30 – 175)	52 (7500)	0.9 (185)
AWC860 (EU)	6 – 508.0 (1/4 – 20)	-50 – 120 (-60 – 250)	103.5 (15000)	1.25 (250)

*Please contact your Chesterton representative for larger sizes.

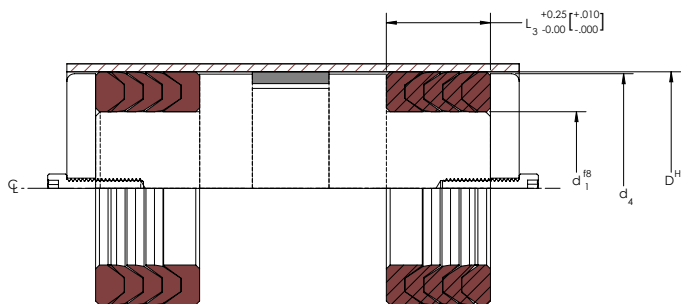

PRODUCT PROFILES



P27K



P27K1

CHART 1 – P27K FLUID PRESSURE - SEAL RING CHART

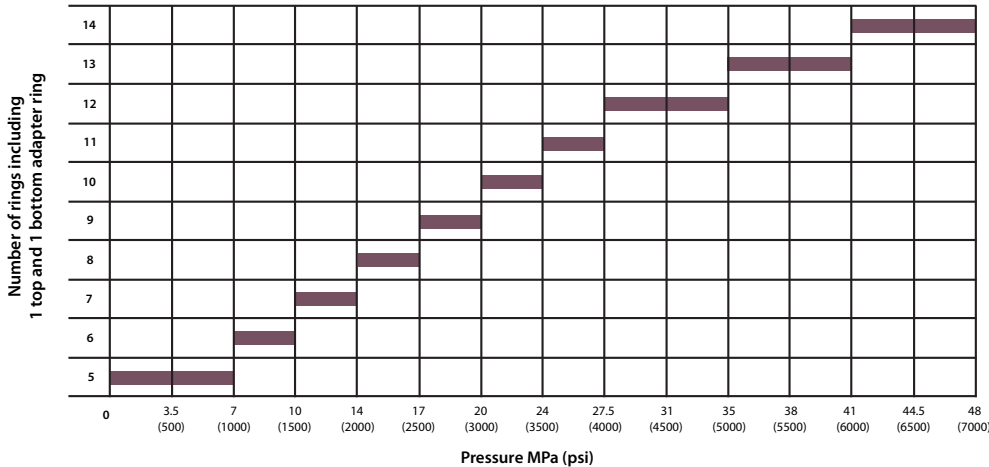

Determine the total number of rings required (including 1 top and 1 bottom adapter ring) based on pressure from Chart 1. For pressure 20 MPa (3000 psi) and above we suggest the use of an anti-extrusion rRing. For pressure above 48 MPa (7000 psi), contact EPS Application Engineering. The minimum recommended seal set consists of a 5-ring set: 1 top adapter, 3 seal ring and 1 bottom adapter ring. Determine the approximate free stack height based on cross section and number of rings of the set from Chart 2.

CHART 2 – P27K V-RING APPROXIMATE FREE STACK HEIGHT CHART

Number of Rings	5 Rings	6 Rings	7 Rings	8 Rings	9 Rings	10 Rings	11 Rings	12 Rings	13 Rings	14 Rings
Pressure Rating MPa (psi)	7 (1000)	10 (1500)	14 (2000)	17 (2500)	20 (3000)	24 (3500)	27.5 (4000)	35 (5000)	41 (6000)	48 (7000)
CROSS SECTION mm (inch)	mm (inch)	mm (inch)	mm (inch)	mm (inch)	mm (inch)	mm (inch)	mm (inch)	mm (inch)	mm (inch)	mm (inch)
3.172 ≤ S < 4.773 (0.1249 ≤ S < 0.1879)	12.04 (0.474)	13.94 (0.549)	15.85 (0.624)	17.75 (0.699)	19.66 (0.774)	21.56 (0.849)	23.47 (0.924)	25.40 (1.000)	27.28 (1.074)	29.18 (1.149)
4.773 ≤ S < 6.348 (0.1879 ≤ S < 0.2499)	16.10 (0.634)	19.18 (0.755)	22.25 (0.876)	25.32 (0.997)	28.40 (1.118)	31.47 (1.239)	34.54 (1.360)	37.62 (1.481)	40.69 (1.602)	43.76 (1.723)
6.348 ≤ S < 7.948 (0.2499 ≤ S < 0.3129)	16.83 (0.66)	19.99 (0.787)	23.22 (0.914)	26.44 (1.041)	29.67 (1.168)	32.69 (1.287)	36.12 (1.422)	39.34 (1.549)	42.57 (1.676)	45.80 (1.803)
7.948 ≤ S < 9.523 (0.3129 ≤ S < 0.3749)	20.55 (0.809)	24.51 (0.965)	28.47 (1.121)	32.44 (1.277)	36.40 (1.433)	40.36 (1.589)	44.32 (1.745)	48.29 (1.901)	52.25 (2.057)	56.21 (2.213)
9.523 ≤ S < 11.123 (0.3749 ≤ S < 0.4379)	21.49 (0.846)	25.5 (1.004)	29.51 (1.162)	33.53 (1.320)	37.54 (1.478)	41.55 (1.636)	45.57 (1.794)	49.58 (1.952)	53.59 (2.110)	57.60 (2.268)
11.123 ≤ S < 12.698 (0.4379 ≤ S < 0.4999)	22.50 (0.886)	26.57 (1.046)	30.63 (1.206)	34.70 (1.366)	38.76 (1.526)	42.82 (1.686)	46.89 (1.846)	50.95 (2.006)	55.02 (2.166)	59.08 (2.326)
12.698 ≤ S < 14.298 (0.4999 ≤ S < 0.5629)	25.30 (0.996)	29.97 (1.180)	34.65 (1.364)	39.32 (1.548)	43.99 (1.732)	48.67 (1.916)	53.34 (2.100)	58.01 (2.284)	62.69 (2.468)	67.36 (2.652)
14.298 ≤ S < 15.873 (0.5629 ≤ S < 0.6249)	26.42 (1.040)	31.12 (1.225)	35.81 (1.410)	40.51 (1.595)	45.21 (1.780)	49.91 (1.965)	54.61 (2.150)	59.31 (2.335)	64.01 (2.520)	68.71 (2.705)
15.873 ≤ S < 17.473 (0.6249 ≤ S < 0.6879)	28.50 (1.122)	33.81 (1.331)	39.12 (1.540)	44.42 (1.749)	49.73 (1.958)	55.04 (2.167)	60.35 (2.376)	65.666 (2.585)	70.97 (2.794)	76.28 (3.003)
17.473 ≤ S < 19.048 (0.6879 ≤ S < 0.7499)	33.76 (1.329)	40.03 (1.576)	46.3 (1.823)	52.58 (2.070)	58.85 (2.317)	65.13 (2.564)	71.40 (2.811)	77.67 (3.058)	83.95 (3.305)	90.22 (3.552)
19.048 ≤ S < 22.223 (0.7499 ≤ S < 0.8749)	34.49 (1.358)	40.77 (1.605)	47.04 (1.852)	53.31 (2.099)	59.59 (2.346)	65.86 (2.593)	72.14 (2.840)	78.41 (3.087)	84.69 (3.334)	90.96 (3.581)
22.223 ≤ S < 23.823 (0.8749 ≤ S < 0.9379)	40.77 (1.605)	48.54 (1.911)	56.31 (2.217)	64.08 (2.523)	71.86 (2.829)	79.63 (3.135)	87.40 (3.441)	95.17 (3.747)	102.95 (4.053)	110.72 (4.359)
23.823 ≤ S < 25.398 (0.9379 ≤ S < 0.9999)	40.77 (1.605)	48.54 (1.911)	56.31 (2.217)	64.08 (2.523)	71.86 (2.829)	79.63 (3.135)	87.40 (3.441)	95.17 (3.747)	102.95 (4.053)	110.72 (4.359)
25.398 ≤ S < 26.998 (0.9999 ≤ S < 1.0629)	43.69 (1.720)	51.64 (2.033)	59.59 (2.346)	67.54 (2.659)	75.49 (2.972)	83.44 (3.285)	91.39 (3.598)	99.34 (3.911)	107.29 (4.224)	115.24 (4.537)
26.998 ≤ S < 30.173 (1.0629 ≤ S < 1.1879)	44.704 (1.760)	52.73 (2.075)	60.76 (2.392)	68.78 (2.708)	76.81 (3.024)	84.84 (3.340)	92.86 (3.656)	100.89 (3.972)	108.92 (4.288)	116.94 (4.604)
30.173 ≤ S < 31.748 (1.1879 ≤ S < 1.2499)	52.10 (2.051)	61.8 (2.433)	71.5 (2.815)	81.20 (3.197)	90.91 (3.579)	100.61 (3.961)	110.31 (4.343)	120.02 (4.725)	129.72 (5.107)	139.42 (5.489)
31.748 ≤ S < 33.348 (1.2499 ≤ S < 1.3129)	52.91 (2.083)	62.61 (2.465)	72.31 (2.847)	82.02 (3.229)	91.72 (3.611)	101.42 (3.993)	111.13 (4.375)	120.83 (4.757)	130.53 (5.139)	140.23 (5.521)

P11K Piston Seals

Dual-component Stacked Set for Hydraulic Sealing

The Chesterton patented P11K EZ Stack Pack is a single-acting, two-piece split stacked set that employs a negative rake lip profile to optimize operating performance while easing installation into the piston head seal cavity. The unique design made up of two components eliminates the need for shimming and is recommended for use in hydraulic cylinders and presses.

The bottom ring is the primary sealer while the top ring provides secondary sealing and works as an anti-extrusion ring. The set is available in various material combinations to accommodate new or used equipment and can be supplied in solid designs only.

The P11K EZ Stack Pack can be manufactured using either the traditional compression molded process or a machining process which allows the flexibility to create any size based on equipment dimensions.

A tailored system can be built on the base of P11K in combination with Chesterton 9K Anti-Extrusion Ring and spacer/stand-off rings up. This adaptive module system allows for creating the most suitable seal kit for all kind of heavy-duty and demanding hydraulic cylinder applications and operating conditions. A flexible, modular, and custom-tailored system is the optimum solution for replacement of conventional heavy-duty stacked sets.

SPECIFICATIONS



Material (designation)	Size Range* mm (inch)	Temperature °C (°F)	Pressure MPa (psi)	Speed m/s (ft/min)
AWC704 (FKM)	6 – 304.8 (1/4 – 12)	-30 – 200 (-20 – 400)	16 (2320)	1.5 (300)
AWC800 (EU)	6 – 2540 (1/4 – 100)	-50 – 85 (-60 – 185)	103.5 (15000)	1 (200)
AWC805 (EU)	6 – 2540 (1/4 – 100)	-50 – 85 (-60 – 185)	103.5 (15000)	0.5 (100)
AWC808 (AU)	6 – 400 (1/4 – 15.75)	-20 – 85 (-4 – 185)	40 (5800)	0.5 (100)
AWC825 (EU)	6 – 2540 (1/4 – 100)	-40 – 85 (-40 – 185)	52 (7500)	0.5 (100)
AWC830 (EU)	6 – 254 (1/4 – 10)	-35 – 75 (-30 – 175)	52 (7500)	0.9 (185)
AWC860 (EU)	6 – 508.0 (1/4 – 20)	-50 – 120 (-60 – 250)	103.5 (15000)	1.25 (250)

*Please contact your Chesterton representative for larger sizes.

Applicable standard: ISO 5597

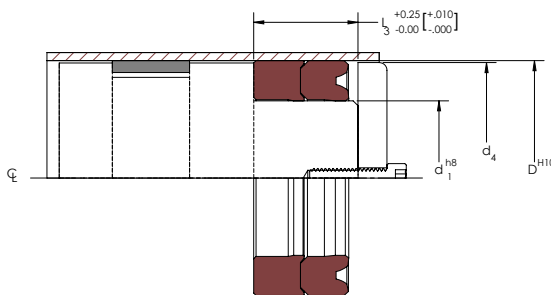

PRODUCT PROFILES



P11K



P11KSPCR



P11KWSOR

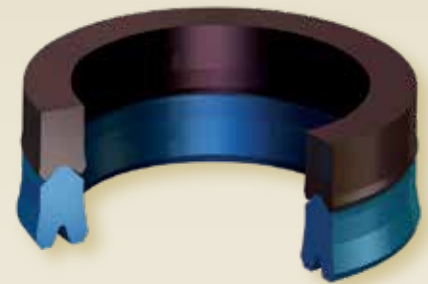

- Replaces the stacked set assemblies
- One optimized seal concept for different press applications
- Negative lip profile optimizes operating performance and eases installation
- No shimming; eliminates tedious calculations and future adjustments
- Dual material combination works on both new and worn equipment

Mining Never Stops.

Neither should your equipment.



Chesterton's cylinder upgrade kits for off-highway mobile mining equipment maximize equipment productivity. Our exclusive seal material technology helps keeps your equipment running longer, increasing reliability and reducing costs.

- Turnkey cylinder rebuild kits
- Increase hours of operation

For more information go to
www.chesterton.com



P20K Piston Seals

Heavy-duty, Bidirectional, Low-Speed Hydraulic Sealing

Chesterton P20K is a continuous, bidirectional compression seal with dual independent sealing points for hydraulic piston applications. The robust, durable, dual lip profile is used for single groove cavities in heavy-duty, high-pressure, hydraulic applications.

The entire seal cross section of the seal is preloaded by the seal groove when installed to provide tight sealing even at low pressure thus reducing the risk of fluid bypass from start-up. When the system pressure increases the hydraulic fluid energizes the seal, increasing the sealing area and sealing efficiency of the component.

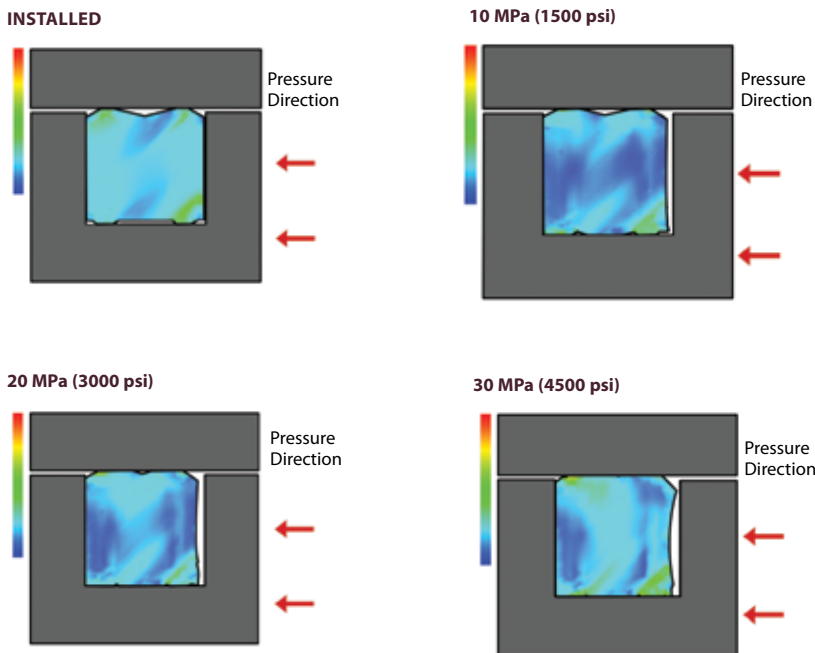

The heavy-duty seal design with incorporated anti-extrusion ring helps P20K to withstand transverse loads and extreme pressure conditions, just like pressure peaks and shock load during operation and it further increases extrusion resistance of the seal component at larger clearances. 20K is an ideal solution for static and dynamic applications even in the most demanding applications.

The P20K Duoseals are made from our unique machining process which eliminates the need for tooling costs associated with new sizes.

Additional designs were developed for specific application and equipment needs including the incorporation of various anti-extrusion devices for combating excessive clearances and pressure spikes.



- Reduces risk of fluid bypass from start-up of the hydraulic system
- Ideal replacement for 2-, 3-, or 4-piece cap seal and compression seal assemblies
- Superior extrusion, transverse load, and wear resistance
- Ideal solution for static and dynamic applications
- Unique manufacturing process allows the flexibility to create any size



SPECIFICATIONS

Material (designation)	Size Range* mm (inch)	Temperature °C (°F)	Pressure MPa (psi)	Speed m/s (ft/min)
AWC704 (FKM)	6 – 304.8 (1/4 – 12)	-30 – 200 (-20 – 400)	16 (2320)	1.5 (300)
AWC800 (EU)	6 – 2540 (1/4 – 100)	-50 – 85 (-60 – 185)	103.5 (15000)	1 (200)
AWC808 (AU)	6 – 400 (1/4 – 15.75)	-20 – 85 (-4 – 185)	40 (5800)	0.5 (100)
AWC825 (EU)	6 – 2540 (1/4 – 100)	-40 – 85 (-40 – 185)	52 (7500)	0.5 (100)
AWC830 (EU)	6 – 254 (1/4 – 10)	-35 – 75 (-30 – 175)	52 (7500)	0.9 (185)
AWC860 (EU)	6 – 508.0 (1/4 – 20)	-50 – 120 (-60 – 250)	103.5 (15000)	1.25 (250)

*Please contact your Chesterton representative for larger sizes.
Applicable standard: ISO 6547

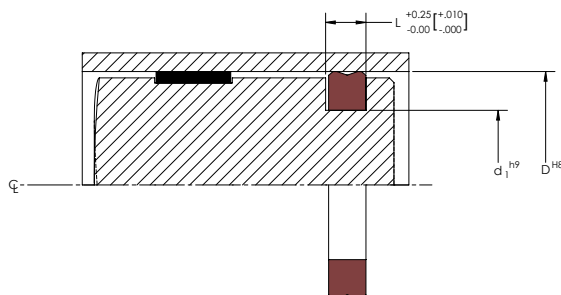

PRODUCT PROFILES

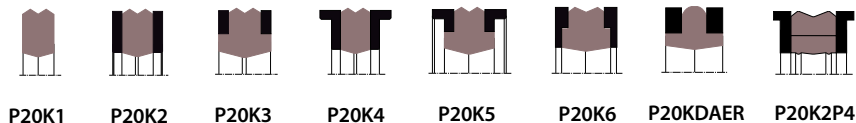

PCCS Piston Seals

Dual-component Cap Seals for Hydraulic and Pneumatic Sealing

Chesterton Piston Custom Cap Seals (PCCS) are custom-manufactured, dual-component seals for piston application. This cap seal design is comprised of a two-piece, sealing system that uses a rubber energizer and high performance plastic cap, creating very effective sealing and providing long service life. PCCS meets demanding operating conditions, where high sliding speed, elevated operating temperature, or hydraulic media compatibility challenges the seals or low friction is required. PCCS is an ideal sealing solution for a broad range of hydraulic and pneumatic applications.

The cap is used as the dynamic sealing element while the rubber energizer activates the cap and creates a static seal. The rubber energizer provides flexibility and support cap rings compensate for possible radial movements. The cap ring is preloaded with adequate contact surface to retain hydraulic media at zero or low pressure. Higher system pressure actuates the rubber energizer which compresses the cap ring more against the cylinder bore which increases sealing surface and sealing efficiency.

Special plastic compounds of the cap rings have low frictional characteristics. The most common materials are second-generation PTFE compounds and high performance thermoset polyurethanes. Such materials provide low breakaway and frictional force, so reducing the risk of stick-slip effect.

Each cap seal is made from our machining process which eliminates the need for tooling costs associated with new sizes. PCCS designs include single- and double-acting, single cavity versions.

Additional designs were developed for specific application and equipment needs. Both components are available in a range of engineered materials to best suit the specific operating requirements.

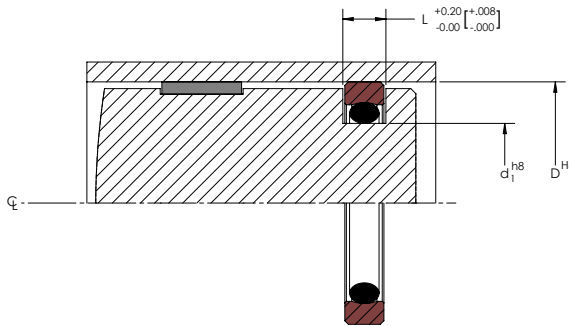

PRODUCT PROFILES

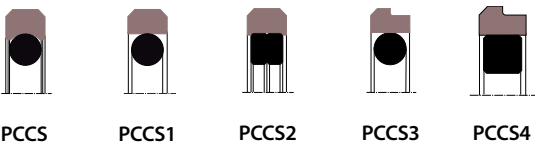

- Second-generation PTFE compounds and high performance polyurethanes offer improved performance
- Compression seal design increases sealing force with system pressure
- Proven seal design provides predictable performance
- Low breakaway and frictional force for smooth movement; reducing risk of stick-slip
- High performance solutions for the most demanding hydraulic and pneumatic applications



SPECIFICATIONS

Material (designation)	Size Range* mm (inch)	Temperature °C (°F)	Speed m/s(ft/min) Reciprocating
**AWC800 (EU)	6 – 1320 (1/4 – 52)	-50 – 85 (-60 – 185)	1(200)
**AWC808 (AU)	6 – 400 (1/4 – 15.75)	-20 – 85 (-4 – 185)	0.5(100)
**AWC830 (EU)	6 – 254 (1/4 – 10)	-35 – 75 (-30 – 175)	0.9(185)
**AWC860 (EU)	6 – 508.0 (1/4 – 20)	-50 – 120 (-60 – 250)	1.25(250)
***AWC300 (Glass-Filled PTFE)	up to 600 (24)	-35 – 120 (-30 – 250)	15(3000)
***AWC400 (Carbon-Filled PTFE)	up to 600 (24)	-35 – 120 (-30 – 250)	15(3000)
***AWC500 (Bronze-Filled PTFE)	up to 600 (24)	-35 – 120 (-30 – 250)	15(3000)
***AWC520 (Virgin PTFE)	up to 600 (24)	-35 – 120 (-30 – 250)	15(3000)

*Please contact your Chesterton representative for larger sizes.

**O-Ring material is NBR

***O-Ring material is FKM

Applicable standard: ISO 7425-1

RECOMMENDED GROOVE DIMENSIONS - METRIC

Bore Diameter Range mm			Piston Seal Groove Diameter	Seal Groove Height	Seal Cross Section	Radius	Diametrical Clearance (mm)		O-Ring Cross Section
Heavy-Duty	Medium-Duty	Light-Duty	d ₁ H8 (mm)	L (+200/-0) (mm)	C/S (mm)	R (mm)	0 – 20 MPa	20 – 40 MPa	OR (mm)
-	8.0 – 14.9	15.0 – 39.9	D – 4.90	2.20	2.45	0.40	0.40	0.30	1.78
-	15.0 – 39.9	40.0 – 79.9	D – 7.50	3.20	3.75	0.60	0.50	0.30	2.62
15.0 – 39.9	40.0 – 79.9	80.0 – 132.9	D – 11.00	4.20	5.50	0.80	0.50	0.30	3.53
40.0 – 79.9	80.0 – 132.9	133.0 – 329.9	D – 15.50	6.30	7.75	1.00	0.60	0.40	5.33
80.0 – 132.9	133.0 – 329.9	330.0 – 669.9	D – 21.00	8.10	10.50	1.50	0.60	0.40	6.99
133.0 – 329.9	330.0 – 669.9	670.0 – 1000	D – 24.50	8.10	12.25	1.50	0.70	0.50	6.99
330.0 – 669.9	670.0 – 1000	1,000 +	D – 28.00	9.50	14.00	2.00	0.8	0.60	8.40
670.0 – 1000	1,000 +	-	D – 28.00	9.50	14.00	2.50	1.20	1.00	8.40

RECOMMENDED GROOVE DIMENSIONS - INCH

Bore Diameter Range inch			Piston Seal Groove Diameter	Seal Groove Height	Seal Cross Section	Radius	Diametrical Clearance (inch)		O-Ring Cross Section
Heavy-Duty	Medium-Duty	Light-Duty	d ₁ H8 (inch)	L (+.008/-0) (inch)	C/S (inch)	R (inch)	0 – 3000 psi	3000 to 6000 psi	OR (inch)
-	0.118 – 0.311	0.311	D – .193	0.087	0.096	0.016	0.016	0.012	0.070
-	0.315 – 0.744	0.744	D – .295	0.126	0.148	0.024	0.020	0.012	0.103
0.315 – 0.744	0.748 – 1.492	1.492	D – .433	0.165	0.217	0.031	0.020	0.012	0.139
0.748 – 1.492	1.496 – 7.870	7.870	D – .610	0.248	0.305	0.039	0.024	0.016	0.210
1.496 – 7.870	7.874 – 10.075	10.075	D – .827	0.319	0.413	0.059	0.024	0.016	0.275
7.874 – 10.075	10.079 – 25.587	25.587	D – .965	0.319	0.482	0.059	0.028	0.020	0.275
10.079 – 25.587	25.591 – 39.366	39.366	D – 1.102	0.374	0.551	0.079	0.031	0.024	0.331
25.591 – 39.366	39.370 +	-	D – 1.102	0.374	0.551	0.098	0.047	0.039	0.331

20KD Face and Static Seals

High Performance O-Ring Upgrade for Static Sealing

Chesterton 20K D-Ring is a continuous compression seal designed for use in static applications and is often applied as an upgrade from conventional face seals or O-Ring designs. That is why 20K D-Rings are interchangeable for O-Ring housing and O-Ring designs with back-up rings. 20K D-Ring design provides excellent performance in static applications found in hydraulic or pneumatic equipment including flange and valve control units.

The optimum design provides minimum seal deformation by better fit in the seal cavity and excellent pressure distribution through the seal cross section, by working with better geometrical and dimensional stability (Figure 1.). 20K D-Rings can withstand higher operating pressure compared to conventional O-Rings.



- Upgrade performance of conventional face seal and O-Ring designs
- Superior wear and extrusion resistance versus conventional materials
- Low compression set characteristics
- Unique manufacturing process allows the flexibility to create any size
- Sizes made to accommodate international standards including ISO

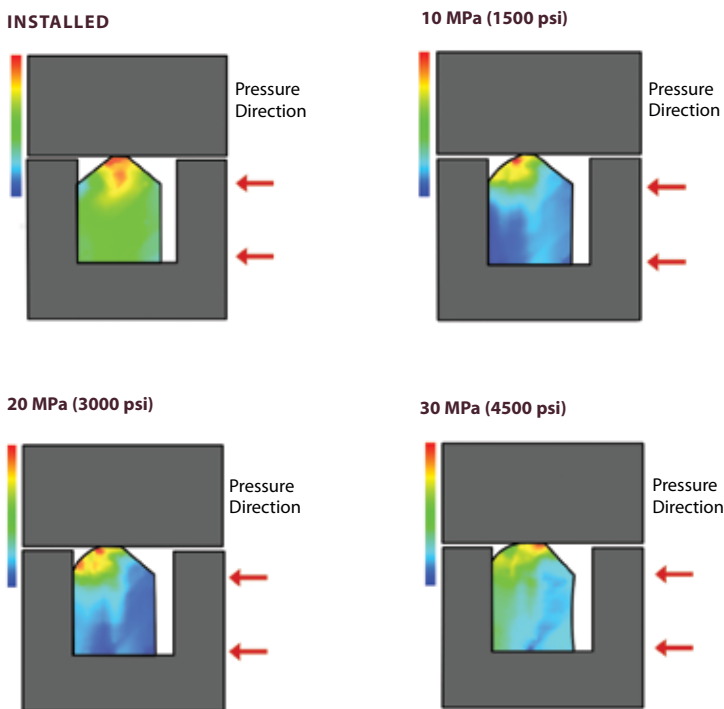

Figure 1. How the 20K D-Ring performs installed and under pressure

20K D-Rings are manufactured from high extrusion-resistant polyurethane materials, which helps to prolong seal service life and improve reliability even in critical high-pressure, heavy-duty hydraulic applications.

Each seal is individually manufactured from our high-precision CNC machining process which eliminates the need for tooling costs associated with new sizes. Designs are available for internal face sealing as well as external face sealing commonly found in single- or double-acting applications.



SPECIFICATIONS

Material (designation)	Size Range* mm (inch)	Temperature °C (°F)	Pressure MPa (psi)
AWC704 (FKM)	6 – 304.8 (1/4 – 12)	-30 – 200 (-20 – 400)	16 (2320)
AWC800 (EU)	6 – 2540 (1/4 – 100)	-50 – 85 (-60 – 185)	103.5 (15000)
AWC808 (AU)	6 – 400 (1/4 – 15.75)	-20 – 85 (-4 – 185)	40 (5800)
AWC825 (EU)	6 – 2540 (1/4 – 100)	-40 – 85 (-40 – 185)	52 (7500)
AWC830 (EU)	6 – 254 (1/4 – 10)	-35 – 75 (-30 – 175)	52 (7500)
AWC860 (EU)	6 – 508.0 (1/4 – 20)	-50 – 120 (-60 – 250)	103.5 (15000)

* Please contact your Chesterton representative for larger sizes.
 Applicable standard: ISO 3601-2

PISTON APPLICATION

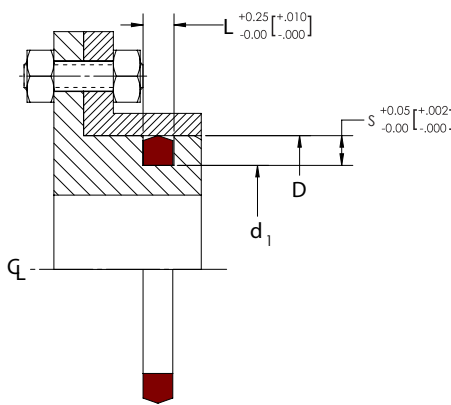

ROD APPLICATION

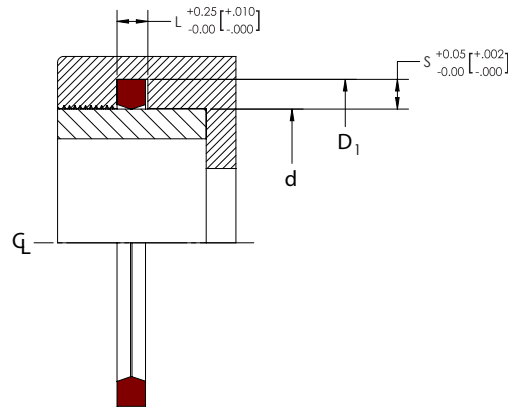

AXIAL APPLICATION

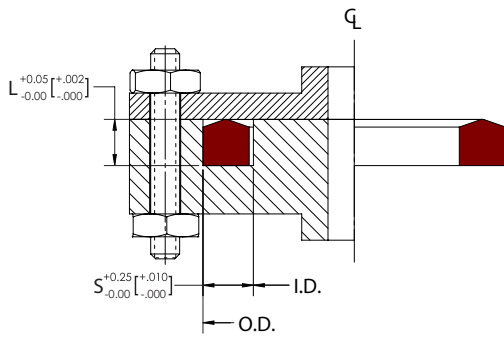

PRODUCT PROFILES



R20KDR 20KDRFS P20KDR OR1 20KOR OR

9K Anti-extrusion Rings

Prevent Extrusion of Dynamic and Static Seals

Chesterton 9K Anti-extrusion Rings, often referred to as back-up rings, have no intended sealing function. 9K provides protection to pressurized dynamic and static seals (including O-Rings) from extruding into equipment clearances while under pressure thus protecting seal components from premature failure and prolonging their service life. Protection is provided by tight fit of the anti-extrusion rings in the seal groove to minimize the extrusion gap. In addition, 9K provides support to seals, which improves the seal's high-pressure handling capability and can assist seals in compensating for large temperature fluctuations.

9K anti-extrusion rings are recommended to use when:

- Hydraulic system pressure exceeds the seal's extrusion resistance limitation
- Fluid pressure spikes exceed the normal system pressure
- The system temperature is high enough to lower the extrusion resistance of the seal
- The use of nonmetallic bearing bands increases the radial clearance and extrusion gap

9K rings are installed in the seal cavity together with either the elastomer or polyurethane sealing element located on the backside or low-pressure side of the sealing element they are supporting. In case of double-acting seals, anti-extrusion rings are located on both sides of the seal.

9K anti-extrusion rings are available in various extrusion-resistant materials (high durometer engineered plastics) and custom profiles. The most popular design is with a rectangular cross section however other profiles such as contoured and concave cross sections are available as well. Concave design provides larger contact areas to prevent excessive deformation of the O-Rings and to improve dimensional stability for the best performance. Split design options, for ease of installation, are available.

Each ring is individually manufactured and provides excellent performance, as a supporting element, to both piston, rod, and face seals that are generally found in static or dynamic applications.

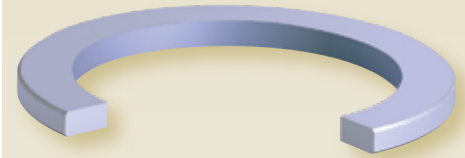

- Provide protection against extrusion of sealing elements into equipment clearances; improve MTBR
- Improve high-pressure handling capability of the seals
- Static and dynamic applications; plant-wide usage
- Machining process allows the flexibility to create any size
- Available in various profiles and materials

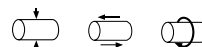

SPECIFICATIONS

Material (designation)	Size Range* mm (inch)	Temperature °C (°F)
AWC650 (Acetal)	6 – 381 (1/4 – 15)	-30 – 90 (-20 – 200)
AWC663 (Nylon)	6 – 600 (1/4 – 23.62)	-40 – 105 (-40 – 212)
AWC665 (Nylon with MoS ₂)	6 – 1320 (1/4 – 52)	-40 – 105 (-40 – 212)
AWC800 (EU)	6 – 1320 (1/4 – 52)	-50 – 85 (-60 – 185)
AWC808 (AU)	6 – 400 (1/4 – 15.75)	-20 – 85 (-4 – 185)
AWC860 (EU)	6 – 508.0 (1/4 – 20)	-50 – 120 (-60 – 250)
AWC300 (Glass-Filled PTFE)	6 – 600 (1/4 – 23.62)	-35 – 120 (-30 – 250)
AWC400 (Carbon-Filled PTFE)	6 – 600 (1/4 – 23.62)	-35 – 120 (-30 – 250)
AWC500 (Bronze-Filled PTFE)	6 – 600 (1/4 – 23.62)	-35 – 120 (-30 – 250)
AWC520 (Virgin PTFE)	6 – 600 (1/4 – 23.62)	-35 – 120 (-30 – 250)
AWC630 (Unfilled PEEK)	6 – 152 (1 – 6)	-45 – 175 (-50 – 350)
AWC635 (Glass-Filled PEEK)	6 – 152 (1 – 6)	-45 – 175 (-50 – 350)

* Please contact your Chesterton representative for larger sizes.

PISTON APPLICATION

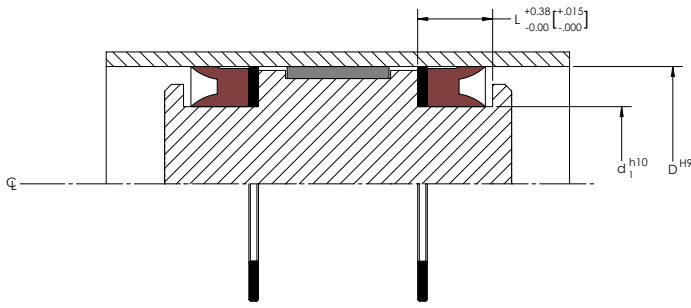

ROD APPLICATION

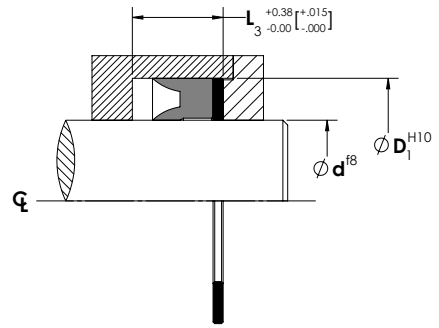

PRODUCT PROFILES

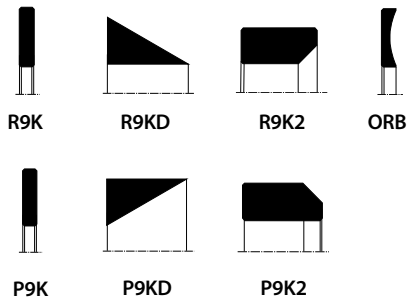

18K and 19K Wear Rings

High Performance, Replaceable Wear Rings for Cylinders

Chesterton replaceable wear rings are the solution to costly cylinder remachining and repairs for medium- to heavy-duty hydraulic or pneumatic equipment. These split, replaceable wear rings reduce probability of metal-to-metal contact of moving parts and help prolong equipment life. When installed during the cylinder repair, the risk of recurring damage is significantly reduced.

The easy-to-use split 18K and 19K designs are manufactured from a glass fiber-reinforced thermoplastic polyimide resin (heat stabilized nylon) for high bearing capacity and are capable of supporting transverse loads. These wear rings reduce radial movement therefore helping to extend seal life. The lower Young's modulus and higher material flexibility (compared to metal bearings) let the nonmetallic wear rings have more elastic deformation under load and the larger contact area will transfer the load and cause lower surface pressure.

The exceptional physical properties allow for use in a broad range of temperature conditions and provide excellent fluid compatibility. The built-in lubricants help to reduce friction between mating surfaces and reduce risk of fretting and seizing, which further provides good dry running capabilities. 18K and 19K wear rings have excellent dimensional stability.

The use of nonmetallic wear rings helps to prevent the buildup of hydrodynamic pressure in small clearances of the cylinders and helps to prevent diesel effect.

The precise manufacturing technology of the 18K and 19K wear rings provides accurate dimensional and geometrical tolerances, and improved fitting. According to industrial standards sizing, the 18K and 19K are a direct retrofit to existing wear ring grooves which eliminates the need for equipment modification.

The split design makes the installation of the cut wear rings easy (snap-in fitting), allowing them to be universally used on either rods, rams, or pistons in reciprocating applications.

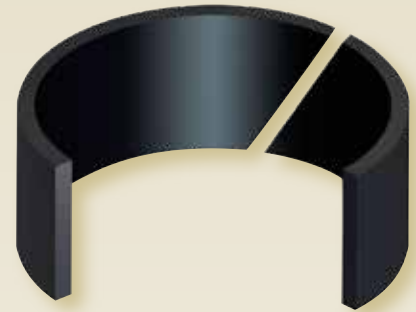

- Heat stabilized nylon with high bearing-load capacity for medium- to heavy-duty applications
- Replaceable wear rings prevent metal-to-metal scoring and prolong equipment life
- Reduce radial movement, therefore extending seal life
- Retrofit existing wear rings grooves and eliminate unnecessary modifications
- Split design minimizes downtime

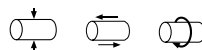

SPECIFICATIONS

Material (designation)	Size Range* mm (inch)	Temperature °C (°F)	Compressive Strength MPa (psi) ASTM D965	Permissible Compressive Load MPa (psi)	Speed m/sec (ft/min)
AWC660 40% (Glass-Filled Nylon)	to 500 (20)	-40 – 121 (-40 – 250)	158.6 (23,000)	55 (7,975)	1.25 (250)

PRODUCT PROFILES



18K

19K

PISTON APPLICATION

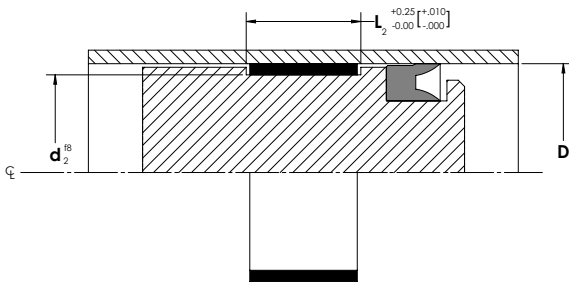

ROD APPLICATION

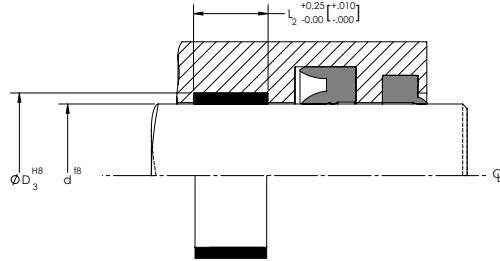

18K METRIC DESIGN

Cross Section (S) mm	Height (H ₁) mm	Diameter Range (d/D) mm
0.125	0.375	1 – 4
	0.500	1.5 – 6
	0.750	3.5 – 8
	1.000	4 – 20

19K METRIC DESIGN

Cross Section (S) mm	Height (H ₁) mm	Diameter Range (d/D) mm
2.5	5	20 – 140
	9	55 – 220
	14	70 – 400
	24	315 – 400

WR Custom Wear Rings

Custom Replacement Bearing Bands

Chesterton Custom Wear Rings (WR) are the solution to costly cylinder remachining and repairs for pneumatic and light- to heavy-duty hydraulic equipment. These split, replaceable wear rings reduce probability of metal-to-metal contact of moving parts and help prolong equipment life. When installed during the cylinder repair, the risk of recurring damage is significantly reduced.

The easy-to-use split WR designs are manufactured from various engineered plastic materials to provide the best possible bearing solution based on operating condition and hardware configuration. Utilized plastic compounds have good bearing capacity and are capable of supporting transverse loads. These bearings reduce radial movement therefore helping to extend seal life.

The use of nonmetallic wear rings helps to prevent the buildup of hydrodynamic pressure in small clearances of the cylinders and helps to prevent diesel effect. Each seal is individually manufactured from our unique machining process which eliminates the need for tooling costs associated with new sizes.

The precise CNC lathe manufacturing technology of the WR provides accurate dimensional and geometrical tolerances, and improved fitting. Flexible manufacturing technology allows to virtually produce any size and shape thus providing retrofit bearing solutions.

Various designs and materials are available including the WR, P9KL, R9KL, WRTP, WRTR, WRUP, and WRUR which address specific needs and applications in the market.

SPECIFICATIONS

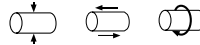

Material (designation)	Size range* mm (inch)	Temperature °C (°F)	Compressive Strength MPa (psi) ASTM/ISO Testing	Permissible Compressive Load MPa (psi)	Speed m/sec (ft/min)
AWC650 (Acetal)	6 – 381 (1/4 – 24)	-30 – 90 (-20 – 200)	55.2 (8000)	20 (2900)	3 (600)
AWC663 (Nylon)	6 – 600 (1/4 – 23.62)	-40 – 105 (-40 – 212)	90 (13050)	30 (4500)	3 (600)
AWC665 (Nylon with MoS ₂)	6 – 1320 (1/4 – 52)	-40 – 105 (-40 – 212)	96.7 (14000)	30 (4500)	3 (600)
AWC300 (Glass-Filled PTFE)	6 – 600 (24)	-35 – 120 (-30 – 250)	10.6 (1540)	3.5 (510)	5 (1000)
AWC400 (Carbon-Filled PTFE)	6 – 600 (24)	-35 – 120 (-30 – 250)	8.5 (1230)	2.5 (365)	5 (1000)
AWC500 (Bronze-Filled PTFE)	6 – 600 (24)	-35 – 120 (-30 – 250)	10.1 (1540)	4.5 (652)	5 (1000)
AWC520 (Virgin PTFE)	6 – 600 (24)	-35 – 120 (-30 – 250)	7.9 (1145)	2.5 (365)	5 (1000)
AWC630 (Unfilled PEEK)	6 – 152 (1 – 6)	-45 – 175 (-50 – 350)	138.1 (20000)	–	1 (200)
AWC635 (Glass-Filled PEEK)	6 – 152 (1 – 6)	-45 – 175 (-50 – 350)	179.5 (26000)	–	1 (200)

*Please contact your Chesterton representative for larger sizes.

Applicable standard: ISO 10766

PISTON APPLICATION

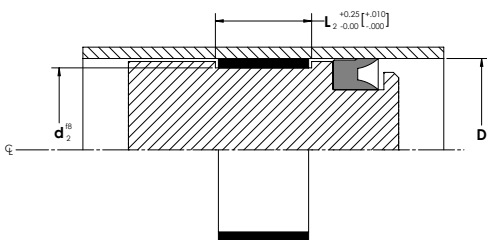

ROD APPLICATION

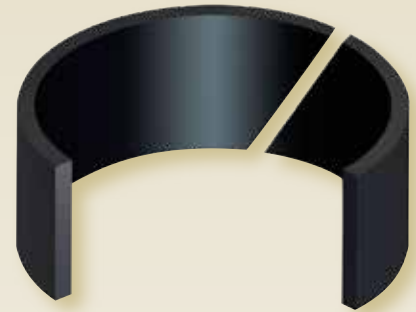
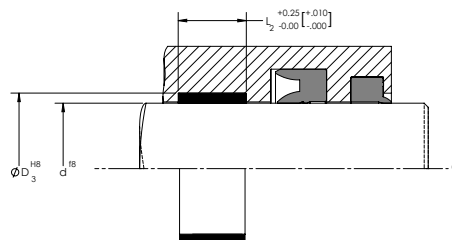

- Replaceable wear rings; cost-effective method for improving equipment performance
- Reduce radial movement; reduce probability of metal-to-metal contact while extending seal life
- Custom Wear Rings eliminate unnecessary modifications
- Reduce probability the buildup of hydrodynamic pressure, thus prolonging seal life
- Machining process allows the flexibility to create any size

PRODUCT PROFILES

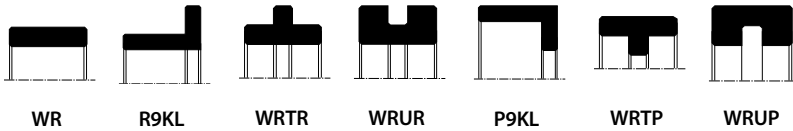

PTFE-BRONZE PV (PRESSURE-VELOCITY) CHART

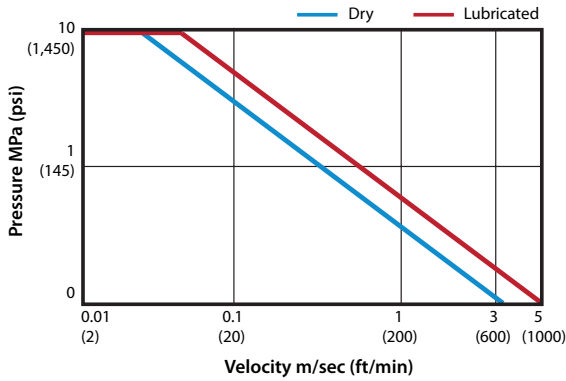

PTFE-BRONZE LOAD-TEMPERATURE CAPACITY CHART

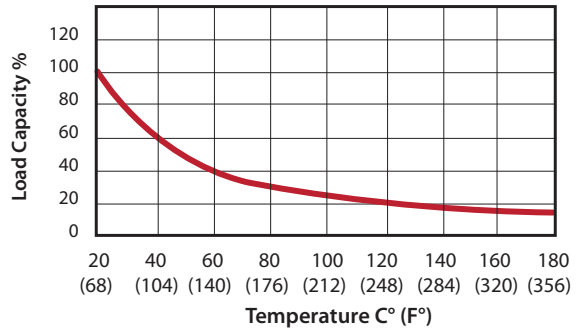

NYLON PA6 PV (PRESSURE-VELOCITY) CHART

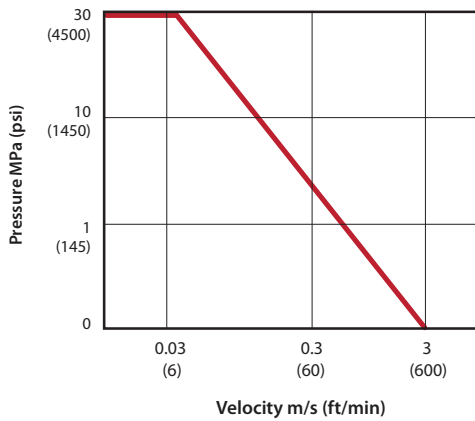

NYLON PA6 LOAD-TEMPERATURE CAPACITY CHART

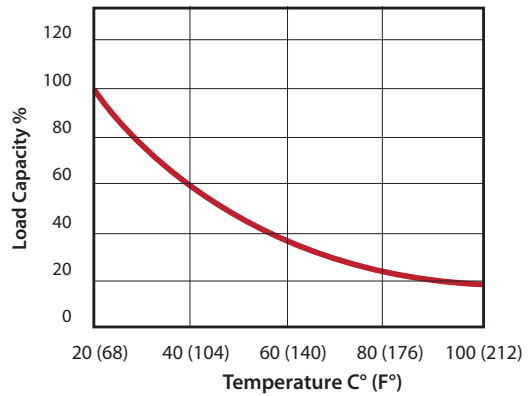

POLY-ACETAL PV (PRESSURE-VELOCITY) CHART

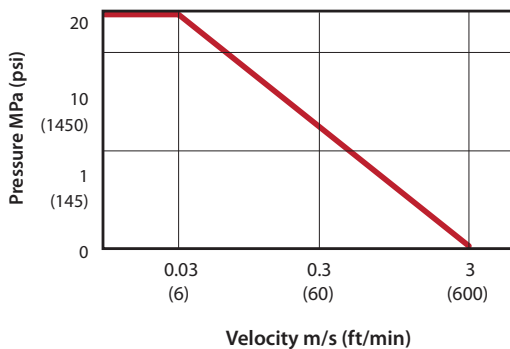

POLY-ACETAL LOAD-TEMPERATURE CAPACITY CHART

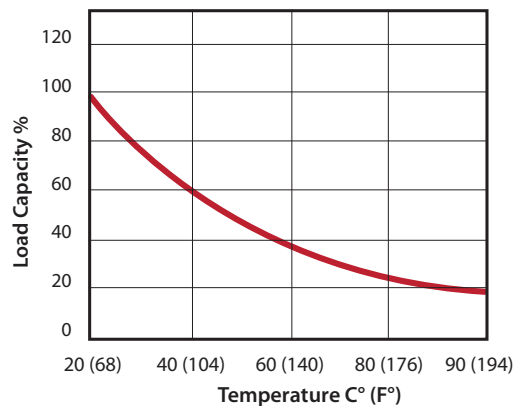

16K and 17K

Hydraulic Wear Ring Strips

High Performance, Easily Replaced Guide Rings for Large Cylinder and Forming Machines

Chesterton 16K and 17K Hydraulic Wear Rings reduce the impact of transverse force on your cylinders to achieve improved service life and reliability.

Quickly and easily replaced, 16K/17K solutions reduce costly cylinder remachining and repairs for large diameter, heavy-duty hydraulic cylinders, presses, and forming machines—even in the most difficult working conditions.

These non-metallic wear rings reduce risk of metal-to-metal scoring and reduce radial movement thus resulting in extended seal and equipment life. They also help prevent the buildup of hydrodynamic pressure in small clearances of the cylinders and assist in preventing diesel effect.

Flexible Materials for Harsh Conditions

The 16K/17K continuous coil designs are made from a combination of composite polyester resin reinforced with synthetic fibers to support high bearing capacity and heavy transverse loads. The lower Young's modulus and higher material flexibility allow the nonmetallic bearing bands to have more elastic deformation under load. The larger contact area transfers the load, causing lower surface pressure.

Prevents Fretting and Seizing

The exceptional physical properties of these wear ring strips allow for use in broad range of temperature conditions and provide excellent fluid compatibility. The built-in lubricants help reduce friction between mating surface, reduce the probability of fretting and seizing, and provide good dry-running capabilities. Chesterton's 16K and 17K bearing strips have good dimensional stability and excellent corrosion resistance.

SPECIFICATIONS

Material (designation)	Size Range* mm (inch)	Temperature °C (°F)	Compressive Strength MPa (psi) ASTM D695	Permissible Compressive Load MPa (psi)	Speed m/sec (ft/min)
AWC640 (Thermoset Polyester Resin)	300 – 1575 (12 – 62)	-40 – 121 (-40 – 250)	345 (50,000)	100 (14,500)*	1 (200)

*At 20°C (68°F)

PRODUCT PROFILES

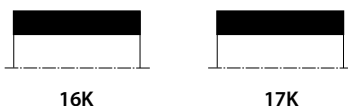

16K

17K

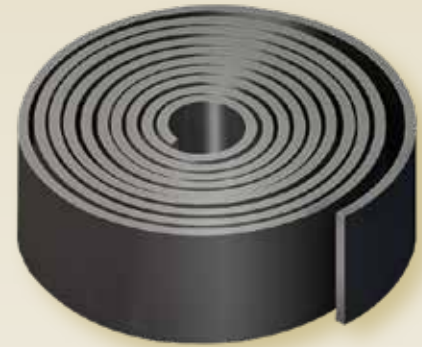

- Reduce the probability of metal-to-metal scoring to help prolong equipment life
- Reduces radial movement to extend seal life
- Contains built-in lubricants that lower the coefficient of friction between mating surfaces
- Reduces the risk of hydrodynamic pressure buildup in small clearances
- Accommodates large diameter equipment with split coil design

PISTON APPLICATION

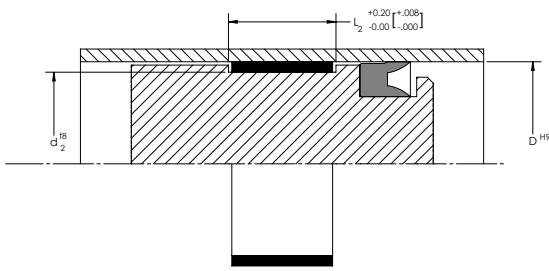

ROD APPLICATION

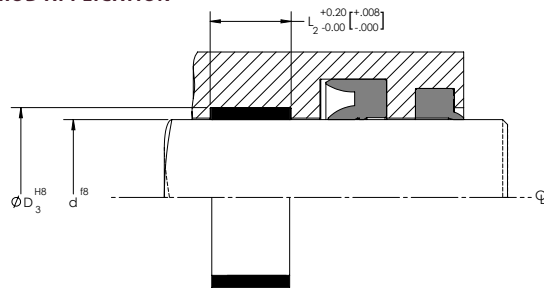

Cut to Fit

The precise manufacturing technology of the 16K and 17K Wear Ring Strips provides accurate dimensional and geometrical tolerances and improved fitting. According to industrial standards sizing, the 16K and 17K are a direct retrofit to existing bearing grooves, which eliminates equipment modification.

Universal Use in Reciprocating Applications

The split design of this product makes the installation of the cut rings easy (snap-in fitting). This allows the product to be used universally on rods, rams, or pistons in reciprocating applications for rotary or static applications.

16K METRIC DESIGN

Cross Section (S) mm	Height (L ₂) mm	Diameter Range (d/D) mm
2.50 – 4.00	15	300 – 1575
	20	300 – 1575
	25	300 – 1575
	30	300 – 1575

Applicable standards: ISO 10766

17K INCH DESIGN

Cross Section (S) inch	Height (L ₂) inch	Diameter Range (d/D) inch
0.125	0.375	12 – 62
	0.500	12 – 62
	0.625	12 – 62
	0.750	12 – 62
	1.000	12 – 62
	1.500	12 – 62
	2.000	12 – 62

AWC640 PV (PRESSURE-VELOCITY) CHART

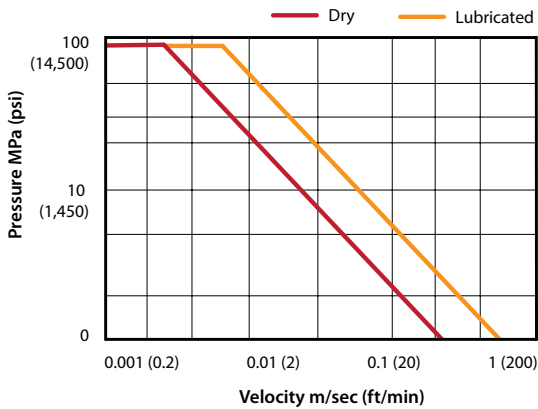

AWC640 LOAD-TEMPERATURE CAPACITY CHART

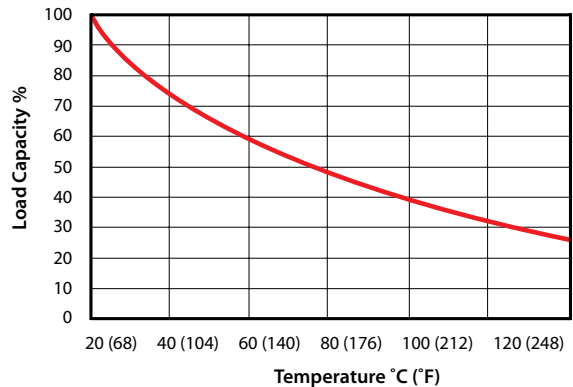

R22KN5 Split Rotary Seals

Robust Design for Slow Rotating Applications Exposed to Large Shaft Run-out

Chesterton R22KN5 Rotary Split Seals with their robust design are ideal for low-speed dynamic rotary seal applications exposed to large shaft run-out. These seals provide excellent sealing and protective solutions for heavy-duty rotating equipment even in severe application conditions thus prolonging bearing and equipment service life.

The flexible, dynamic lip of R22KN5 creates a positive, leak-free sealing and compensates considerably for shaft run-out which will improve the sealability and reliability of old, worn equipment. The optimum lip preload in combination with high performance polyurethane helps to minimize frictional drag on the seal.

The robust, static lip design provides tight sealing in the seal cavity and allows for seal installation in either tandem or back-to-back configurations thus providing the flexibility to vary seal systems according to hardware arrangement and operating conditions and demands. Further, the robust lip provides protection against seal rotation with the shaft.

The R22KN5 split configuration simplifies the installation by minimizing downtime for seal replacement and improving uptime/availability of the equipment in operation. The robust seal design minimizes stretching, bunching, or twisting during the installation which helps to reduce the probability of improper installation.

The R22KN5 is manufactured individually, using our unique machining process, which eliminates the need for tooling costs associated with new sizes. The seals are made-to-order: geometrical and dimensional design considered according to actual equipment arrangement, dimensions, and shaft run-out.

SPECIFICATIONS



Material (designation)	Size Range* mm (inch)	Temperature °C (°F)	Pressure MPa (psi)	Speed m/s (ft/min)
AWC704 (FKM)	6 – 304.8 (1/4 – 12)	-30 – 200 (-20 – 400)	16 (2320)	0.75 (150)
AWC800 (EU)	6 – 2540 (1/4 – 100)	-50 – 85 (-60 – 185)	103.5 (15000)	0.5 (100)
AWC808 (AU)	6 – 400 (1/4 – 15.75)	-20 – 85 (-4 – 185)	40 (5800)	0.25 (50)
AWC825 (EU)	6 – 2540 (1/4 – 100)	-40 – 85 (-40 – 185)	52 (7500)	0.25 (50)
AWC830 (EU)	6 – 254 (1/4 – 10)	-35 – 75 (-30 – 175)	52 (7500)	0.5 (100)
AWC860 (EU)	6 – 508.0 (1/4 – 20)	-50 – 120 (-60 – 250)	103.5 (15000)	0.5 (100)

*Please contact your Chesterton representative for larger sizes.

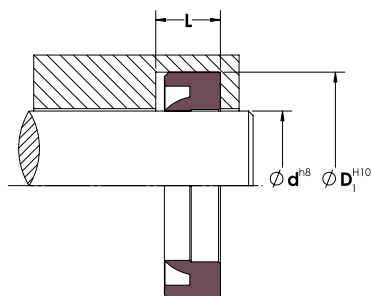

PRODUCT PROFILES



R22KN5



- Flexible dynamic lip design for large shaft run-out compensation
- Split configuration simplifies installation
- Positive rake lip design wipes contaminants away from the mating surface
- Robust static lip design allows stack set arrangement and provides stability
- Excellent abrasion-resistance; withstands demanding environments
- Manufacturing process allows flexibility to create any size

33K Split Rotary Seal

Unitized Split Seal for Bearing and Gearbox Protection

The Chesterton patent-pending 33K split design eliminates the need and associated costs for equipment disassembly and improves seal performance of conventional lip seals. This innovative, split technology minimizes penetration of external contaminants from entering the housing and provides excellent service in bearing and gear box applications.

The seal is a combination of two different material types. The unitized housing is made from abrasion-resistant thermoset polyurethane that energizes and provides easy mounting to the equipment. The sealing interface is made from high performance, filled PTFE material developed specifically for sealing applications. The seal can be installed in either direction which allows the end user to locate sealer rings away from a previously damaged shaft.

The 33K is manufactured using our unique machining process that eliminates the need for tooling costs associated with new sizes.



- Patent-pending split design eliminates the need for equipment disassembly
- Unitized design provides easy mounting to the equipment
- Proven to outperform conventional lip seals
- Flexible design, locate sealer rings away from previously fretted shaft
- Large sizes available; cost-effective solution to equipment teardown

SPECIFICATIONS



Material (combination) Adapters/ Sealer Rings	Size Range mm (inch)	Temperature °C (°F)	Speed m/s (ft/min)	Pressure bar (psi)	Recommended Use	Mating Surface (Rockwell C)
---	----------------------	---------------------	--------------------	--------------------	-----------------	-----------------------------

AWC800 Adapters (EU)

AWC100 (PTFE) Polyimide	25 – 610 (1 – 24)	85 (185)	12,7 (2,500)	0.07 (1)	Excellent dry Excellent low viscosity	≥45
AWC300 (PTFE) Moly and Glass	25 – 610 (1 – 24)	85 (185)	12,7 (2,500)	0.07 (1)	Excellent high viscosity Good dry and good in water	≥55
AWC400 (PTFE) Carbon and Graphite	25 – 610 (1 – 24)	85 (185)	12,7 (2,500)	0.07 (1)	Excellent in water Good dry and low viscosity	≥55

AWC860 Adapters (EU)

AWC100 (PTFE) Polyimide	25 – 457 (1 – 18)	121 (250)	12,7 (2,500)	0.7 (10)	Excellent dry Excellent low viscosity No water and steam	≥45
AWC300 (PTFE) Moly and Glass	25 – 457 (1 – 18)	121 (250)	12,7 (2,500)	0.07 (1)	Excellent high viscosity Good dry and good in water	≥55
AWC400 (PTFE) Carbon and Graphite	25 – 457 (1 – 18)	121 (250)	12,7 (2,500)	0.07 (1)	Excellent in water Good dry and low viscosity	≥55

Performance depends on concurrent conditions including shaft hardness, shaft surface roughness, material, lubrication, temperature, and pressure.

Applicable standard: ISO 6194-1

PRODUCT PROFILES

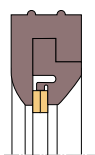

33K

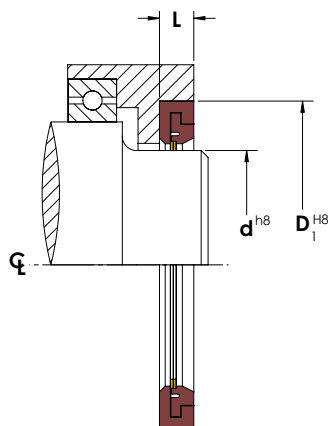

30K PTFE Lip Seals

Advanced PTFE Lip Seal for Bearing and Gearbox Protection

Chesterton 30K Lip Seals are high performance PTFE lip seals that are ideal for dynamic rotary seal applications. These seals minimize risk of penetration of external contaminants from entering the housing and provide excellent sealing service in bearing and gear box applications which prolongs bearing and equipment service life even in hostile working environments.

The unique 30K lip seal design is mechanically formed to provide optimal sealing force and is available in four distinct PTFE materials developed specifically for sealing applications. The PTFE compounds, coupled with the seal design, provide:

- Excellent fluid compatibility
- Broad range of temperature resistance (low and high temp too)
- High resistance against wear—even in cases of abrasive media or abrasive environment
- High- speed handling capability
- Low friction, reducing contact heat on lips and wear rate
- Outstanding sealing performance compared to conventional rubber lip seals

30K utilizes an O-Ring on the outer diameter of the seal which provides excellent static sealing in the seal cavity. Further, the O-Ring works as an anti-rotational device to protect the seal from rotating with the shaft.

The 30K is manufactured individually, using our unique machining process, which eliminates the need for tooling costs associated with new sizes. The 30K is offered in other unique designs based on your application requirements—whether a built-in wiper is required or space is limited. High pressure version 30KP is available (please see 30KP specification chart for further technical details).

Performance depends on concurrent conditions including shaft hardness, shaft surface roughness, material, lubrication, temperature, and pressure.

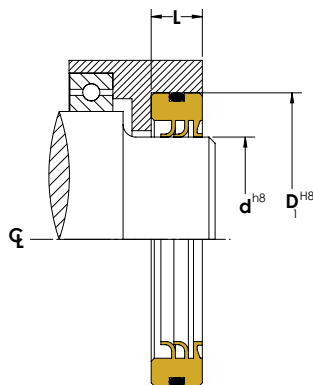

PRODUCT PROFILES

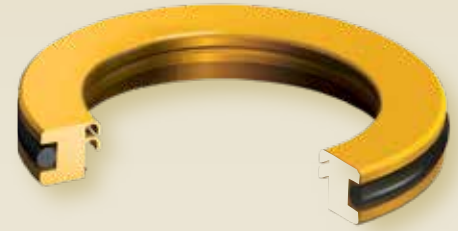
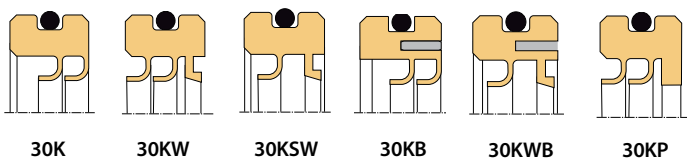

- High performance lip seals minimize risk of penetration of external contaminants
- Mechanically formed lips provide optimal sealing force to extend MTBR
- Machining process allows the flexibility to create any size without tooling cost
- Static O-Ring seal prevents rotation and allows for easy installation
- Unique materials ensure plant-wide usage

30K SPECIFICATIONS



Material (combination) Adapters/Sealer Rings	Size Range mm (inch)	Temperature °C (°F)	Speed m/s (ft/min)	Pressure MPa (psi)	Surface Finish μm (μ inch)	**Recommended Use	Mating Surface (Rockwell C)
AWC100 (PTFE) Polyimide	20 – 600 (0.787 – 23.62)	-30 – 149 (-20 – 300)	Up to 20 (4000)	0.07 MPa (10)	Dynamic 0.2 – 0.4 (8 – 16)	Excellent dry Excellent low viscosity No water and steam	≥45
AWC300 (PTFE) Molybdenum and Glass						Excellent high viscosity Good dry and good in water	≥55
AWC400 (PTFE) Carbon and Graphite					Static 0.4 – 0.8 (16 – 32)	Excellent in water Good dry and low viscosity	≥55
AWC510 (PTFE) Mineral (FDA Listed)					Excellent dry Good in water and steam No petroleum liquids	≥45	

Applicable standard: ISO 6194-1

30KP SPECIFICATIONS



Material (combination) Adapters/Sealer Rings	Shaft Size mm (inch)	Temperature °C (°F)	Speed m/s (ft/min)	Pressure MPa (psi)	Surface Finish μm (μ inch)	**Recommended Use	Mating Surface (Rockwell C)
AWC100 (PTFE) Polyimide	20 – 600 (0.787 – 23.62)	-30 – 150 (-20 – 300)	Up to 5 (984)	Up to 1 (150)	Dynamic 0.2 – 0.4 (8 – 16)	Excellent dry Excellent low viscosity (<2,000cp) Powders, oil, resins, glues, paints No water or stream	≥45
AWC300 (PTFE) Moly and glass						Excellent high viscosity (<2,000cp) Good dry, water or stream	≥55
AWC400 (PTFE) Carbon and graphite					Static 0.4 – 0.8 (16 – 32)	Excellent in water or steam Good dry and low viscosity pow- ders, asphalt, clay, slurries	≥55
AWC510 (PTFE) Mineral (FDA Listed)					Excellent dry Good in water or steam Chocolate and syrups No petroleum liquids	≥45	

Fluoroelastomer O-Rings provided (FDA listed w/AWC510) ** runout to 0,15mm (.005")

Applicable standard: ISO 6194-1

50K Mill Rotary Face Seals





High Performance Face Seals for Bearing and Gearbox Protection

Chesterton 50K face seals are high performance face seals for heavy-duty, dynamic rotary seal applications. These seals reduce the ingress of solid particles, dust, and fluids to protect the housing and bearing areas. In severe applications, where exposure to external contaminants is extremely high, the 50K is used as a secondary seal for additional protection in combination with other Chesterton rotary seals, which are in the primary seal position.

The unique design allows the 50K face seals to be used in a broad range of equipment across the heavy-duty industries. High performance elastomers create resistance to compression setting, wear, and aging. A broad range of engineered elastomers allow for use in high- and low-temperature conditions and provide excellent fluid compatibility.

The 50K is manufactured by compression molding technology that provides accurate dimensional and geometrical tolerances and improved fitting. According to industrial standards sizing, the 50K is a direct retrofit, which eliminates the need of equipment modification. The 50K is offered in different designs based on application requirements.

PRODUCT PROFILES

Series		Usage
50KA		with cross section profile that varies according to shaft diameter
50KAX		with longer lip for heavy-duty applications
50KL		with narrow axial cross section fit to compact arrangements
50KE		with special lip design for high performance sealing
50KRME		with built-in housing for a radial retention metal clamp

Typical Applications

- Back-up rolls of hot and cold rolling mills
- Work rolls of hot and cold rolling mills
- Windmill applications
- Cement plants
- Power plants
- Rotary presses
- Calander lines

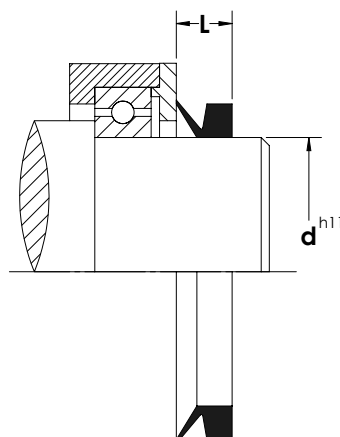

- Robust seal design stops contaminants from entering housing
- High performance elastomers ensure plant-wide usage and long service life
- Optimized lip interference for low friction
- Direct retrofit eliminates equipment modification
- Mount and stretch directly on the shaft for easy assembly

Seal Construction and Installation

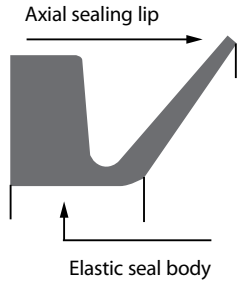

- The face seal is stretched on the shaft so that there is interference between the shaft diameter and seal inner diameter creating radial sealing and clamping force.
- The axial deformation of the conical shaped lip creates axial sealing on the counter-face.

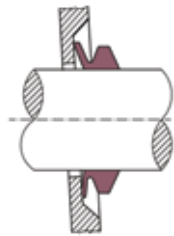
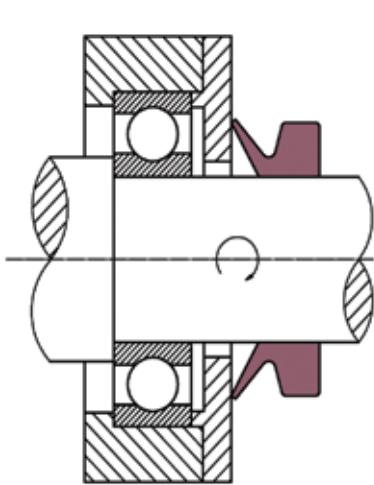

Improved lip design to compensate for shaft misalignments

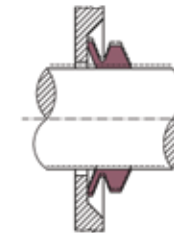

Improved lip designed to compensate for shaft run-out

SPECIFICATIONS



Material	NBR70	FKM70
Lubricating greases	-20°C – 100°C (-4°F – 212°F)	-20°C – 150°C (-4°F – 302°F)
Water	5°C – 100°C (41°F – 212°F)	5°C – 80°C (41°F – 176°F)
Surface speed m/s (ft/min)	12 m/sec (2362 ft/min)*	20 m/sec (3937 ft/min)*
Technical pressure MPa (psi)	0.03 (4.35)	0.03 (4.35)
Size range mm (inch)** shaft dia	200 – 1650 (8 – 65)	200 – 1650 (8 – 65)

*At over 8 m/s (1574 ft/min) the seal has to be supported in axial direction while over 12 m/s radial (2362 ft/min) retention is needed.

**Please contact your Chesterton representative for other sizes.

RECOMMENDED SURFACE QUALITY

Ra	Rmax
0.4 - 0.8 µm (16 - 32 µin)	1-4 µm (39 - 157 µin)

51K Mill Rotary Seals

Split Radial Seals for Bearing and Gearbox Protection





Chesterton 51K seals are high performance radial seals for heavy-duty, dynamic rotary seal applications. These seals provide long lasting sealing and superior protection against ingress of solid particles, dust, and fluids and protect bearing houses and gearboxes across the heavy industries, even in the most hostile working environments.

High performance elastomers create resistance to compression setting, wear, and aging. A broad range of engineered elastomers allows use in high- and low-temperature conditions and provides excellent fluid compatibility.

The 51K is manufactured by compression molding technology that provides accurate dimensional and geometrical tolerances and improved fitting. The seal body is equipped with a strong, flexible fabric back for tight fitting within the seal cavity. A helical garter spring maintains the seal lip contact and sealing force on the shaft.

According to industrial standards sizing, the 51K is a direct retrofit, which eliminates the need for equipment modification. The 51K is offered in different designs based on application requirements.

PRODUCT PROFILES

Series	Usage
51K 	with standard style in solid and split form
51KW 	with additional dust lip
51KHP 	with special lip profile to withstand high pressures up to 0,4 MPa (4 bar) – solid only
51KL 	with additional circumferential groove for lubrication

Typical Applications

- Gear drives
- Back-up rolls in hot and cold mills
- Work rolls in hot and cold mills
- Pulp and paper industry
- Pumps
- Propeller shafts
- Wind turbine main bearings
- Rotary applications in cement plants

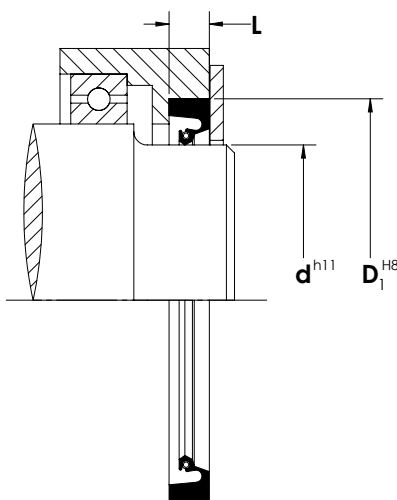

- Long lasting sealing and superior protection against ingress of foreign materials
- High performance elastomers ensure plant-wide usage and long service life
- Unique lip design combined with autolubricated elastomer offers low friction
- Direct retrofit eliminates equipment modification
- Split versions are available for easy assembly

Seal Construction

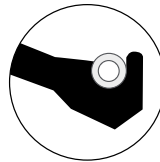
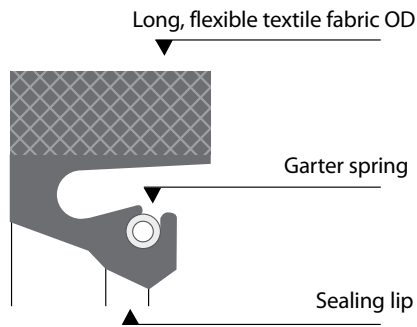

Traditional open garter spring groove design

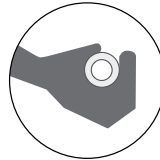

Improved garter spring groove design from Chesterton for safe installation

INSTALLATION INFORMATION

Parameters	Recommended Values
Shaft hardness	40 – 50 HRC
Shaft surface finish	Ra = 0.3 – 0.5 µm (12 – 20 µin) and Rmax 1 – 2 µm (40 – 80 µin) plunge ground
Shaft tolerance	h11
Housing tolerances	H8
Shaft misalignment	Depending on the surface speed 1.5 mm (0.06 in) should not be exceeded

Mounting

- The Chesterton 51K Series is always used with a retaining plate
- The retaining plate creates an axial preload that adds to the static sealability of the seal
- The plate should be sufficiently dimensioned to avoid distortion when bolting up
- To ease mounting of the seal ring make sure the housing has a lead-in chamfer

SPECIFICATIONS



Elastomers	NBR80+PTFE	HNBR70	FKM70+PTFE
OD Fabric	Textile + NBR	Textile + HNBR	Textile + FKM
Materials of garter spring	AISI 302 – 316	AISI 302 – 316	AISI 302 – 316
Lubricating greases	-20°C – 100°C (-4°F – 212°F)	-30°C – 150°C (-22°F – 302°F)	-20°C – 200°C (-4°F – 392°F)
Mineral oils	-20°C – 100°C (-4°F – 212°F)	-30°C – 150°C (-22°F – 302°F)	-20°C – 200°C (-4°F – 392°F)
Water	5°C – 100°C (41°F – 212°F)	5°C – 150°C (41°F – 302°F)	5°C – 100°C (41°F – 212°F)
Surface speed m/s (ft/min)	15 (2952 ft/min)	20 (3937 ft/min)	25 (4921 ft/min)
Technical pressure MPa (psi) 51K, 51KW, 51KL Solid	0.05 (7.25)	0.05 (7.25)	0.05 (7.25)
Technical pressure MPa (psi) 51K, 51KW, 51KL Split	No pressure can be applied	No pressure can be applied	No pressure can be applied
Technical pressure MPa (psi) 51KHP Solid	0.4 (58)	0.4 (58)	0.4 (58)
Size range mm (inch)** Seal OD	300 – 1200 (12 – 47)	300 – 1200 (12 – 47)	300 – 1200 (12 – 47)

**Please contact your Chesterton representative for other sizes.

52K Mill Rotary Seals

Radial Seals for Bearing and Gearbox Protection



Chesterton 52K seals are high performance radial seals for heavy-duty, dynamic rotary seal applications. These seals provide long lasting sealing and superior protection against ingress of solid particles, dust, and fluids and protect bearing houses and gearboxes across the heavy industries, even in the most hostile working environments.

High performance elastomers provide resistance to compression setting, wear, and aging. A broad range of engineered elastomers allows use in high- and low-temperature conditions and provides excellent fluid compatibility.

The 52K is manufactured by compression molding technology that provides accurate dimensional and geometrical tolerances. The unique design with a flexible stiffener ring ensures improved fitting in the seal cavity and allows installation in stuffing boxes without end covers. A helical garter spring maintains the seal lip contact and sealing force on the shaft.

According to industrial standards sizing, the 52K is a direct retrofit, which eliminates the need for equipment modification. The 52K is offered in different designs based on application requirements.

PRODUCT PROFILES

Series		Usage
52K		with standard style
52KW		with additional dust lip
52KHP		with special lip profile to withstand high pressures up to 0,4 MPa (4 bar)

Typical Applications

- Gear drives
- Back-up rolls in hot and cold mills
- Work rolls in hot and cold mills
- Pulp and paper industry
- Pumps
- Windmill applications
- Rotary applications in cement plants

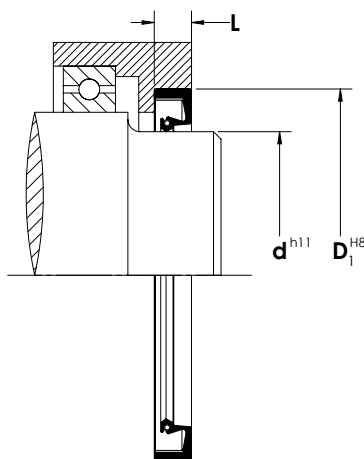

- Long lasting sealing and superior protection against ingress of foreign materials
- High performance elastomers ensure plant-wide usage and long service life
- Unique lip design combined with autolubricated elastomer for low friction
- Direct retrofit eliminates equipment modification
- Unique design with flexible stiffener ring ensures improved fitting

Seal Construction

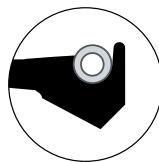
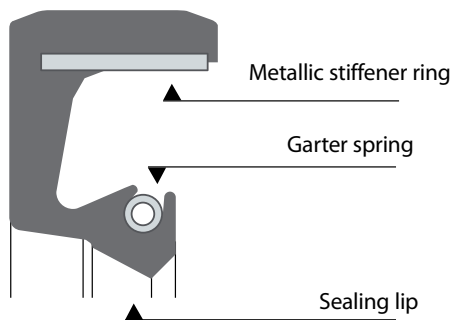

Traditional open garter spring groove design

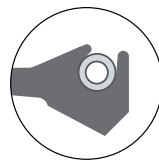

Improved garter spring groove design from Chesterton for safe installation

INSTALLATION INFORMATION

Parameters	Recommended Values
Shaft hardness	40 – 50 HRC
Shaft surface finish	Ra = 0.3 – 0.5 µm (12 – 20 µin) and Rmax 1 – 2 µm (40 – 80 µin) plunge ground
Shaft tolerance	h11
Housing tolerances	H8
Shaft misalignment	Depending on the surface speed 1.5 mm (0.06 in) should not be exceeded

Mounting

- The Chesterton 52K Series can be used without a retaining plate
- To ease mounting of the seal ring make sure the housing has a lead-in chamfer

SPECIFICATIONS



Elastomers	NBR80+PTFE	FKM70+PTFE
Material of metal case	C72 tempered	C72 tempered
Material of garter spring*	AISI 302 – 316	AISI 302 – 316
Lubricating greases	-30°C – 100°C (-22°F – 212°F)	-20°C – 200°C (-4°F – 392°F)
Mineral oils	-30°C – 100°C (-22°F – 212°F)	-20°C – 200°C (-4°F – 392°F)
Water	5°C – 100°C (41°F – 212°F)	5°C – 100°C (41°F – 212°F)
Surface speed m/s (ft/min)	15 (2952)	25 (4921)
Technical pressure MPa (psi)	0.05 (7.25)	0.05 (7.25)
Size range mm (inch)** Seal OD	300 – 1200 (12 – 47)	300 – 1200 (12 – 47)

*On request PVC cover to avoid dust entering garter spring.

**Please contact your Chesterton representative for other sizes.

53K Premium Mill Rotary Seals

High Performance Seals for Bearing and Gearbox Protection







Chesterton 53K seals are high performance radial seals for heavy-duty, dynamic rotary seal applications. These seals provide long lasting sealing and protective solutions that withstand high speed and large misalignment of shafts and rolls in heavy industry.

The 53K represents advanced technology: combined finger and garter springs in combination with high performance elastomers, which outlast the conventional radial oil seals in the most difficult applications.

The outer metal case of 53K is cold pressed. The elastomer part is manufactured by compression molding technology that is vulcanized to the metal case which provides very tight dimensional and geometrical tolerances. The unique design with a flat, outer metal case ensures improved fitting in the seal cavity and an improved centric position. Additionally, this design allows installation in stuffing boxes without end covers.

According to industrial standards sizing, the 53K is a direct retrofit, which eliminates the need for equipment modification. The 53K is offered in different designs based on application requirements.

PRODUCT PROFILES

Series	Usage
53K 	with standard style with garter-finger spring system
53KW 	with additional dust lip
53KHP 	with special, robust lip profile to withstand high pressures up to 0,1 MPa (1 bar)
53KL 	with special, optimized lip interference for high-speed applications
53KLHS 	with special, low lip interference for ultra high-speed applications
53KLPT 	with integrated (vulcanized) PTFE lip tip

Typical Applications

- High-speed gear drives
- High-speed back-up rolls in cold mills
- Work rolls in hot and cold mills
- Aluminum foil mills
- Paper machines
- Cement plants
- Power plants



- Unique lip preload system with highly flexible garter-finger spring combination
- Large shaft run-out compensation capability
- Unique lip design combined with autolubricated elastomer offer low friction and ultra high surface speed
- Direct retrofit eliminates equipment modification
- High performance elastomers ensure plant-wide usage and long service life

Seal Construction

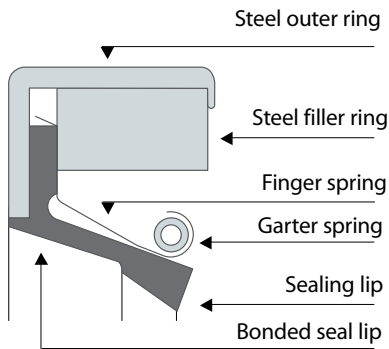

- The service life and performance of the seal are largely dependent upon the preload of the seal lip on the shaft. In this respect the 53K design offers a significant advantage over conventional garter spring seal types as a result of its highly elastic garter-finger spring combination.
- Shaft misalignment (shaft deflection, bearing clearance, out of round and run-out) creates changes to the lip preload that can in conventional seals compromise either or both lip tip sealing integrity and seal life.
- The finger-garter spring combination in 53K largely eliminates the effect of external forces causing changes in lip tip preload and therefore is more likely to maintain the fluid film underneath the lip the condition of which has the greatest effect on seal service life and performance.

SHAFT AND HOUSING TOLERANCES

Shaft Ø (mm)	Housing Bore Ø (mm)
<= 100 +/- 0,08 (<= 4 +/- 0.00315)	<= 76 +/- 0,025 (<= 2,99 +/- 0.001)
101 – 150 +/- 0,1 (4,01 – 5.9 +/- 0.004)	77 – 150 +/- 0,04 (3 – 5.9 +/- 0.0016)
151 – 250 +/- 0,13 (5,91 – 9,842 +/- 0.005)	151 – 255 +/- 0,05 (5.91 – 10 +/- 0.002)
>= 250 +/- 0,25 (9,85 +/- 0.01)	256 – 510 + 0,05/-0,10 (10.1 – 20 +0.002/-0.004)
	511 – 1.015 + 0,05/-0,15 (20,1 – 40 +0.002/0.006)
	>1.015 +0,05/-0,25 (40,1 +0.002/-0.01)

SHAFT HARDNESS AND SURFACE FINISH TOLERANCES

Speed (m/sec)	Max Roughness		Hardness (HRC)
	Ra (µm)	Rmax (µm)	
<= 10 (1968)	0.5 – 0.6 (20 – 24)	2 – 3 (80 – 120)	30
11 – 16 (2165 – 3150)	0.3 – 0.5 (12 – 20)	1 – 2 (40 – 80)	40
>16 (3150)	0.2 – 0.3 (8 – 12)	0.8 – 1 (32 – 40)	50

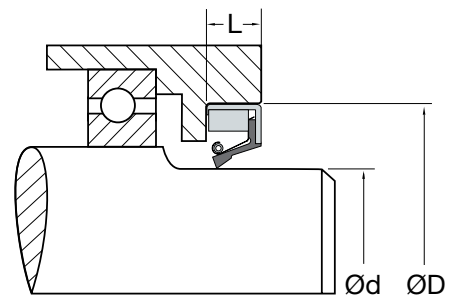

SPECIFICATIONS

Elastomers	NBR80+PTFE	FKM70+PTFE
Material of metal case	FePO ₃	FePO ₃
Material of steel filler ring	Fe37	Fe37
Material of spring carrier	AISI 301	AISI 301
Materials of garter spring	AISI 316	AISI 316
Lubricating greases	-20°C – 100°C (-4°F – 212°F)	-20°C – 200°C (-4°F – 392°F)
Mineral oils	-20°C – 100°C (-4°F – 212°F)	-20°C – 200°C (-4°F – 392°F)
Surface speed m/s (ft/min)	25 (4921)	25 – 35 (4921 – 6889)
Technical pressure MPa (psi) 53K, 53KW, 53KL, 53KLHS 53KLPT	0.05 (7.25)	0.05 (7.25)
Technical pressure MPa (psi) 53KHP	0.1 (14.5)	0.1 (14.5)
Size range mm (inch)** Seal OD	300 – 1200 (12 – 47)	300 – 1200 (12 – 47)

*Please contact your Chesterton representative for other sizes.

Kaplan Turbine Runner Blade Trunnion Split Seal

High Performance, Split Lip Seal for Heavy-Duty Rotary and Oscillating Applications

Chesterton Kaplan Runner Blade Trunnion Split Seals create a positive, leak-free sealing system that will improve sealing and reliability of runner blades to meet environmental control requirements. These seals provide long lasting sealing and protective solutions for Kaplan turbine runners that withstand severe application conditions.

The Chesterton Kaplan Runner Blade Trunnion Split Seal represents advanced seal design technology combined with high performance polymer materials which outlast conventional sealing systems even in very difficult applications.

The high performance Chesterton seal material, AWC800 (95 Shore A) thermoset polymer (EU), offers superior memory, excellent abrasion resistance, and improved durability. The polymer provides a built-in molybdenum disulfide lubricant to minimize frictional drag. The material's superior memory enables the seal to automatically adjust and compensate for radial cross-sectional variances commonly associated with blade droop.

This innovative Chesterton seal has a positive lip design that resists the rotary motion that could pull the splits apart and it uses load pressure to join the cut ends. During blade positioning, Chesterton's seal maintains load pressure and also allows for rotary shaft movement with minimal frictional drag. When performance is measured by cost containment and efficiency, downtime can have serious consequences. Downtime is minimized with this seal because the removal of the blade is not required. In addition, only two seals need to be installed in back-to-back configuration rather than a full stacked set.

SPECIFICATIONS



Material (designation)	Size Range mm (inch)	Temperature	Pressure MPa (psi)	Speed m/s (ft/min)
AWC800 (EU)	6 – 2540 (1/4 – 100)	-50 – 85 (-60 – 185)	2(300)	0.5(100)

PRODUCT PROFILES

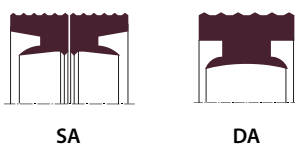

SA



DA



- Superior performance improves turbine efficiency
- Extends equipment life thus improving turbine effectiveness
- Minimize the risk of downstream leakage which makes it environmentally friendly
- Effectively seals blade droop and associated issues
- Split design is field serviceable and minimizes downtime
- Minimize oil loss and associated costs
- Direct retrofit eliminates equipment modifications

Features

- Downtime is minimized: removal of the blade is not required.
- Only two seals need to be installed (rather than a full stacked set).
- The seal maintains load pressure during blade positioning.
- Internal seal lubrication allows for rotary shaft movement with almost no frictional drag on the seal.
- Blade and seal maintain positions for maximum sealing.
- Made to order: geometry and dimensions of the seal are according to actual hardware arrangement and dimensions.
- Back-to-back configuration: keeps contaminants out of hub, keeps oil in.
- Robust seal design: prevents excessive stretching, bunching, or twisting of the seal rings during installation.
- Multiple sealing points on static side of the seal: in case of corroded seal cavity surface, the multiple sealing points can provide tighter sealing.

BACK-TO-BACK CONFIGURATION

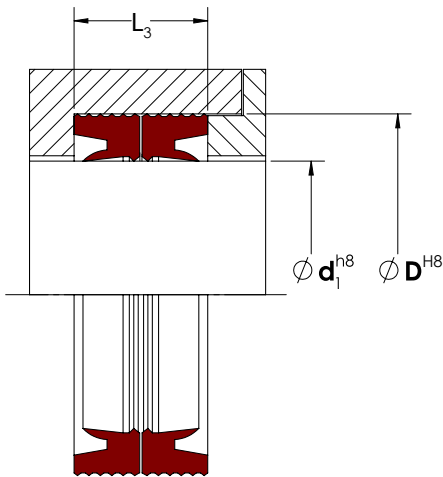

DOUBLE-ACTING, SINGLE RING CONFIGURATION

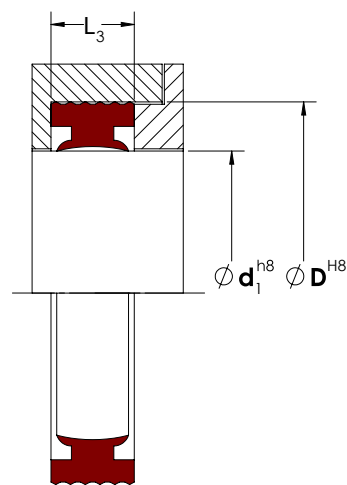

Polymer Labyrinth Seal

Unitized, Non-Contacting Seal for Bearing Protection

The Chesterton patent-pending Polymer Labyrinth Seal (PLS) is a non-contact bearing seal designed to provide protection for pumps, gearboxes, and other rotating equipment in splash applications. The unique design eliminates fretting caused by conventional lip seals and helps to increase bearing and gearbox life by extending the mean time between equipment repairs (MTBR).

This unitized labyrinth seal uses Chesterton’s exclusive polymer to create a non-contacting 3-piece seal design that includes a rotor, a stator, and a built-in valve with no wearing parts. While in operation, centrifugal force and gravity enable the lubricant to contain within the labyrinth and flows back into the bearing housing while outside contaminants are excluded and redirected back to the atmosphere.

The unique design also incorporates a built-in valve that is activated by shaft rotation which engages during shutdown periods to create a positive seal during idle time and blocks ingress of external contaminants from entering the housing.

Chesterton’s material technology is manufactured from an advanced, durable, maintenance-friendly thermoset polymer compatible with common bearing and gear oils that offers a cost-effective alternative solution to other material options. Each seal is custom manufactured to the exact equipment size needed to maximize performance.



- High performance, non-contact design eliminates fretting caused by lip seals
- Keeps lubrication in and seals out external contamination
- Unitized design and durable non-sparking material provide easy, reliable installation
- Available in a variety of configurations to meet plant-wide equipment needs
- Same-day shipment availability, minimizing downtime and associated costs
- Standard sizes available for popular equipment, custom sizes available upon request
- IP56 (third party certification) resistant to dust and water

SPECIFICATIONS



Material (designation)	Size Range* mm (inch)	Temperature °C (°F)	Speed* m/s (ft/min)	Eccentricity mm (inch)
AWC800 (EU)	25 – 500.8 (1 – 20)	-40 – 93 (-40 – 200)	30.5 (6000)	0.75 (0.030)

*Contact engineering for speed, beyond these limits

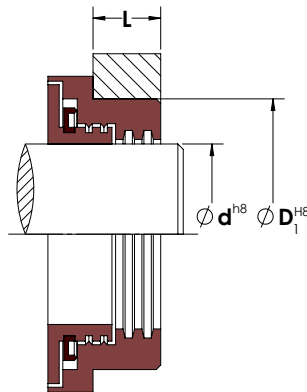

PRODUCT PROFILES



PLS1



PLS2

30KC Cartridge Multi Lip Seal

Cartridge Design for Sealing Powders and Viscous Fluids

Chesterton 30KC polymer cartridge seals are used in dynamic rotary seal applications. This cartridge design uses high performance, filled PTFE materials proven to withstand the high shear rates, frictional heat, and abrasives common when either pumping high-viscosity products or moving powders.

The 30KC is designed with an inboard sealing element, an outboard sealing element, and built-in flushing ports. The inboard lip seals process fluid, the outboard lips seal barrier fluid, while the flush port allows for flushing. The versatile cartridge design is extremely tough and able to withstand adhesion between the sealing surfaces and shaft due to reacted material and dry running capabilities.

The 30KC high performance, filled PTFE compounds are coupled with the unique seal design to provide excellent fluid compatibility, temperature resistance and reduced frictional force thus improving performance and reliability in demanding applications.

All engineered cartridges are custom manufactured to equipment dimensions thus eliminating the need for equipment modifications.



- Outperforms conventional packing and lip seal sets when sealing high-viscosity fluids and dry powders
- Decreases downtime; easy-to-install versatile cartridge design
- Improves performance of compression packing; distinct PTFE materials
- Custom-designed cartridges made to equipment dimensions

SPECIFICATIONS



Material* (combination) Adapters/ Sealer Rings	Shaft Size mm (inch)	Temperature °C (°F)	Speed m/s (ft/min)	Pressure MPa (psi)	Mating Surface (Rockwell C)	Surface Finish μm (μinch)	**Recommended use
AWC100 (PTFE) Polyimide	25 – 200 (1.000 – 7.7875)	-30 – 150 (-20 – 300)	Up to 5 (984)	Up to 1 (150)	45		Excellent dry excellent low viscosity (<2,000cp) powders, oil, resins, glues, paints no water or steam
AWC300 (PTFE) Moly and Glass					55	Dynamic 0.2 – 0.4 (8 – 16)	Excellent high-viscosity (<2,000cp) Good dry, water or steam
AWC400 (PTFE) Carbon and Graphite					55	Static 0.4 – 0.8 (16 – 32)	Excellent in water or steam Good dry and low viscosity powders, asphalt, clay, slurries
AWC510 (PTFE) Mineral (FDA listed)					45		Excellent dry Good in water or steam chocolate and syrups no petroleum liquids

*Fluoroelastomer O-Rings provided (FDA listed w/AWC510)

**Run-out to 0,15mm (.005")

Applicable standards: ISO 3069

PRODUCT PROFILES

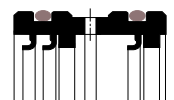

30KC

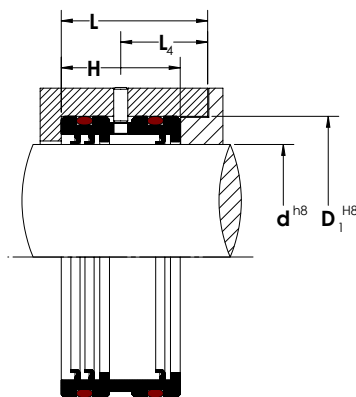

14K Restriction Bushings

Robust, Restriction Bushing for Rotary Equipment

Chesterton 14K Restriction Bushings are used in rotary equipment to form a barrier between the sealing device in the stuffing box or the pump impeller housing and the fluid in the mixing tank. The restriction that is produced reduces flush requirements and helps to prevent suspended abrasive particles from entering the stuffing box area thus prolonging the service life of installed packing sets or mechanical seals.

The 14K's tapered lip design conforms to equipment eccentricities to minimize the annular gap formed around the rotating shafts, thereby creating the smallest possible free flow area for controlling flush flow rates. A secondary beneficial effect of increasing pressure drop with the 14K is that the flush around the shaft becomes very uniform, which is critical in preventing particulates from entering the stuffing box envelope. The dynamic lip acts as a check valve when flush is shut-off.

The solid 14K reduces the number of packing rings required in the stuffing box thus helping to reduce frictional force. Further, it helps to keep the lantern ring in its position and maintain the optimum flush rate.

The 14K is manufactured from superior abrasion-resistant polymers, while the PTFE compound offers broad media compatibility with high-temperature capability.

The 14K restriction bushings are manufactured using a machining process which allows the flexibility to create any size, based on equipment dimensions. Each bushing is individually manufactured and provides excellent performance in pumps, agitators, mixers, refiners, and other equipment.

SPECIFICATIONS



Material (designation)	Size Range* mm (inch)	Temperature °C (°F)	pH
AWC520 (PTFE)	25 – 355 (1 to 14)	Up to 200 (400)	0 – 14
AWC800 (EU)	25 – 355 (1 to 14)	Up to 85 (185)	4 – 10

*Contact engineering for speed, beyond these limits

Applicable standard: ISO3069

Flow rates — approximated for water by the following formulas

Flow rate, liter/min = $([0.115 \times \Delta \text{ pressure, bar}] + [0.064]) \times \text{shaft diameter, mm}$

Flow rate, gallon/min = $([0.053 \times \Delta \text{ pressure, psi}] + [0.43]) \times \text{shaft diameter, inch}$

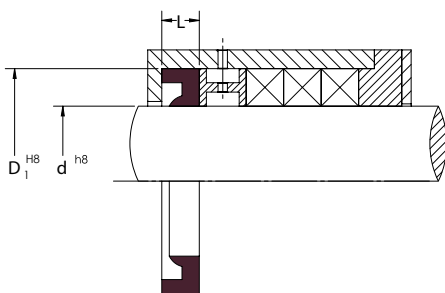

PRODUCT PROFILES

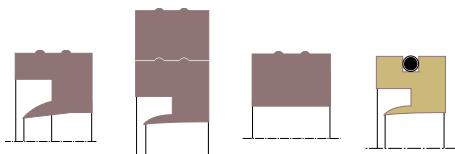

R14K

R14K2P

R14KRBS

R14KPF

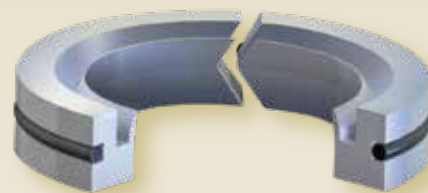

- Split design simplifies installation
- Minimize risk of entering particles into stuffing box; extend packing and seal life
- Tapered lip design controls fluid bypass and helps increase pumps efficiency
- Dual materials available; plant-wide usage
- Reduces the number of packing rings required which reduces frictional force
- Designed for pumps of all types including agitators, mixers, and refiners

14KL Lantern Rings

Robust, Restriction Bushing for Rotary Equipment

Chesterton 14KL Lantern Rings are used in rotating equipment to improve lubrication as well as cooling for packing rings and lip seals by distributing the liquid uniformly around the circumference of the shaft, where the external lubrication is utilized. A further function of the Lantern Rings is to keep abrasives and chemicals flushed.

The 14KL greatly improves the service life of compression packing in pump, mixer, or rotary airlock stuffing box area. Lantern rings are also used in bearing protection applications with great results, where they help to duct lubricant and provide better lubrication for the rotary lip seal.

14KL incorporates multiple radial holes to provide proper and uniform fluid distribution. Lead-in chamfers on the OD of the rings make for easy installation.

The 14KL is manufactured from superior abrasion-resistant polymers, while PTFE compound offers broad media compatibility with high- temperature capability.

The 14KL Lanter Rings are manufactured using a machining process which allows the flexibility to create any size, based on equipment dimensions. Each bushing is individually manufactured and provides excellent performance in pumps, agitators, mixers, refiners, and other equipment. 14KL is available in solid and split or half-ring versions for ease of installation and maintenance.



- Improved lubrication and cooling effect helps to extend service life of packing and lip seals
- Keeps abrasives and chemicals flushed
- Split or half-ring design for ease of installation
- Different material options for plant-wide usage
- Designed for pumps of all types including agitators, mixers, and refiners

SPECIFICATIONS



Material (designation)	Outer Diameter Size Range* mm (inch)	Temperature °C (°F)	pH Range
AWC800 (EU)	38.1 – 660.4 (1.5 – 26)	Up to 85 (185)	4 – 10
AWC808 (AU)	38.1 – 400 (1.5 – 15.75)	Up to 85 (185)	4 – 10
AWC860 (EU)	38.1 – 660.4 (1.5 – 26)	Up to 120 (250)	4 – 10
AWC300 PTFE (Glass-Filled)	38.1 – 381 (1.5 – 15)	Up to 200 (400)	0 – 14
AWC510 PTFE (Polyimide-Filled)	38.1 – 381 (1.5 – 15)	Up to 200 (400)	0 – 14
AWC520 PTFE (Virgin)	38.1 – 381 (1.5 – 15)	Up to 200 (400)	0 – 14

*Contact engineering for speed, beyond these limits
Applicable standard: ISO 3069

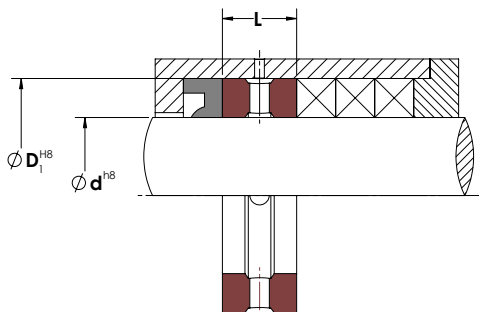

PRODUCT PROFILES



14KL

100 Series

Cantilever Spring Design

Cantilever Spring Energized Seals, Highly Dynamic Applications

Cantilever spring energized seals are primarily used in highly dynamic applications for rotary and reciprocating equipment, but they can be used in static applications too, when higher deflection springs are needed. The improved spring and seal deflection capability can be required due to excessive expansion or contraction or wide hardware tolerance.

100 Series incorporates a U-shaped seal jacket with a high performance, stainless steel V-shaped cantilever spring to apply positive sealing force to the mating surface.

100 Series design utilizes an asymmetric seal profile, where the dynamic lip has a robust profile in combination with a front angle, providing excellent leakage control and good scraping effect in case of highly viscous medias. The V-shaped cantilever spring design provides the spring tension at the leading edge of the seal only which helps to optimize lip load and minimize frictional force.

Seal jackets are made from high performance fluoroplastic compounds and engineered plastics that provide low coefficient of friction, high abrasion resistance, dimensional stability, and outstanding resistance to most fluids, chemicals, and gases.

This is the most popular series for spring energized seal designs due to its unique attributes, which help to maximize seal and hardware life.

The 100 Series is available in different unique jacket materials to address a broad range of applications.

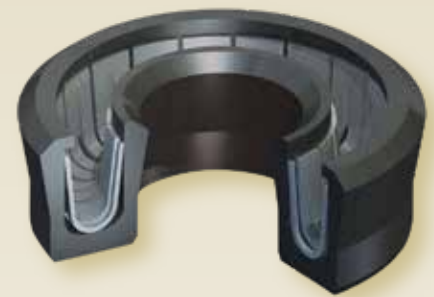

- Highly dynamic and static applications; plant-wide usage
- Unidirectional designs; available as rod, piston, flange, or static seals
- Single-point profile yields high sealability while minimizing frictional force
- All seals are made-to-order; no equipment modifications required
- Custom designs and materials available upon request

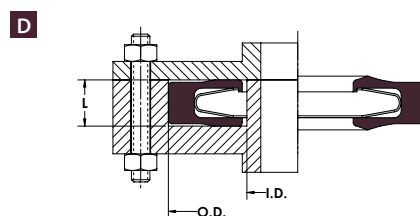
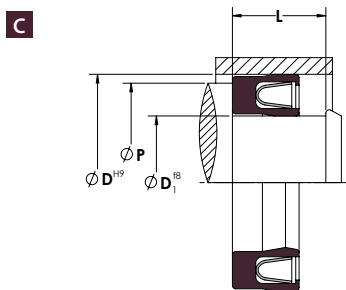
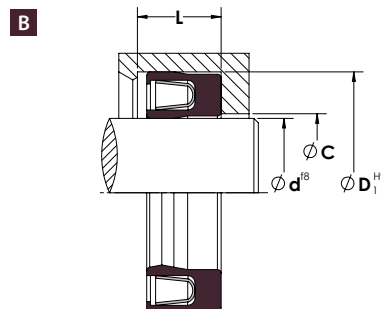
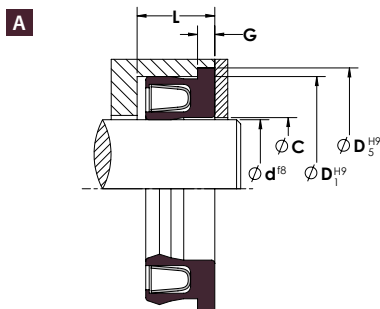



SPECIFICATIONS

Material (designation)	Size Range* mm (inch)	Temperature °C (°F)
AWC400 (PTFE) Carbon and Graphite	1.2 – 2032 (0.050 – 80)	-156 – 204 (-250 – 400)
AWC630 PEEK	1.2 – 254 (0.050 – 10)	-73 – 204 (-100 – 400)
AWC610 UHMWPE	1.2 – 2032+ (0.050 – 80+)	-253 – 82 (-425 – 180)

*Please contact your Chesterton representative for larger sizes.

PRODUCT PROFILES



EPS100



EPS101



EPS103



EPS105



EPS107



EPS109



EPS115



EPS119



EPS130



EPS139

200 Series

Elliptical Coil Spring Design

Elliptical Coil Spring Energized Seals with Constant Lip Load

Elliptical coil spring energized seals are commonly used in rotary, reciprocating, and static applications where constant lip load or constant friction for low-pressure applications is needed. The elliptical coil spring provides an almost constant load on seal lips independent of hardware tolerances, eccentricity, and seal wear.

200 Series incorporates U-shaped seal jacket with a high performance, stainless steel elliptical coil spring with high spring loading, what provides excellent sealing at zero or low system pressure too, even in case of fluid and gas applications.

Seal jackets are made from high performance fluoroplastic compounds and engineered plastics that provide low coefficient of friction, high abrasion resistance, dimensional stability, and outstanding resistance to most fluids, chemicals, and gases and a resistance to aging.

The 200 Series is available in three unique jacket materials to address a broad range of applications. Each seal jacket is used in combination with a high performance, stainless steel elliptical coil spring to apply positive sealing force to the mating surface.



- Unidirectional design accommodates excessive tolerances or misalignment
- Elliptical coil spring design; high load vs. deflection
- Miniature profiles accommodate small diameters
- All seals are made-to-order; no equipment modifications required
- Custom designs and materials available upon request

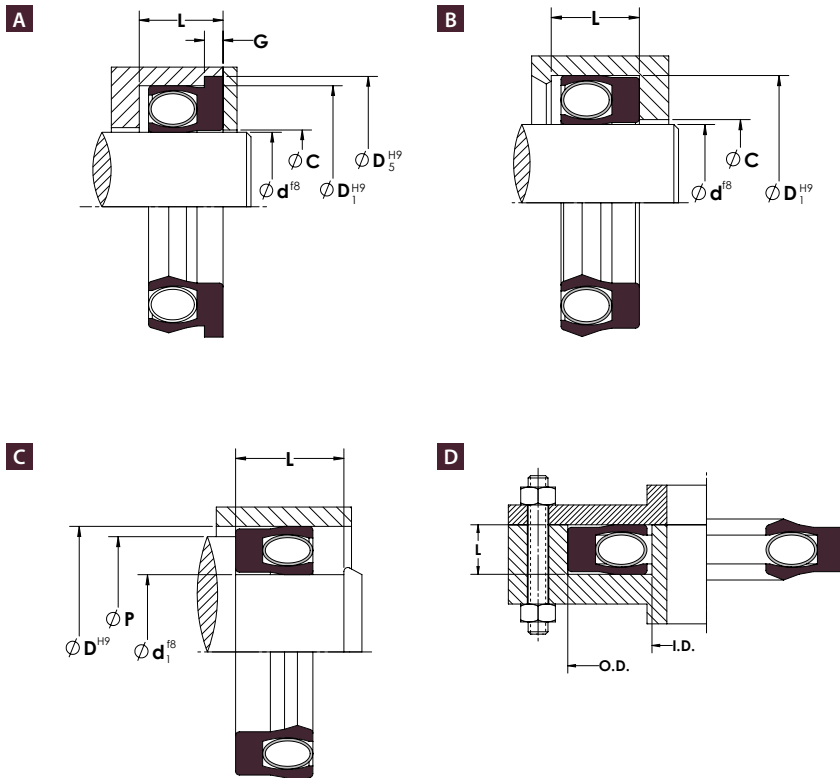



SPECIFICATIONS

Material (designation)	Size Range* mm (inch)	Temperature °C (°F)
AWC400 (PTFE) Carbon and Graphite	1.2 – 2032 (0.050 – 80)	-156 – 204 (-250 – 400)
AWC630 PEEK	1.2 – 254 (0.050 – 10)	-73 – 204 (-100 – 400)
AWC610 UHMWPE	1.2 – 2032+ (0.050 – 80+)	-253 – 82 (-425 – 180)

*Please contact your Chesterton representative for larger sizes.

PRODUCT PROFILES



EPS200



EPS204



EPS205

300 Series

Helical Wound Spring Design

Helical Wound Spring Energized Seals for Slow Speed and Static Applications

Helical wound spring energized seals are primarily used in static applications, slow speeds, extremely low temperatures, and/or infrequent dynamic conditions when friction and wear are secondary concerns. The spring design has excellent loading capabilities with minimal deflection.

300 Series incorporates a U-shaped seal jacket with a high performance, stainless steel helical wound spring which produces very high load versus lip deflection. The helical wound spring provides evenly distributed load on each individual band of the spring. As the gaps are very small between the coils, the spring creates near continuous load around the interference of the seal, thus significantly reducing potential leak paths. That is why 300 Series seals are well-suited for zero or low system pressure, vacuum, and cryogenic applications.

Seal jackets are made from high performance fluoroplastic compounds and engineered plastics that provide high abrasion resistance, dimensional stability, and outstanding resistance to most fluids, chemicals, and gases and a resistance to aging.

The 300 Series is available in three unique jacket materials to address a broad range of applications. Each seal jacket is used in combination with a high performance, stainless steel elliptical coil spring to apply positive sealing force to the mating surface.

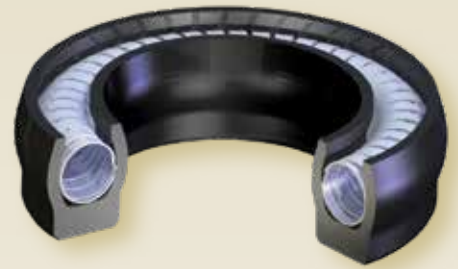

- Unidirectional design for slow speed and static applications
- Helical wound spring design; high load, minimal deflection
- Concentrated load design when friction and wear are secondary concerns
- All seals are made-to-order; no equipment modifications required
- Custom designs and materials available upon request

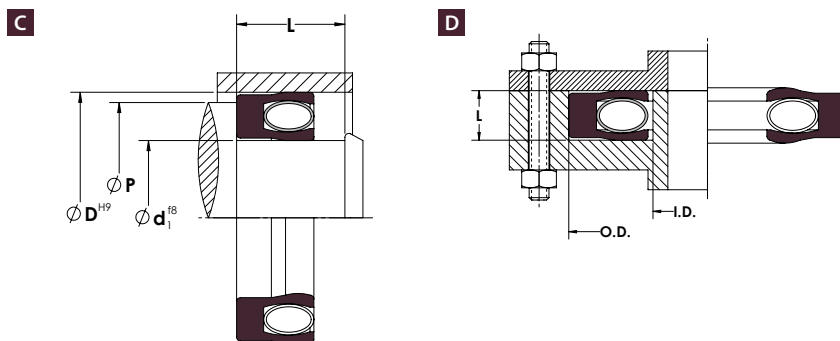
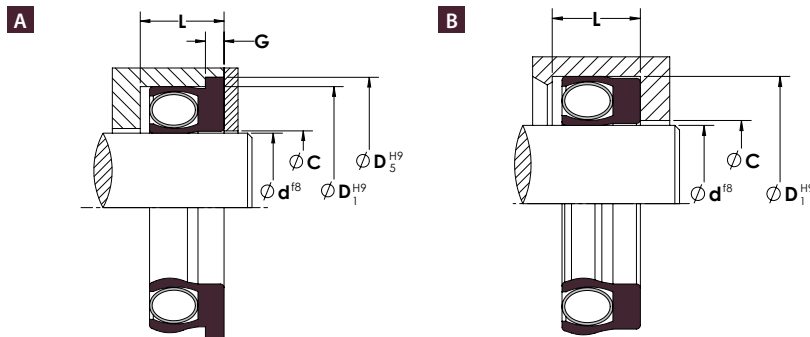



SPECIFICATIONS

Material (designation)	Size Range* mm (inch)	Temperature °C (°F)
AWC400 (PTFE) Carbon and Graphite	1.2 – 2032 (0.050 – 80)	-156 – 204 (-250 – 400)
AWC630 PEEK	1.2 – 254 (0.050 – 10)	-73 – 204 (-100 – 400)
AWC610 UHMWPE	1.2 – 2032+ (0.050 – 80+)	-253 – 82 (-425 – 180)

*Please contact your Chesterton representative for larger sizes.

PRODUCT PROFILES



EPS300



EPS304



EPS305

500 Series

Stacked V-Ring Seals

High Performance, Multi-Purpose V-Ring Sets

High performance, multi-purpose stacked V-Ring sets are ideal for demanding applications, where the reliability and seal performance are requirements, Further, they accommodate hardware with deep stuffing boxes. These stacked sets are used in both rotary and reciprocating applications and are available in solid and split designs, depending upon application requirements.

A typical 500 Series V-Ring set comprises female and male gland adapters (for supporting and energizing functions) and three to five sealing rings, depending on operating conditions and equipment hardware configuration. The gland pressure (energizing axial force) is transferred between the seal rings, pressurizing them and creating optimal, positive contact to the counter surfaces.

Other 500 Series sets incorporate gland adapter ring, several seal rings (V-Rings) and radial Spring Energized Seal Ring. The radial SES ring is the primary sealing element. When it is pressurized by the system pressure, it activates the V-Rings by pushing against the gland adapter ring. The multiple seal edges reduce the risk of a potential leak path. The gland adapter ring provides support to the entire seal set and protects against extrusion.

The 500 Series is available in several unique materials to address a broad range of applications, where chemical compatibility with media, high or low operating temperature, or high speed (fast reciprocating movements) make the application challenging to the seals.

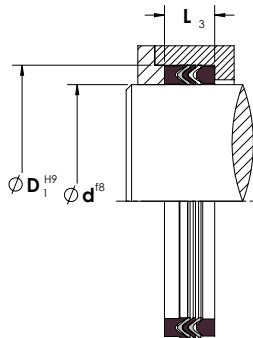

SPECIFICATIONS



Material (designation)	Size Range* mm (inch)	Temperature °C (°F)
AWC400 (PTFE) Carbon and Graphite	1.2 – 2032 (0.050 – 80)	-156 – 204 (-250 – 400)
AWC630 PEEK	1.2 – 254 (0.050 – 10)	-73 – 204 (-100 – 400)
AWC610 UHMWPE	1.2 – 2032+ (0.050 – 80+)	-253 – 82 (-425 – 180)

*Please contact your Chesterton representative for larger sizes.

PRODUCT PROFILES



EPS500 EPS520 EPS521 EPS540

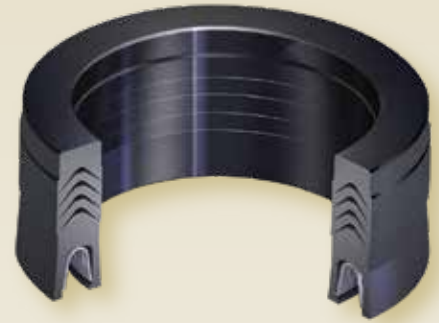

- Unidirectional design, which replace V-Ring sets
- Multi-purpose V-Ring seal sets; plant-wide usage
- All seals are made-to-order; no equipment modifications required
- Custom profiles available
- V-Ring sets accommodate hardware with deep stuffing boxes

600 Series

Continuous Contact Spring Energized Seals

Heavy-Duty, High Load Seals

Continuous contact, robust spring energized seals are primarily used where very high axial loading is required for challenging static and slow rotary, oscillating applications. This design is best utilized in difficult static sealing applications such as gas, cryogenic temperatures, and vacuum. This spring design can also be used in dynamic applications where high torque and clamping forces are present. The geometry of this spring lends itself to larger cross section and diameters.

Continuous spring is a U-shaped spring manufactured with independent grooves originating in the center of the ring and progressing to the outside diameter. Its unique spring design produces the continuous heavy load at the sealing points. The continuous geometry of the spring when wound in a circumference minimizes expansion and contraction due to thermal effects.

The SES Series 600 is available in multiple unique jacket materials to address a broad range of applications. Each seal jacket is used in combination with a high performance, metallic, continuous spring to produce the required high contact load for the positive sealing force against the mating surface.

Utilized seal materials are made from high performance fluoroplastic compounds and engineered plastics that provide low coefficient of friction, high abrasion resistance, dimensional stability, and outstanding resistance to most fluids, chemicals, and gases.

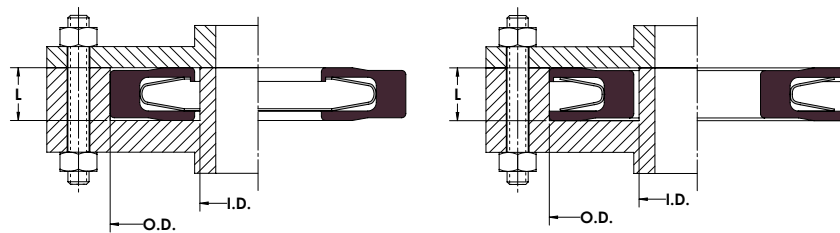

SPECIFICATIONS

Material (designation)	Size Range* mm (inch)	Temperature °C (°F)
AWC400 (PTFE) Carbon and Graphite	1.2 – 2032 (0.050 – 80)	-156 – 204 (-250 – 400)
AWC630 PEEK	1.2 – 254 (0.050 – 10)	-73 – 204 (-100 – 400)
AWC610 UHMWPE	1.2 – 2032+ (0.050 – 80+)	-253 – 82 (-425 – 180)

*Please contact your Chesterton representative for larger sizes.

PRODUCT PROFILES

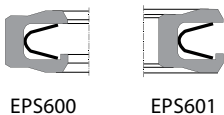

- Continuous contact; robust spring design for tight sealing
- Sealing solution for challenging static and rotary applications
- Ideal solution for large cross sections
- All seals are made-to-order; no equipment modifications required
- Custom profiles available

Engineering Technical Guide

Engineering Introduction and Fundamentals of Fluid Power Sealing Technology

There is a wide variety of fluid power equipment, applications, and operating conditions today, which can make the selection of the most suitable products and solutions difficult and the selection process complex. In addition, the selection of the products and systems are not solely technical questions anymore, but there are economic aspects as well (life cycle costs, maintenance and repair costs, etc.). This engineering introduction section will assist you in understand the fundamentals of fluid power sealing technology and provide a guide for design/profile selection of:

- Hydraulic seals and their classification and basic design aspects
- Classification of hydraulic applications

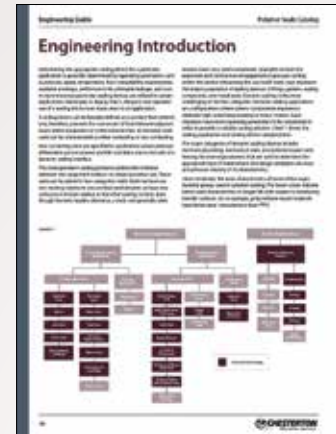

Product Profiles and Descriptions

Choosing the appropriate design for your application will help to maximize seal performance. The product profile reference chart provides the user with a basic guideline for each profile designation and its recommended usage. These profiles coincide with the profiles available through our SpeedSeal™ Program.

- Hydraulic and pneumatic seals
- Rotary seals and spring energized seals



Design Guidelines for Hardware Design

Designing your hardware to international standards will help to ensure that maximum seal performance is realized; help to improve efficiency of fluid power products and systems; assure system integrity and interchangeability; and make it easier for designers, manufacturers, and users to communicate. Chesterton products are used in a wide array of applications including hydraulic, pneumatic, rotary, reciprocating, oscillating, and static. Our designs have been developed, through years of experience, to maximize seal performance based on the guidelines provided.

- Hardware guidelines
- ISO fits and tolerances



Materials Matrix

Choosing the proper material to coincide with the seal design of choice provides the best opportunity to maximize seal performance. Chesterton has an extensive materials portfolio that includes in excess of 100 products—many of which are custom blended to accommodate specific end user requirements. This section highlights our most popular materials and is supported by pertinent specifications for polymer seals.

- General usage
- Properties

This table provides a comprehensive overview of Chesterton's polymer seal materials. It lists various materials such as NBR, EPDM, FKM, and PTFE, along with their specific applications, chemical compatibility, and physical properties. The table is organized into columns for material type, general usage, and detailed properties.

Chemical Compatibility

Chesterton products are used in a wide range of hydraulic, pneumatic, and rotary equipment. Since fluid can vary drastically by application, the proper choice of a seal material can have a major impact on seal performance. The chemical compatibility reference chart provides guidelines according to relevant ISO fluid classification standards identifying and appropriate material for your application.

- Fluid listing
- Materials guideline

The Chemical Compatibility chart is a grid-based reference tool. It lists various fluids (e.g., Water, Glycerin, Mineral Oil, Hydraulic Oil, etc.) in the rows and different seal materials in the columns. The cells in the grid indicate the compatibility level between the fluid and the material, helping users select the most suitable seal for their specific application.

Troubleshooting Guide

This guide is provided for use as a reference when repacking, rebuilding, or redesigning any cylinder or press. Based on real life experience, this section offers pictures and examples for recommended sealing solutions. The key to improving performance in future applications is to understand how and why seals fail prematurely.

- Probable causes
- Possible solutions

The Troubleshooting Guide section includes several diagrams and text-based instructions. It addresses common seal failure modes such as extrusion, leakage, and wear. Each issue is accompanied by a diagram showing the failure point and a corresponding text box that explains the probable cause and offers practical solutions for prevention or repair.

Engineering Action Request and Industrial Cylinder Survey Forms

The Chesterton Engineering Action Request and Industrial Cylinder Survey forms are utilized to capture all the pertinent details regarding a specific application. With this information in hand, our technical support team, field specialists, and engineers are able to better understand your application and assess the various options available to you.

- Application details
- Hardware dimensions

The Engineering Action Request Form is a structured document for gathering technical information. It includes sections for identifying the user and the application, providing detailed descriptions of the equipment and seal issues, and specifying hardware dimensions. The form is designed to ensure all necessary data is collected for a thorough engineering analysis.

Engineering Introduction

Determining the appropriate sealing device for a particular application is generally determined by operating parameters such as pressure, speed, temperature, fluid compatibility requirements, available envelope, performance life, allowable leakage, and cost. In many instances particular sealing devices are utilized in certain applications due largely to legacy, that is, the prior and repeated use of a sealing device over many years in an application.

A sealing device can be broadly defined as a product that controls and, therefore, protects against the movement of fluid between adjacent locals within equipment or to the environment. At the basic level seals can be characterized as either contacting or non-contacting.

Non-contacting seals are specified in applications where pressure differentials are not present and life is limitless due to the lack of a dynamic sealing interface.

The more prevalent sealing products address the interface between two equipment surfaces to create a positive seal. These seals can be placed in two categories: static (both surfaces are non-moving relative to one another) and dynamic (at least one surface is in motion relative to the other sealing surface). Even though the term implies otherwise, a static seal generally does

involve some very small movements. Examples include the expansion and contraction of equipment or pressure cycling within the system influencing the seal itself. Static seals represent the largest population of sealing devices: O-Rings, gaskets, sealing compounds, and metal seals. Dynamic sealing is the more challenging of the two categories. Dynamic sealing applications are configurations where system components experience relatively high-speed reciprocating or rotary motion. Such situations have more operating parameters to be considered in order to provide a suitable sealing solution. *Chart 1* shows the sealing application and sealing device categorization.

The major categories of dynamic sealing devices include mechanical packing, mechanical seals, and polymer-based seals. Among the several parameters that are used to determine the appropriate type of material and seal design utilization are wear and pressure-velocity (P-V) characteristics.

Chart 2 indicates the wear characteristics of some of the major material groups used in polymer sealing. The lower values indicate better wear characteristics or longer life with respect to interfacing metallic surfaces. As an example, polyurethane-based materials have better wear characteristics than PTFE.

CHART 1

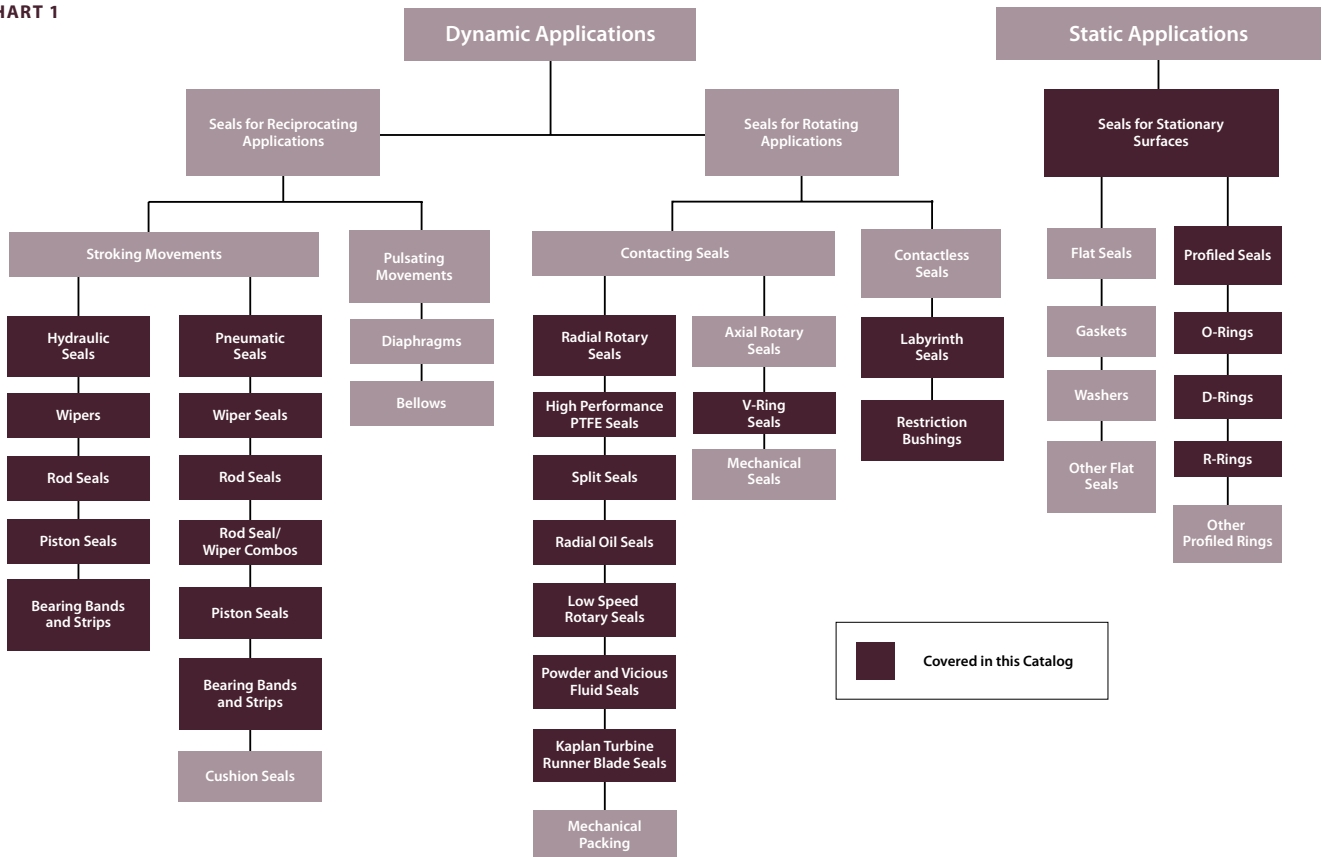

Although this chart provides some insight into the relative wear characteristics, the materials have limits to the level of pressure and velocity each can withstand for suitable service.

A factor expressed as the product of pressure and velocity provides a reference value for the level at which materials and seal designs can practically endure. Such values relate to equipment operating parameters. It is convenient to integrate both material and seal design configuration to look at which provides appropriate performance. *Chart 3* provides some general ranges by seal type relating to pressure and velocity.

In the case of polyurethane, the material is generally used without external loading (e.g., springs) due to its unique characteristics, which allows it to return to its original shape. As indicated on *Chart 3*, polyurethane materials are generally recommended for use at lower speeds and higher pressures.

Rotary seals are generally not loaded with springs and typically utilize various PTFE compounds. Rotary seals can be used at higher surface velocities with lower pressures.

Spring energized seals, used in both rotary and reciprocating applications, cover a very broad range of pressure and velocity characteristics.

These include various spring types (e.g., cantilever, helical, and elliptical) and materials used to satisfy the equipment operating parameters. Spring energized seals can be used at relatively high pressures or surface velocities.

CHART 2

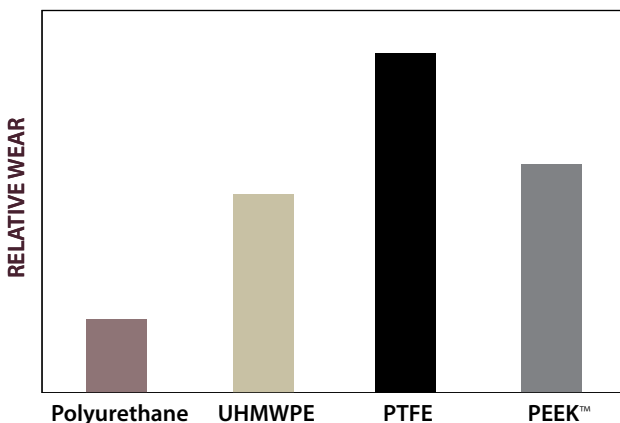
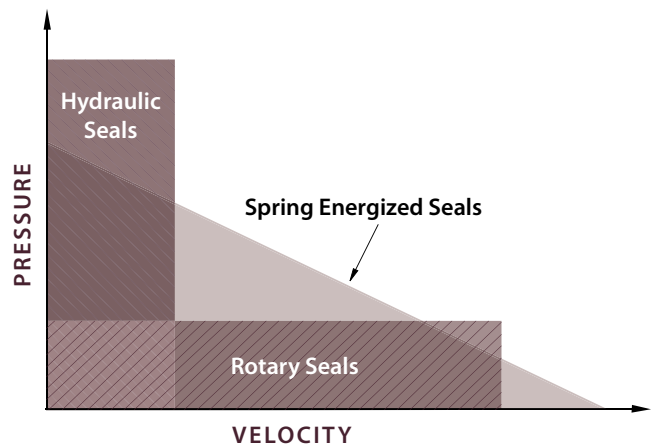

CHART 3



Hydraulic Seals

Chesterton high performance hydraulic sealing components provide solutions for a wide range of modern hydraulic equipment including light-, medium-, and heavy-duty applications. Chesterton offers a broad range of standard- and custom-designed solutions for special applications.

The major functions of the hydraulic seals are to:

- Retain fluid in the system
- Hold fluid or system pressure in order to maintain the system efficiency
- Exclude contamination (solid and liquid) from the working environment in order to protect the system
- Eliminate metal-to-metal contact between the relative moving components of the cylinders
- Provide transversal support and longitudinal guide to the moving components of the cylinders

There are additional considerations for sealing components in the hydraulic systems such as:

- High system pressure
- Shock load on cylinders that results in pressure spikes
- High temperature fluctuation
- Extreme temperature conditions (low and high)
- High transverse (side) load and force on cylinders which causes deflection
- Harsh environment (dirty conditions)
- High stroking speed
- Increased cycle number

These lead to increased equipment stress as well as increased load on seal components.

The wide range of Chesterton’s hydraulic sealing product portfolio covers:

- Wiper seals
- Rod Seals
- Piston Seals
- Wear Rings and Strips
- Static Seals

These match all individual application requirements from all industries. Categorization of hydraulic seals by function is demonstrated in the chart below.

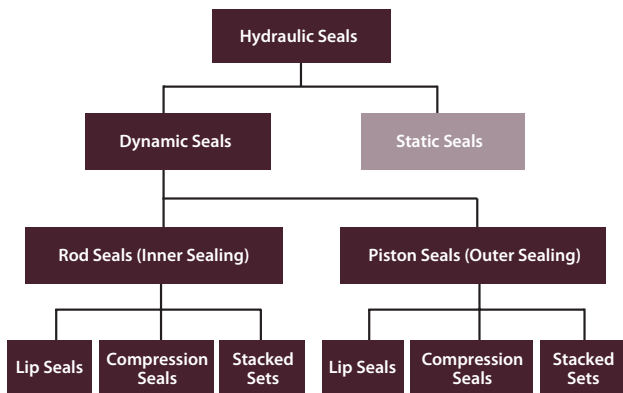

Seal Design

All hydraulic seals require a basic radial pressure in common, in order to provide tight sealing in either pressureless or low-pressure operating conditions. There are three groups of seals which are designed based on how the radial pressure (sealing force) is generated:

- Lip seals: radial pressure is generated by a deformation of the flexible lips of the seal
- Compression seals: radial pressure is generated by a deformation of the entire cross section of the seal
- Stacked sets: radial pressure is generated by a precompression of the seal set in axial direction

The chart below demonstrates the three basic seal designs and their free state and installed/fitted conditions.

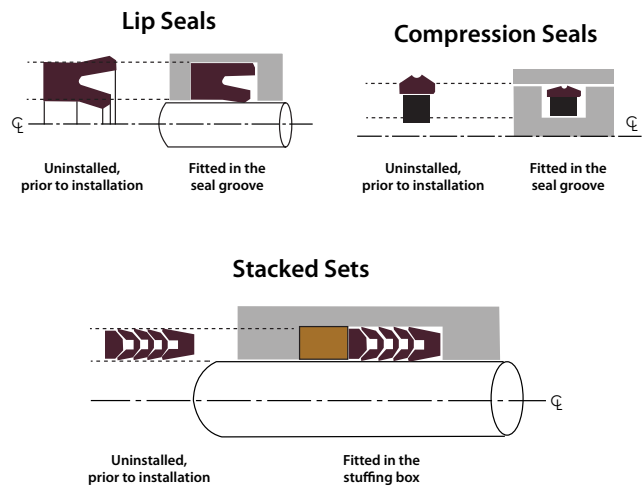

The amount of the radial pressure that the seal lip exerts against the sealing surface will give the lip loading. Such loading is determined by the seal design. Pure lip-type seals have very low lip loading, as the lips are deformed during installation and take substantially less effort to deform. While in contrast, pure, squeeze-type (compression) seals have high lip loading, even at either zero or low fluid pressure, as the initial deformation during installation requires more effort.

Lip loading determines friction: wear that is generated on the seals and its sealability at zero pressure. That is why friction and wear will be lower on pure lip seals, while pure compression seals have higher friction and wear values. Sealability of pure compression seals is better at zero and/or low system pressure. The following chart summarizes important properties of seals from pure lip to pure compression seals and compares friction, wear, breakaway force, sealability, hydroplaning resistance, and performance of the seals in contaminated fluids.

As fluid pressure increases, the difference between the seal designs becomes less significant because the fluid pressure force overcomes the initial, designed radial force. In addition, the fluid pressure generally increases sealability controls leaks but also increases friction, wear, and heat generation (called contact heat) in the contact area.

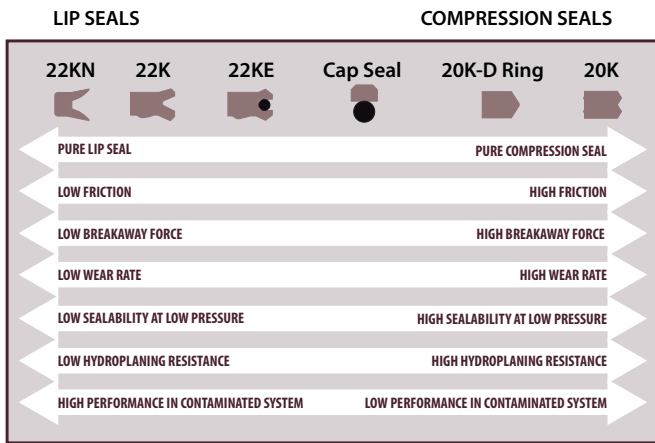

overload and compression set. That is why reducing friction is a general goal in most seal applications. There are several factors which affect the generated friction. The chart below summarizes the factors by radial force and coefficient of friction.

FACTORS	
Seal radial force	Coefficient of friction
<ul style="list-style-type: none"> Seal design (lip vs. compression seal) Lip geometry Fluid pressure Temperature Material modulus 	<ul style="list-style-type: none"> Seal material Temperature Stroking speed Dynamic surface roughness Dynamic surface profile Hydraulic fluid

Lip Configuration

Lip configuration (geometry) will affect several functions of the seal:

- Low-pressure sealing (by force concentration on the mating surface)
- Sealability (fluid film breaking ability)
- Hydroplaning resistance (when seal rides up onto the fluid film and cannot break the film, resulting in leakage)
- Contamination exclusion

The chart below shows the basic lip geometries in free state and installed conditions, comparing their properties from sealability, hydroplaning resistance, and contamination exclusion points of view, to help you choose the appropriate lip geometry.

LIP CONFIGURATION							
Sample seal	Seal lip shape	Seal lip installed	Shape of contact force/pressure distribution	Sealability	Film breaking ability	Hydroplaning resistance	Contamination exclusion
				Medium	Low	Low	High
				High	High	High	Low
				High	High	High	Medium
				Medium	Medium	Medium	Low
				Medium	Low	Low	Medium

We can distinguish static and dynamic friction coefficients of the seal materials. Static (stationary) friction values will be higher compared to dynamic. This is caused by the fact that as seal materials conform to the mating surfaces profile they force lubrication out from between the seal and counter surface (boundary friction). A longer duration of the stationary condition will increase the static friction and increase the breakaway force (caused by breakaway friction, which must be overcome to begin the movement).

At elevated velocities the friction will be decreased because more lubrication is provided by the hydraulic fluid between the seal and counter surface (which is called mixed friction). Mixed friction will be decreased to its realizing point, then the friction will start to increase again as a result of increased internal friction of the hydraulic fluid. Friction conditions based on velocity are shown in the chart below.

Friction Conditions Prevailing Inside the Cylinder

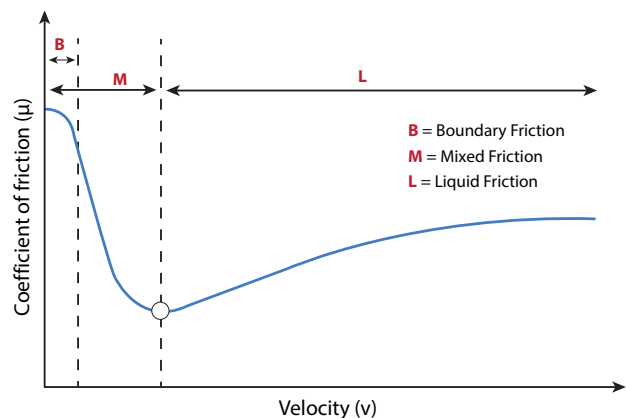

Friction

Friction generated is the result of radial force and the coefficient of friction between the seal mating surfaces. Friction causes heat generation (contact heat), which reduces system efficiency (energy consumption), and seal wear, which reduces service life. Reducing friction improves seal service life by reducing wear, and it helps to improve extrusion resistance and heat related matters, just like thermal

If friction is a critical factor in the cylinder, there are several options to reduce it:

- Reduce the lip radial force (seal design and lip geometry)
- Check surface roughness and profile
- Improve lubrication (change hydraulic fluid)
- Reduce system pressure or pressure that is exposed to the seal
- Locally change seal material

One of the most feasible ways to reduce friction prevailing inside the cylinder is to use seal material that has a lower coefficient of friction. The chart below shows coefficients of friction (static coefficient of friction against polished stainless steel mating surface) of some typical seal materials. If the seal material changes, several other factors, such as chemical compatibility, temperature etc., must be taken into consideration in order to make the appropriate material selection.

Typical elastomers (rubber-like materials) have relatively high coefficients of friction, while PTFE compounds show the lowest.

Coefficient of Friction of Different Seal Materials

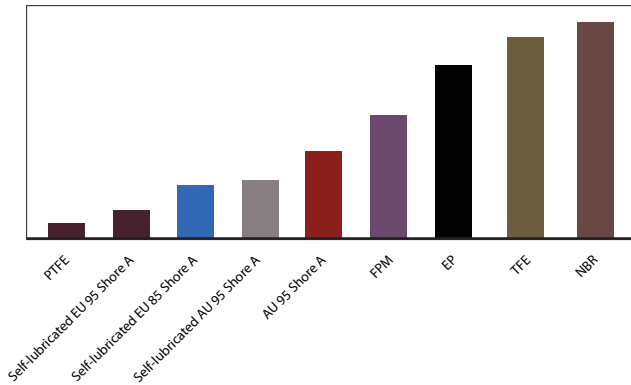

One possible consequence of the high friction on seals is the stick-slip (distinct start-stop) movement of the cylinder. Sometimes is so fast, that it may be observed as a vibration. Further stick-slip can cause either noise or chatter. It must be mentioned that stick-slip can be caused by other factors, such as heavy side load, high operating temperature, poor fluid lubrication, etc.

Other Factors

There are several other factors that will determine the seal performance, service life time, and service intervals:

Surface speed (velocity): excessive speed may increase the frictional heat (contact heat) or hydroplaning, while slow speed can result in stick-slip.

Seal stability: stability of the seals in dynamic operation is crucial, as it is going to allow the seal lip top to properly contact the mating surface. Instability can lead to leakage and seal damage.

Seal extrusion: please see *Allowable Diametrical Clearance Section (p.118)* for further details.

Temperature: all seal material has its specific operating temperature range (please see *Operating Temperature Range chart p. 125*). Seal materials maintain their physical properties within the allowable temperature range limit, while the properties are significantly degraded as their limits are exceeded.

Temperature may will have an affect on friction, wear, extrusion, and compression set.

Compression set: compression set is a permanent deformation of a seal—the meaning inability of the seal component to return to its original shape and size. Compression set reduces radial lip (sealing) force, causing salability issues at low system pressure. Compression set is the percent of deflection by which the seal fails to recover after a defined deflection, temperature, and time. Please see the chart below.

$$\text{Compression Set} = \frac{(H_i - H_r)}{(H_i - H_c)} \times 100\%$$

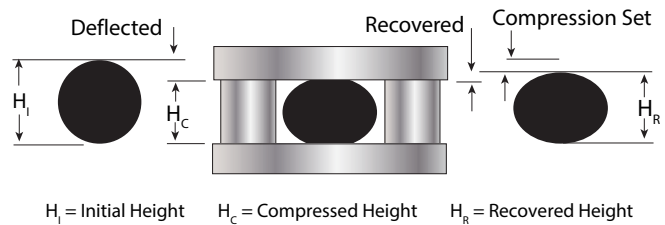

Criteria for Optimal Seal Selection

Extended, leak- and trouble-free service can be achieved by installing high performance, longer lasting seal component parts in the properly designed cylinder.

Focus on:

- The right seal profile for the specific application and operating conditions
- The optimal seal material for the type of stresses or abrasion impacting the equipment and the condition of the equipment itself
- The positive rake wipers for more effectively cleaning and dislodging foreign matter from retracting rods to prevent scoring and system contamination
- High-load capability guiding elements for moving components, handling radial forces, and avoiding metal-to-metal contact inside of the cylinders

The following application factors should be considered:

- **Fluid pressure range:** maximum operating pressure and/or pressure peaks (frequency and severity) caused by dynamic shock loads on cylinders
- **Temperature range:** The range of the fluid and seal application temperature both in operation and in standstill position
- **Operating speed:** The stroking speed of the reciprocating motion (and possible vibration)
- **Hydraulic media:** Type and viscosity of fluid used in the system
- **Hardware dimensions:** Rod and bore diameters, seal groove dimensions, and clearances
- Application and operation of the cylinder
- Physical condition of the equipment

Seal Selection

The above criteria will affect the selection of the optimum seal materials, profiles, and, in combination, the complete seal system. The most important features of proper seal and bearing components for superior performance are:

- High wear and abrasion resistance
- High pressure resistance
- High temperature resistance
- Long-term elastic memory
- Outstanding extrusion resistance
- High-load capability

Properly selected seal material and seal design and suitable seal system arrangement will influence the equipment performance. The graphic below summarizes the primary factors that affect the overall seal and equipment performance.

Cylinder and Application Classification

Seal performance and reliability are essential to the performance of the cylinder press. That is why appropriate seal selection is important and will be influenced by the cylinder type and by application (operating and environmental conditions). There is no industrial standard established or available for application and/or operating conditions. However, it is still important to set certain criteria and parameter limits that help to describe and classify the hydraulic applications. The suggested classification is according to the chart on the right.

Application criteria	HYDRAULIC CYLINDER APPLICATION CLASSES		
	Light-Duty	Medium-Duty	Heavy-Duty
System pressure MPa (psi)	14 (2000)	25 (3625)	40+ (5800+)
Pressure peaks	None or rare and low	Moderated, what does not exceed the system pressure significantly in combination with short duration	High pressure peaks, what can exceed the system pressure several times. Can occur often in combination with longer duration
Temperature range °C (°F)	Up to 60 (140)	Up to 80 (176)	Exceeding 80 (176) with peaks in excess of 120 (248)
Surface speed m/s (ft/min)	0.1 (20)	0.5 (100)	1.0 (200)
Side loading	None to minimal side load on guide components (short stroke cylinders and cylinders are in vertical position)	Moderate side load on guide components (medium stroke cylinders and cylinders close to vertical position)	Heavy side load on guide components (large cylinders, heavy components). Long stroke cylinders and cylinders are in horizontal position
Environment	Low temperature fluctuation	Moderate temperature fluctuation	High temperature fluctuation
Contamination	Free or low	Moderate (or cylinder in horizontal, down-stroke position)	Harsh environment with high contamination (cylinders are in vertical, up-stroke position)

Considerations for Reliable Cylinder Sealing

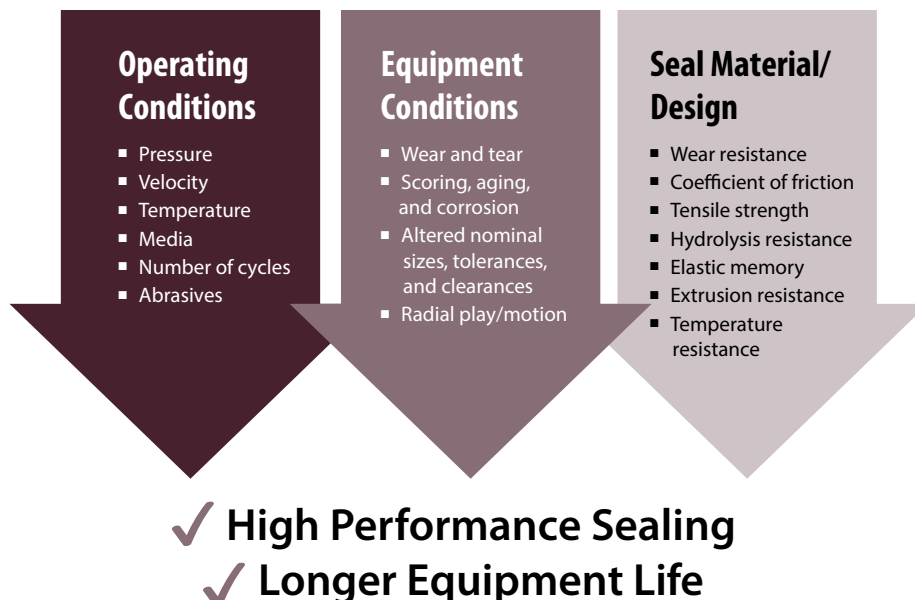

Profile Guide

Wipers

The function of a wiper is to effectively clean and dislodge foreign matter from a reciprocating rod/ram to prevent contaminants from entering the system.

21K STANDARD WIPER

Positive rake wiper designed to effectively clean and dislodge foreign matter from retracting rod/ram to protect against scoring and system contamination.

Profile	Description
W21KF	Machined wiper with flange design
W21KT5	Machined wiper to accommodate taller groove heights while providing added stability
W21K	Machined wiper with static bump flange design to eliminate migration of contaminants
W21KC	Machined combination wiper and rod seal, pneumatic use only
W21KC1	Machined combination wiper and rod seal with static stabilizing bump, pneumatic use only
W21KCS	Machined combination wiper and rod seal designed with stepped flange, pneumatic use only
W21KM	Machined wiper designed with snap-in fit for specific equipment types
W21KR	Machined wiper with static flange bump and stabilizing heel
W21KS	Machined wiper profile with stepped flange
WCCS	Machined wiper using an O-Ring loader for use with polyurethane or PTFE compounds

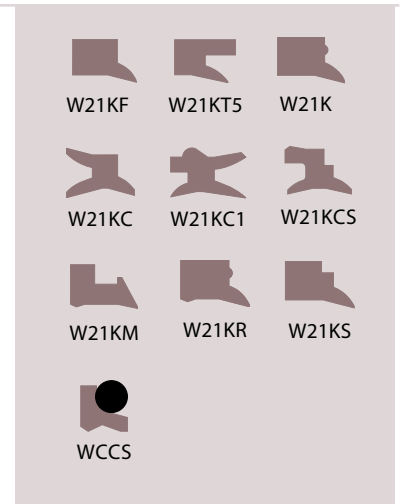

21K CANNED WIPERS

Positive rake canned wiper designed to effectively clean and dislodge foreign matter from retracting rod/ram to protect against scoring and system contamination. A canned wiper is a press-fit design for use in an open housing groove and does require an additional retaining device due to the interference fit.

Profile	Description
CW21K	Machined dual-component, full canned stepped flange canned wiper design
CW21K1	Machined dual-component, partial stepped flange canned wiper design
CW21K2	Machined dual-component with taller static lip canned wiper design
CW21K3	Machined dual-component, full canned wiper design

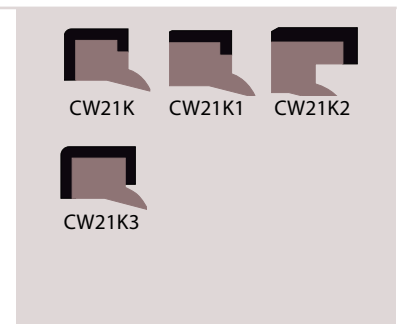

Rod Seals — U-Cups

The function of a rod seal is to protect against fluid bypass along the dynamic (rod /ram) and static (stuffing box bore) surface under various operating conditions. A U-Cup design refers to a continuous seal ring with a profile similar to the letter u.

22KN U-CUPS

A continuous, single-acting rod or piston seal U-Cup design that wipes contaminants away from the mating surface while in operation. The positive rake, lip profile provides an optimal amount of radial sealing load with minimal frictional resistance. It is designed for use in hydraulic or pneumatic applications.

Profile	Description
R22KN	Machined rod seal design for use in hydraulic or pneumatic cylinders and presses
R22KN1	Machined rod seal design with a standoff ring for vacuuming situations
R22KN5	Machined rod seal design with taller static lip for added stability and to resist vacuuming
R22KNH	Machined rod seal with flange design, for replacement as a hat seal

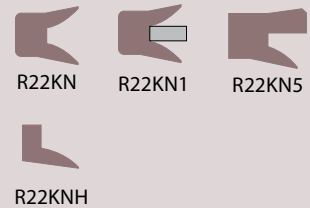

6K U-CUPS

Continuous, single-acting U-Cup design with a positive rake profile that wipes contaminants away from the mating surface while in operation. The rugged, rubber-based construction is ideal for older, worn hydraulic cylinders and presses since it conforms to surface irregularities to effectively control leakage.

Profile	Description
R6K	Molded rod seal design for use in older, worn equipment



22K U-CUPS

A continuous, single-acting rod or piston hydraulic seal design with a special lip geometry that increases lip preload and provides zero leakage throughout the entire operating range. The sturdy, static lip stabilizes the seal to prevent rolling while the negative rake lip profile eases installation.

Profile	Description
R22K	Machined rod seal for hydraulic cylinders and presses
R22KAER	Machined rod seal that includes a partial, rectangular anti-extrusion ring for equipment exposed to excessive clearances and pressure spikes
R22KAER1	Machined rod seal that includes a custom anti-extrusion ring for equipment exposed to excessive clearances and pressure spikes



22KE U-CUPS

A continuous, single-acting, rod or piston design incorporates the use of an O-Ring to increase preload capabilities to improve low-pressure sealing capabilities and high shock load load capabilities in hydraulic applications. The O-Ring energizes the seal which increases the preload capabilities of the seal in the absence of system pressure.

Profile	Description
R22KE	Machined rod seal with O-Ring energizer for hydraulic cylinders and presses
R22KEAER	Machined rod seal with O-Ring energizer that includes a partial, rectangular anti-extrusion ring for equipment exposed to excessive clearance and pressure spikes
R22KEAER1	Machined rod seal with O-Ring energizer that includes a partial, anti-extrusion ring for equipment exposed to excessive clearances and pressure spikes



23K U-CUPS

A continuous, single-acting rod or piston design that incorporates a unique, dynamic lip geometry that provides the optimal sealing force required for pneumatic applications.

Profile	Description
R23K	Machined continuous rod seal design



Rod Seals — Stacked Sets

Stacked V-Ring seal designs are most commonly used to ensure ease of installation due to the split design, although, in some cases, continuous designs are preferred. These V-Ring sets incorporate sealer rings that are nested inside a female/top and a male/bottom adapter. The number of sealer rings used in a set is predicated upon system pressure. The male adapter is used to ensure alignment of the sealer rings while also helping to energize the set under system pressure. The female adapter is designed to ensure alignment and support of the set while helping to compensate for extrusion into large equipment clearances.

8K/27K/28K STACKED SETS

The pressure-activated rod and piston V-Ring sets are used in hydraulic applications. The single-acting, positive rake profile contacts through the center of the set to provide even loading and longer sealing life using minimal gland pressure. Most sets are available split or solid.

Profile	Description
R8K	Molded, single-acting, symmetrical seal set, available split or solid
R27K	Machined, single-acting, symmetrical seal set, available split or solid
R27K1	Machined, single-acting, symmetrical seal set with custom adapters for large clearances
R28K	Machined, single-acting, symmetrical seal set for replacement of typical industry sets
R28K1	Machined, single-acting, symmetrical seal set with adapters made from engineered plastics for added support and extrusion resistance
R28K2	Custom machined, single-acting, symmetrical seal set with male adapters made from engineered plastics for added support and extrusion resistance

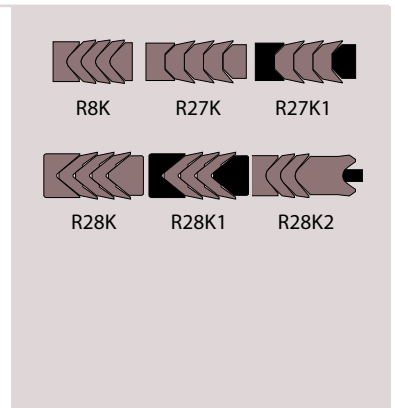

11K STACKED SETS

The single-acting, two-piece, stacked rod seal set employs a negative rake design to optimize operating performance while easing installation into the stuffing box cavity. The bottom ring is the primary sealer while the top ring works as an anti-extrusion ring, provides secondary sealing, and provides added support to the sealer ring. The set is available in various material combinations as well as split or solid designs.

Profile	Description
R11K	Molded or machined, symmetrical seal for hydraulic applications
R11KSPCR	Molded or machined, custom spacer used with seal set to help compensate for vacuuming, side loading conditions, or shock loading conditions
R11KWSPCR	Molded or machined, single-acting, two-piece stacked set with a custom-designed spacer to help compensate for vacuuming conditions

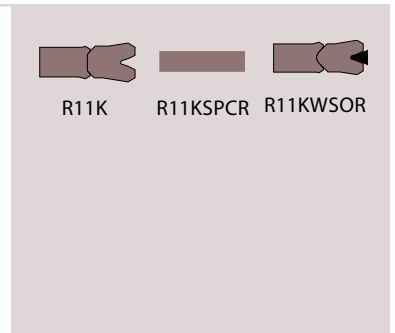

600 STACKED SETS

Single-acting, conventional compression stacked V-Ring set that enables increased seal loading against sealing surfaces with increased gland pressure while the rubber-based material conforms to surface imperfections to control leakage. The set includes sealer rings and a bottom adapter.

Profile	Description
R600	Molded, single-acting, conventional stacked design for older, worn equipment, available split or solid

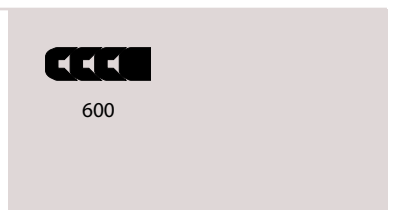

Rod Seals — Compression, Static

Compression type seals are typically designed with a higher initial preload which helps to control leakage at low pressure. These profiles are typically used in a single-cavity groove but are able to seal pressure in both directions.

RCCS ROD—COMPRESSION SEALS

Continuous, two-piece, bidirectional sealing system that uses an elastomer cap with an O-Ring to create a very effective seal for single-groove cavities in hydraulic applications. The cap is used as the dynamic sealing element while the O-Ring energizes the cap and creates a static seal.

Profile	Description
RCCS	Machined, two-piece rod seal with an elliptical cap profile for more efficient loading in hydraulic applications
RCCS1	Machined, two-piece rod seal with a standard profile for use in hydraulic applications
RCCS2	Machined, two-piece rod seal with a rectangular loader for use in highly dynamic hydraulic applications
RCCS3	Machined, two-piece rod seal with a stepped cap profile for use in hydraulic applications
RCCS4	Machined, two-piece piston seal with a rectangular loader and a stepped cap profile for use in highly dynamic hydraulic applications

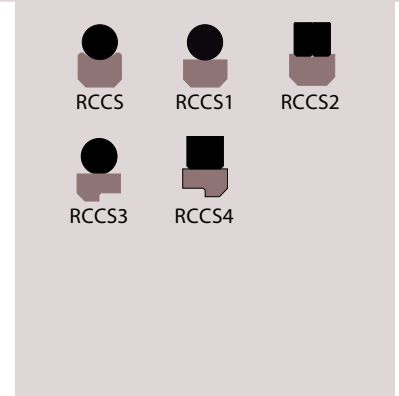

20K COMPRESSION

Continuous, bidirectional compression seal with dual independent sealing points. The heavy, durable, dual lip design is used for single-groove cavities in heavy-duty, high-pressure hydraulic applications. The seal has the ability to withstand pressure spikes while helping to compensate for equipment side loading and maintain high unit loading.

Profile	Description
R20K1	Machined, heavy-duty rod seal for use in hydraulic applications
R20K2	Machined, heavy-duty rod seal with full anti-extrusion ring
R20K3	Machined, heavy-duty rod seal with partial anti-extrusion ring
R20KDAER	Machined, heavy-duty rod seal with two partial anti-extrusion rings

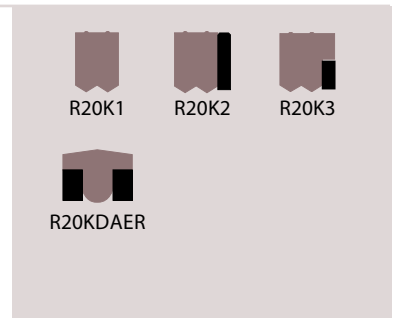

20KD STATIC/FACE

A continuous, high performance compression seal that is most commonly used in static applications and is often applied as an upgrade from conventional O-Rings. Designs are available for internal face sealing as well as external face sealing commonly found in single- or double-acting applications.

Profile	Description
R20KDR	Machined seal and the D profile and the dynamic seal profile located on the inner diameter
20KDRFS	Machined profile for face sealing with the dynamic seal profile located on either the top or bottom
OR1	Machined seal for replacement of an O-Ring
20KOR	Machined rectangular seal for sealing static connecting ports of standard hydraulic valves and control units
OR	Machined seal for replacement of a Molded conventional O-Ring

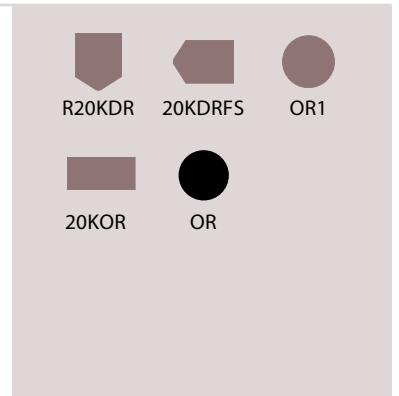

Piston Seals — U-Cups

The function of a piston seal is to protect against fluid bypass between the piston head and cylinder bore under various operating conditions.

22KN U-CUPS

A continuous, single-acting, rod or piston seal, U-Cup design that wipes contaminants away for the mating surface while in operation. The positive rake, lip profile provides an optimal amount of radial sealing load with minimal frictional load. It is used in hydraulic or pneumatic applications.

Profile	Description
P22KN	Machined, piston seal design for use in hydraulic or pneumatic cylinders and presses
P22KN1	Machined, piston seal design with a standoff ring for vacuuming situations
P22KN5	Machined, piston seal design with taller static lip for added stability and to resist vacuuming



22K U-CUPS

A continuous, single-acting, rod or piston hydraulic seal design with a special lip geometry that provides zero leakage throughout the entire operating range. The sturdy, static lip stabilizes the seal to protect against rolling while the negative rake lip profile eases installation.

Profile	Description
P22K	Machined piston seal for hydraulic cylinders and presses
P22KAER	Machined piston seal that includes a partial, rectangular anti-extrusion ring for equipment exposed to excessive clearances and pressure spikes
P22KAER1	Machined piston seal that includes a custom anti-extrusion ring for equipment exposed to excessive clearances and pressure spikes

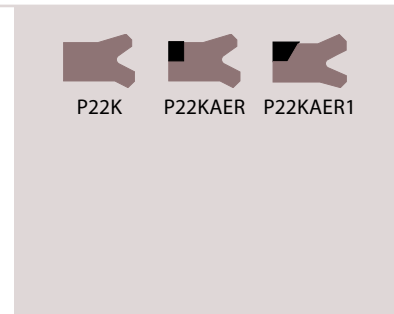

22KE U-CUPS

A continuous, single-acting, rod or piston design incorporates the use of an O-Ring to increase preload capabilities for extreme low-pressure sealing capabilities in hydraulic applications. The O-Ring energizes the seal which increases the preload capabilities of the seal in the absence of system pressure.

Profile	Description
P22KE	Machined piston seal with O-Ring energizer for hydraulic cylinders and presses
P22KEAER	Machined piston seal with O-Ring energizer that includes a partial, rectangular anti-extrusion ring for equipment exposed to excessive clearance and pressure spikes
P22KEAER1	Machined piston seal with O-Ring energizer that includes a custom anti-extrusion ring for equipment exposed to excessive clearances and pressure spikes

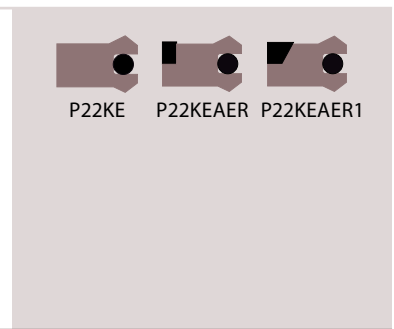

23K U-CUPS

A continuous, single-acting, rod or piston design that incorporates a unique, dynamic lip geometry that provides the optimal sealing force required for pneumatic applications.

Profile	Description
P23K	Machined, continuous piston seal design



Piston Seals — Stacked Sets

Stacked V-Ring seal designs are most commonly used to ensure ease of installation due to the split design. The sealer rings are nested inside a female/top and a male/bottom adapter. The male adapter centers the sealer rings while also energizing the set under system pressure. The female adapter supports the set and helps compensate for extrusion into large equipment clearances.

8K/27K/28K STACKED SETS

The pressure-activated rod and piston V-Ring sets are used in hydraulic applications. The single-acting, positive rake profile contacts through the center of the set to provide even loading, and longer sealing life using minimal gland pressure. Most sets are available split or solid.

Profile	Description
P8K	Molded, single-acting, symmetrical seal set, available split or solid
P27K	Machined, single-acting, symmetrical seal set, available split or solid
P27K1	Machined, single-acting, symmetrical seal set with custom adapters for large clearances
P28K	Machined, single-acting, symmetrical seal set for replacement of typical industry sets
P28K1	Machined, single acting, symmetrical seal set with adapters made from engineered plastics for added support and extrusion resistance
P28K2	Custom machined, single-acting, symmetrical seal set with male adapters made from engineered plastics for added support and extrusion resistance

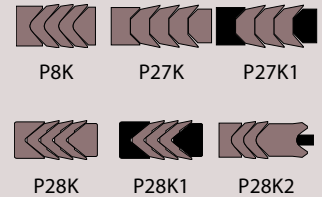

11K STACKED SETS

The single-acting, two-piece stacked piston seal set employs a negative rake design to optimize operating performance while easing installation into the piston head seal cavity. The bottom ring is the primary sealer, while the top ring works as an anti-extrusion ring, provides secondary sealing, and provides added support to the sealer ring. The set is available in various material combinations. Only solid design is available.

Profile	Description
P11K	Machined, symmetrical seal for hydraulic applications
P11KWSPCR	Machined, symmetrical seal with standoff ring for hydraulic applications

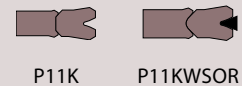

Piston Seals — Compression

CCS COMPRESSION

Continuous, two-piece, bidirectional sealing system that uses an elastomer cap with an O-Ring to create a very effective seal for single-groove cavities in hydraulic applications. The cap is used as the dynamic sealing element while the O-Ring energizes the cap and creates a static seal.

Profile	Description
PCCS	Machined, two-piece, piston seal with an elliptical cap profile for more efficient loading in hydraulic applications
PCCS1	Machined, two-piece, piston seal with a standard profile for use in hydraulic applications
PCCS2	Machined, two-piece, piston seal with a rectangular loader for use in highly dynamic hydraulic applications
PCCS3	Machined, two-piece, piston seal with a stepped cap profile for use in hydraulic applications
PCCS4	Machined, two-piece, piston seal with a rectangular loader and a stepped cap profile for use in highly dynamic hydraulic applications

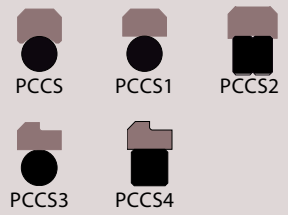

20K COMPRESSION

Continuous, bidirectional compression seal with dual independent sealing points. The heavy, durable, dual lip for single-groove cavities in heavy-duty, high-pressure, hydraulic applications. The seal design has the ability to withstand pressure spikes while helping to compensate for equipment side loading.

Profile	Description
P20K1	Machined, heavy-duty piston seal for use in hydraulic applications
P20K2	Machined, heavy-duty bidirectional piston seal with two full anti-extrusion rings
P20K3	Machined, heavy-duty piston seal with two partial anti-extrusion rings
P20K4	Machined, heavy-duty piston seal with two full L-shaped anti-extrusion rings
P20K5	Machined, heavy-duty, piston seal with two partial L-shaped anti-extrusion rings
P20K6	Machined, heavy-duty, piston seal with two partial L-shaped anti-extrusion rings
P20KDAER	Machined, heavy-duty, piston seal with two sturdy rectangular anti-extrusion rings
P20K2P4	Machined, heavy-duty, 4-piece piston seal with two full L-shaped anti-extrusion rings



7K PISTON CUP

Single-acting piston cup has a positive, flared lip design to optimize sealing forces. The molded design is supplied with a supporting, metallic brass disc molded into the base of the seal to prevent overcompression of the flange and improve seal performance. The resulting rigid base provides a stable, non-distorting, anti-extrusion-resistant seal. These can also be used back-to-back for double-acting applications.

Profile	Description
P7K	Molded piston cup seal design with built-in supporting metallic brass disc in the base to improve stability and anti-extrusion resistance
P7K1	Machined piston cup seal design (does not include a built-in brass disc)



20KD PISTON MOUNTED – STATIC FACE

A continuous, high-performance compression seal that is most commonly used in static applications and is often applied as an upgrade from conventional O-Rings. Designs are available for internal face sealing as well as external face sealing commonly found in single- or double-acting applications.

Profile	Description
P20KDR	Machined seal profile with dynamic side located on the inner diameter
20KOR	Machined rectangular seal for sealing static connecting ports of standard hydraulic valves and control units



Ancillary Devices — Anti-extrusion Rings (AER)

9K ANTI-EXTRUSION RINGS (AER)

Anti-extrusion rings, sometimes referred to as backup rings protect seals from extruding into equipment clearances while under pressure. Used in conjunction with a seal or O-Ring, they are available in various extrusion-resistant materials and are located on the back side or low-pressure side of the sealing element they are supporting.

Profile	Description
R9K	Machined, rectangular profile, rod design
R9KD	Machined, triangular profile used with rod seal
R9K2	Machined, custom profile designed for distinct rod seal design
P9KD	Machined, triangular profile used with distinct piston seal design
P9K2	Machined, custom profile used with distinct piston seal design
ORB	Machined, custom profile used in combination with an O-Ring
P9K	Machined, rectangular profile, piston design

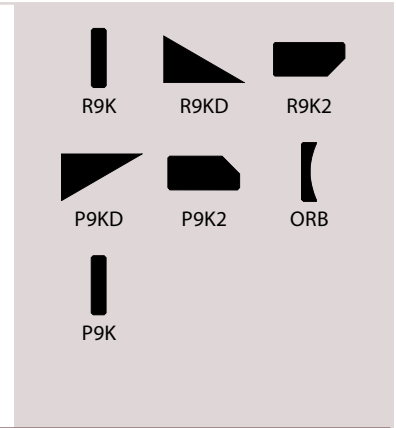

16K, 17K HYDRAULIC WEAR RING STRIPS

Wear ring strips are the economical solution to costly cylinder remachining and repairs and are suitable for use on rams or pistons in reciprocating applications. These split, replaceable wear rings prevent metal-to-metal contact of moving parts and help prolong equipment life.

Profile	Description
16K	Molded continuous coil form for metric sizes used for rod and piston applications
17K	Molded continuous coil form for inch sizes used for rod and piston applications

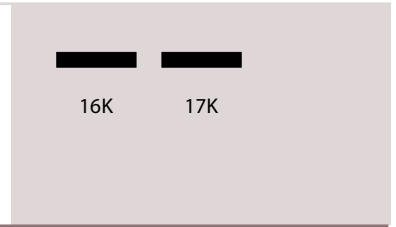

18K/19K/ WR WEAR RINGS

Wear rings are the solution to costly cylinder remachining and repairs for hydraulic or pneumatic equipment. These split, replaceable wear rings prevent metal-to-metal contact of moving parts and help prolong equipment and seal life. These wear rings reduce radial movement, therefore extending seal, life reducing the risk of reoccurring damage.

Profile	Description
18K	Precision molded, imperial sized wear rings for use in medium- and heavy-duty rod and piston applications; made from glass fiber-reinforced, heat-stabilized nylon
19K	Precision molded, metric-sized wear rings for use in medium- and heavy-duty rod and piston applications; made from glass fiber-reinforced, heat-stabilized nylon
WR	Machined, custom sized wear rings for use in light- to medium-duty rod and piston applications; available in various engineered plastics
R9KL	Machined, L-shaped wear rings for use in light- to medium- duty rod applications; available in various engineered plastics
P9KL	Machined, L-shaped wear rings for use in light- to medium-duty piston applications; available in various engineered plastics
WRTP	Machined, T-shaped wear rings for use in light- to medium-duty piston applications; available in various engineered plastics
WRUP	Machined, U-shaped, contoured wear rings for use in light- to medium-duty piston applications; available in various engineered plastics
WRUR	Machined, U-shaped wear rings for use in light- to medium-duty rod applications; available in various engineered plastics
WRTR	Machined, T-shaped wear rings for use in light- to medium-duty rod applications; available in various engineered plastics

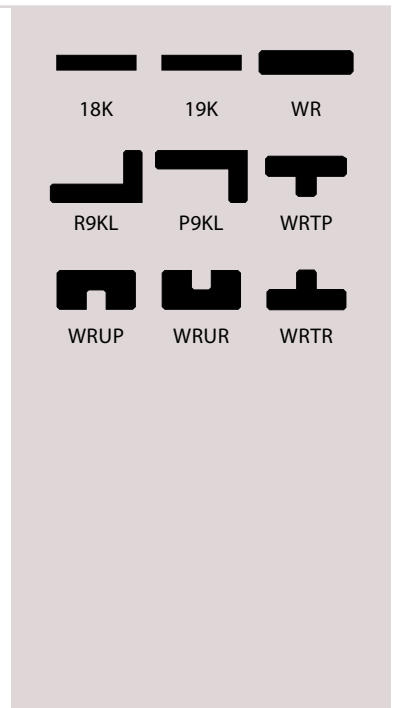

Rotary Seals

R22KN5 BEARING AND GEARBOX PROTECTION

R22KN5 rotary split seals with their robust design are ideal for low-speed, dynamic rotary seal applications exposed to large shaft runout. These seals provide excellent sealing and protective solutions for heavy-duty rotating equipment even in severe application conditions to help prolong bearing and equipment service life.



Profile	Description
R22KN5 ROT	Machined, split rotary seals for protection of housing and bearing areas of low-speed applications

33K BEARING AND GEARBOX PROTECTION

High performance, split lip seals improve on performance of conventional rotary lip seals in bearing and gearbox applications. The split design eliminates the need for equipment disassembly and installation time can be reduced from hours to minutes. Seal available in various PTFE-filled materials with polymer adapters.



Profile	Description
33K	Machined split seal for use in high- or low-speed rotary applications

30K BEARING AND GEARBOX PROTECTION

High performance, continuous seals that improve on performance of conventional rotary lip seals in bearing and gearbox applications. These designs are available in various filled PTFE materials which offer higher speeds, wider temperature range, greater chemical compatibility, and longer life.

Profile	Description
30K	Machined, continuous, dual lip replacement seal for high- or low-speed rotary applications
30KW	Machined, continuous, dual lip replacement seal with built-in wiper design for high- or low-speed rotary applications
30KSW	Machined, continuous, single lip replacement seal with built-in wiper design with limited space for high- and low-speed rotary applications
30KB	Machined, continuous, dual lip replacement seal with metallic stabilizing band for high- and low-speed rotary applications
30KWB	Machined, continuous, dual lip replacement seal with built-in wiper and metallic stabilizing band for high- and low-speed rotary applications
30KP	Machined, continuous, dual lip replacement seal with built-in lip support ring for high-pressure rotary applications

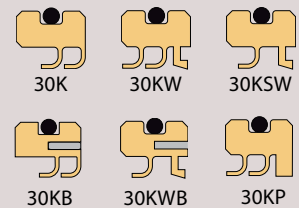

50K BEARING AND GEARBOX PROTECTION

50K face seals are high performance face seals that are used in heavy-duty, dynamic rotary seal applications. These seals protect against ingress of solid particles, dust, and fluids thus protecting housing and bearing areas. 50K is used as a secondary seal for additional protection in combination with other Chesterton rotary seals, which are in the primary seal position.

Profile	Description
50KA	Molded, rotary face seals with cross section profile that varies according to shaft diameter
50AX	Molded, rotary face seal with longer lip for heavy duty applications
50KL	Molded, rotary face seal with narrow axial cross section fit to compression arrangements
50KE	Molded, rotary face seal with special lip for high performance sealing
50KRME	Molded, rotary face seal with built-in housing for radial retention metal clamp



51K BEARING AND GEARBOX PROTECTION

51K seals are high performance radial seals used in heavy-duty, dynamic rotary seal applications. These seals provide long-lasting sealing and superior protection against ingress of solid particles, dust, and fluids and protect bearing houses and gearboxes across the heavy industries, even in the most hostile working environments.



Profile	Description
51K	Molded, large diameter, rotary seals with fabric reinforced back in solid and split form
51KW	Molded, large diameter, rotary seals with special lip profile to withstand high pressure up to 0.4 MPa (60psi)—solid form only
51KHP	Molded, large diameter, rotary seals with additional circumferential groove for lubrication
51KL	Molded, large diameter, rotary seals with additional dust lip in solid and split form

52K BEARING AND GEARBOX PROTECTION

52K seals are high performance radial seals used in heavy-duty, dynamic rotary seal applications. These seals provide long-lasting sealing and superior protection against ingress of solid particles, dust, and fluids and protect bearing houses and gearboxes across the heavy industries, even in the most hostile working environments.

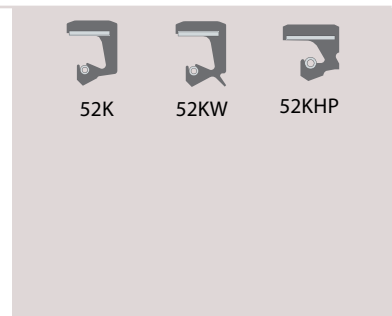

Profile	Description
52K	Molded, large diameter, rotary seals with flexible metal stiffener ring in solid form only
52KW	Molded, large diameter, rotary seals with special lip profile to withstand high pressure up to 0.4 MPa (60psi)
52KHP	Molded, large diameter, rotary seals with additional dust lip

53K BEARING AND GEARBOX PROTECTION

53K seals are high performance radial seals that are used in heavy-duty, dynamic rotary seal applications. These seals provide long-lasting sealing and protective solutions that withstand high speed and large misalignment of shafts and rolls in heavy industry.



Profile	Description
53K	Molded, large diameter, rotary seals with garter-finger spring system
53KW	Molded, large diameter, rotary seals with special, optimized lip interference for high-speed applications
53KHP	Molded, large diameter, rotary seals with special, optimized lip interference for ultra-high-speed applications
53KL	Molded, large diameter, rotary seals with garter-finger spring system and additional dust lip
53KLHS	Molded, large diameter, rotary seals with integrated (vulcanized) PTFE lip tip
53KLPT	Molded, large diameter, rotary seals with garter-finger spring system and special, robust lip profile to withstand high pressure up to 0.1 MPa (15 psi)

KAPLAN BEARING AND GEARBOX PROTECTION

Kaplan Runner Blade Trunnion Split Seals create positive, leak-free sealing systems that will improve sealing and reliability of runner blades to meet environmental control requirements. These seals provide long-lasting sealing and protective solutions for Kaplan turbine runners and can withstand severe application conditions.



KAPLAN SA



KAPLAN DA

Profile	Description
KAPLAN SA	Machined, split rotary seals for Kaplan Turbine Runner Blades, single-acting, in back-to-back configuration, in solid or split form
KAPLAN DA	Machined, split rotary seals for Kaplan Turbine Runner Blades, single ring, double-acting, in solid or split form

30KC POWDERS AND VISCOUS FLUIDS

High performance, polymer cartridge seal for use in dynamic rotary seal applications. This cartridge design uses high performance, filled PTFE materials proven to withstand the high shear rates, frictional heat, and abrasives common when pumping high-viscosity products and powders.



30KC

Profile	Description
30KC	Machined, cartridge design for sealing powders and viscous fluids

14K RESTRICTION BUSHING

Restriction bushings are used in rotary equipment to form a barrier between the sealing device in the stuffing box or pump impeller housing and the pump medium. The bushing helps to prevent suspended abrasive particles from entering the stuffing box area and reduces flush requirements. Individually manufactured from various materials, these restriction bushings provide excellent performance in pumps, agitators, mixers, refiners, and other equipment.



R14K



R14K2P



R14KRBS



R14KPF

Profile	Description
R14K	Machined, polymer, restriction bushing for use in rotary applications
R14K2P	Machined, 2-piece, restriction bushing for large cross sections
R14KRBS	Machined, spacer, used in deep stuffing boxes
R14KPF	Machined, virgin PTFE, restriction bushing for use in rotary applications and for use with aggressive fluids

14KL STUFFING BOX SOLUTIONS

14KL lantern rings are used in rotating equipment to improve lubrication and cooling for packing rings and lip seals by distributing the liquid uniformly around the circumference of the shaft where external lubrication is utilized. A further function of the lantern rings is to keep abrasives and chemicals flushed.



14KL

Profile	Description
14KL	Machined, lantern ring, solid, split or half-ring versions for pump, agitators, mixers, refiners, and other equipment stuffing boxes

Spring Energized Seals

100 SERIES CANTILEVER DESIGN

Cantilever spring energized seals are primarily used in highly dynamic applications for rotary and reciprocating equipment because the spring design allows for high deflection with minimal loading. This is the most popular series for spring energized seal designs due to its unique attributes, which help to maximize seal and hardware life.

Profile	Description
EPS100	Machined, symmetrical U-Cup seal for rod and piston applications
EPS101	Machined, U-Cup rod seal with a positive rake profile on the dynamic lip
EPS103	Machined, symmetrical, U-Cup face seal
EPS105	Machined, symmetrical, flanged, U-Cup rod seal for reciprocating and rotary equipment; flange eliminates seal rotation
EPS107	Machined, U-Cup, piston seal specifically for large cross sections
EPS109	Machined, U-Cup, rod seal specifically for large cross sections
EPS115	Machined, U-Cup, rod and piston seal for low-pressure, reciprocating and rotary equipment
EPS119	Machined, U-Cup, piston seal for low-pressure, reciprocating and rotary equipment
EPS130	Machined, U-Cup, rod and piston seal with support ring for added stability of seal
EPS139	Machined, U-Cup, rod and piston seal to separate media from spring



200 SERIES ELLIPTICAL DESIGN

Elliptical coil spring energized seals are commonly used in rotary, reciprocating, and static applications where hardware tolerances are relatively large or where a miniature seal is required. Elliptical coil spring designs allows for minimal deflection while applying intermediate loads.

Profile	Description
EPS200	Machined, symmetrical, U-Cup seal with a standard lip profile
EPS204	Machined, symmetrical, face seal with a standard lip profile, designed to seal on the inside diameter
EPS205	Machined, symmetrical, flanged U-Cup rod seal for reciprocating and rotary; flange eliminates seal rotation

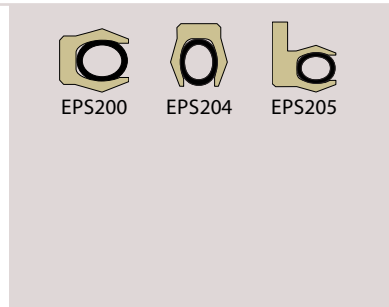

300 SERIES HELICAL DESIGN

Helical wound spring energized seals are primarily used in static applications, slow speeds, extremely low temperatures, and/or infrequent dynamic conditions when friction and wear are secondary concerns. The spring design has excellent loading capabilities with minimal deflection.

Profile	Description
EPS300	Machined, symmetrical, U-Cup seal with a standard lip profile
EPS304	Machined, symmetrical, face seal with a standard lip profile to seal on the inside diameter
EPS305	Machined, symmetrical, flanged U-Cup rod seal for reciprocating and rotary; flange eliminates seal rotation



500 SERIES STACKED SETS

High performance, multi-purpose, stacked V-Ring sets to accommodate hardware with deep stuffing boxes. These stacked sets are used in both rotary and reciprocating applications and are available in solid and split designs, depending upon your application requirements.

Profile	Description
EPS500	Machined, symmetrical, V-Ring set, split or solid for deep stuffing boxes
EPS520	Machined, symmetrical, solid V-Ring set, with spring-loaded primary seal ring for deep stuffing boxes
EPS521	Machined, symmetrical, solid V-Ring set, with spring-loaded primary seal ring and stabilizer ring for deep stuffing boxes
EPS540	Machined, solid V-Ring set, with spring-loaded primary seal ring and O-Ring on static side for deep stuffing boxes

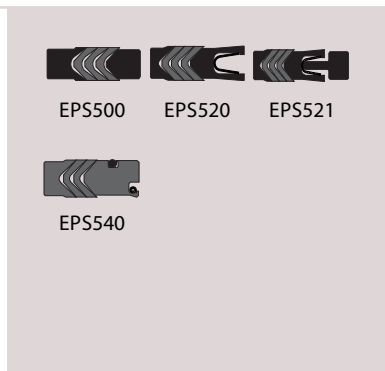

600 SERIES CONTINUOUS CONTACT SPRING DESIGN

Continuous contact, robust, spring energized seals are primarily used where very high axial loading is required for challenging static and slow rotary, oscillating applications. This design is best utilized in difficult static sealing applications such as gas, cryogenic temperatures, and vacuum. This spring design can also be used in dynamic applications where high torque and clamping forces are presented.

Profile	Description
EPS600	Machined, symmetrical U-Cup design for radial inner diameter sealing
EPS601	Machined, symmetrical U-Cup design for radial outer diameter sealing

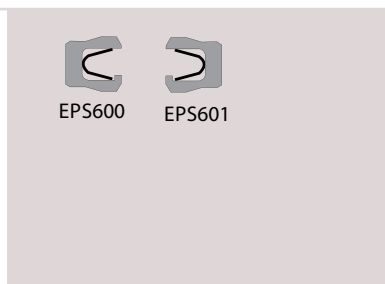

Recommended Seal Sizes and Standard Housing Dimensions

When selecting a seal, it is important to use an appropriate seal cross section and height according to hardware diameters of either bore or rod. The tables below give recommended seal cross section and height ranges used for Chesterton products and for standard housing dimensions.

Table 1 and 2 recommendations can be applied to common industry applications for many U-Cup-type seals. For seal stability, the recommended seal height should be approximately 50% larger than the cross section.

U-Cup Seals (22K, 22KE, 22KAER, 22KEAER, 22KN)



TABLE 1 – METRIC

Diameter Range mm		Cross Section Range mm	Height Range mm
Min	Max	Min – Max	Min – Max
–	25	3.00 – 4.00	5.00 – 6.00
>25	50	3.00 – 5.00	5.00 – 7.00
>50	100	4.00 – 7.00	6.00 – 11.00
>100	150	5.00 – 10.00	7.00 – 14.00
>150	200	6.00 – 12.00	10.00 – 19.00
>200	300	10.00 – 16.00	14.00 – 19.00
>300	1250+	12.00+	19.00+

TABLE 2 – INCH

Diameter Range inch		Cross Section Range inch	Height Range inch
Min	Max	Min – Max	Min – Max
–	1.000	0.125 – 0.156	0.187 – 0.250
>1.000	2.000	0.125 – 0.187	0.187 – 0.281
>2.000	4.000	0.156 – 0.281	0.250 – 0.437
>4.000	6.000	0.187 – 0.375	0.281 – 0.562
>6.000	8.000	0.250 – 0.500	0.375 – 0.750
>8.000	12.000	0.375 – 0.625	0.562 – 0.937
>12.000	48.000+	0.500+	0.750+

Rod seal: Cross section (S) = (D₁-d)/2, Piston seal: Cross section (S) = (D-d)/2

Tables 3 and 4, and Tables 5 and 6 recommendations can be applied to common industry applications for many cap-type seals.

Rod Cap Seals (RCCS, RCCS1, RCCS2, RCCS3, RCCS4)



TABLE 3 – METRIC

Rod Diameter Range mm		Rod Seal Groove Diameter	Seal Groove Height	Seal Cross Section	O-Ring Cross Section
Min	Max	D ₁ H8 mm	L (+200/-0) mm	C/S mm	OR mm
3	7.9	d + 4.9	2.2	2.45	1.78
8	18.9	d + 7.3	3.2	3.65	2.62
19	37.9	d + 10.7	4.2	5.35	3.53
38	199.9	d + 15.1	6.3	7.55	5.33
200	255.9	d + 20.5	8.1	10.25	6.99
256	649.9	d + 24.0	8.1	12	6.99
650	999.9	d + 27.3	9.5	13.65	8.40
1,000+	–	d + 27.3	9.5	13.65	8.40

TABLE 4 – INCH

Rod Diameter Range inch		Rod Seal Groove Diameter	Seal Groove Height	Seal Cross Section	O-Ring Cross Section
Min	Max	D ₁ H8 inch	L (+200/-0) inch	C/S inch	OR inch
0.118	0.311	d + .193	0.087	0.096	0.070
0.315	0.744	d + .287	0.126	0.144	0.103
0.748	1.492	d + .421	0.165	0.211	0.139
1.496	7.870	d + .594	0.248	0.297	0.210
7.874	10.075	d + .807	0.319	0.404	0.275
10.079	25.587	d + .945	0.319	0.472	0.275
25.591	39.366	d + 1.075	0.374	0.537	0.331
39.370 +	–	d + 1.075	0.374	0.537	0.331

Rod seal: Cross-section (S) = (D₁-d)/2

Piston Cap Seals (PCCS, PCCS1, PCCS2, PCCS3, PCCS4)



TABLE 5 – METRIC

Bore Diameter Range mm		Piston Seal Groove Diameter	Seal Groove Height	Seal Cross Section	O-Ring Cross Section
Min	Max	D ₁ H8 mm	L (+200/-0) mm	C/S mm	OR mm
8	14.9	D - 4.9	2.2	2.45	1.78
15	39.9	D - 7.5	3.2	3.75	2.62
40	79.9	D - 11	4.2	5.5	3.53
80	132.9	D - 15.5	6.3	7.75	5.33
133	329.9	D - 21	8.1	10.5	6.99
330	669.9	D - 24.5	8.1	12.25	6.99
670	1,000	D - 28	9.5	14	8.40
1,000+	-	D - 28	9.5	14	8.40

TABLE 6 – INCH

Bore Diameter Range inch		Piston Seal Groove Diameter	Seal Groove Height	Seal Cross Section	O-Ring Cross Section
Min	Max	D ₁ H8 inch	L (+200/-0) inch	C/S inch	OR inch
0.118	0.311	D - .193	0.087	0.096	0.070
0.315	0.744	D - .295	0.126	0.148	0.103
0.748	1.492	D - .433	0.165	0.217	0.139
1.496	7.870	D - .610	0.248	0.305	0.210
7.874	10.075	D - .827	0.319	0.413	0.275
10.079	25.587	D - .965	0.319	0.482	0.275
25.591	39.366	D - 1.102	0.374	0.551	0.331
39.370+	-	D - 1.102	0.374	0.551	0.331

Piston seal: Cross section (S) = (D-d)/2

Tables 7 and 8 recommendations can be applied to common industry applications for many double-acting piston seal incorporating bearing rings.

Double-Acting Piston Compression Seals with Bearing Rings (P20K4, P20K2P4, P20K5, P20K6)



TABLE 7 – METRIC

Bore Diameter Range mm		Piston Seal Groove Diameter	L-shaped Anti-extrusion Ring Leg Inner Diameter	Seal Groove Height	L-shaped Anti-Extrusion Ring Leg Height
Min	Max	D ₁ H9 mm	d ₆ f8 mm	L (+250/-0) mm	L4 mm
20	49.9	D - 10	D - 3	2.45	10.25
50	79.9	D - 15	D - 4	3.75	14
80	149.9	D - 20	D - 5	5.5	18
155	399.9	D - 25	D - 6	7.75	23
400	749.9	D - 30	D - 8	10.5	25
750	-	D - 40	D - 8	14	27

TABLE 8 – INCH

Bore Diameter Range inch		Piston Seal Groove Diameter	L-shaped Anti-extrusion Ring Leg Inner Diameter	Seal Groove Height	L-shaped Anti-extrusion Ring Leg Height
Min	Max	D ₁ H9 inch	d ₆ f8 inch	L (+.01/-0) inch	L ₄ inch
0.787	1.965	D - .394	D - .118	0.096	0.404
1.969	3.146	D - .591	D - .157	0.148	0.551
3.150	5.902	D - .787	D - .197	0.217	0.709
6.102	15.744	D - .984	D - .236	0.305	0.906
15.748	29.524	D - 1.181	D - .315	0.413	0.984
29.528	-	D - 1.575	D - .315	0.551	1.063

Rod seal: Cross section (S) = (D₁-d)/2

Tables 9 and 10 recommendations can be applied to common industry applications for many single-acting rod V-Ring Sets.

Rod V-Ring Set (R28K, R28K1)



TABLE 9 – METRIC

Rod Diameter Range mm		Stuffing Box Bore	Working Stuffing Box Height	Seal Cross Section
Min	Max	D ₁ H9 mm	L ₁ (+250/-0) mm	C/S mm
10	39.9	d + 10	16	5
40	74.9	d + 15	25	7.5
75	149.9	d + 20	32	10
150	199.9	d + 25	40	12.5
200	300	d + 30	50	15
300	-	d + 40	64.5	20

TABLE 10 – INCH

Rod Diameter Range inch		Stuffing Box Bore	Working Stuffing Box Height	Seal Cross Section
Min	Max	D ₁ H9 inch	L ₁ (+250/-0) inch	C/S inch
0.394	1.571	d + .394	0.630	0.197
1.575	2.949	d + .591	0.984	0.295
2.953	5.902	d + .787	1.260	0.394
5.906	7.870	d + .984	1.575	0.492
7.874	11.811	d + 1.181	1.969	0.591
11.811	-	d + 1.575	2.539	0.787

For applications operating outside of typical industry conditions, it is strongly advised to consult Engineering to determine if these ranges are appropriate.

The listed dimensions are suggestions for standard housing dimensions only. Chesterton utilizes a machining process for manufacturing of seal component, which allows the flexibility to create any size based on equipment dimensions and for any non-standard housing as well.

Standard Fits and Tolerances Data Chart

Fits and Tolerances Based on ISO 286-1

ISO 286-1 International Standard is a geometrical product specification (GPS) standard. These ISO standard tolerance classes are used to define an acceptable size range in the manufacturing or reworking of equipment. The chart below shows generally accepted industry standards for hydraulic and pneumatic equipment. However, caution must be observed; these values may not pertain to all applications.

A tolerance class is combined with a basic size to determine the allowable range. For example, a 420 mm bore with a tolerance class of H9, i.e., 420 H9, would have a basic size and tolerance of 420 +155/0 which equals 420,15 to 420,00 mm allowable range of size.

Consult with application engineering for suitability and use of this table.

Diameter Range Basic Size mm*(inch)		Tolerance (Rod based)	Tolerance (Rod based)	Tolerance (Rod based)	Tolerance (Rod based)	Tolerance (Rod based)	Tolerance (Hole based)	Tolerance (Hole based)	Tolerance (Hole based)	Tolerance (Hole based)	Tolerance (Hole based)
Over	Up-to (included)	f8	f11	h8	h9	h10	F8	F11	H8	H9	H10
3 (0.118)	6 (0.236)	-10/-28 (-.0004/-.001)	-10/-85 (-.0004/-.003)	0/-18 (0/-.0007)	+0/-30 (+0/-.001)	0/-48 (0/-.002)	+28/+10 (+.001/+0.004)	+85/+10 (+.003/+0.004)	+18/0 (+.0007/0)	+30/-0 (+.001/-0)	+48/0 (+.002/0)
6 (0.236)	10 (0.394)	-13/-35 (-.0005/-.001)	-13/-103 (-.0005/-.004)	0/-22 (0/-.001)	+0/-36 (+0/-.001)	0/-58 (0/-.002)	+35/+13 (+.001/+0.005)	+103/+13 (+.004/+0.005)	+22/0 (+.001/0)	+36/-0 (+.0010/-0)	+58/0 (+.002/0)
10 (0.394)	18 (0.709)	-16/-43 (-.001/-0.002)	-16/-126 (-.001/-0.005)	0/-27 (0/-.001)	+0/-43 (+0/-.002)	0/-70 (0/-.003)	+43/+16 (+.002/+0.001)	+126/+16 (+.005/+0.001)	+27/0 (+.001/0)	+43/-0 (+.002/-0)	+70/0 (+.003/0)
18 (0.709)	30 (1.181)	-20/-53 (-.001/-0.002)	-20/-150 (-.001/-0.006)	0/-33 (0/-.001)	+0/-52 (+0/-.002)	0/-84 (0/-.003)	+53/+20 (+.002/+0.001)	+150/+20 (+.006/+0.001)	+33/0 (+.001/0)	+52/-0 (+.002/-0)	+84/0 (+.003/0)
30 (1.181)	50 (1.968)	-25/-64 (-.001/-0.003)	-25/-185 (-.001/-0.007)	0/-39 (0/-.002)	+0/-62 (+0/-.002)	0/-100 (0/-.004)	+64/+25 (+.003/+0.001)	+185/+25 (+.007/+0.001)	+39/0 (+.001/0)	+62/-0 (+.002/-0)	+100/0 (+.004/0)
50 (1.968)	80 (3.15)	-30/-76 (-.001/-0.003)	-30/-220 (-.001/-0.009)	0/-46 (0/-.002)	+0/-74 (+0/-.003)	0/-120 (0/-.005)	+76/+30 (+.003/+0.001)	+220/+30 (+.009/+0.001)	+46/0 (+.002/0)	+74/-0 (+.003/-0)	+120/0 (+.005/0)
80 (3.15)	120 (4.724)	-36/-90 (-.001/-0.004)	-36/-256 (-.001/-0.010)	0/-54 (0/-.002)	+0/-87 (+0/-.003)	0/-140 (0/-.006)	+90/+36 (+.004/+0.001)	+256/+36 (+.010/+0.001)	+54/0 (+.002/0)	+87/-0 (+.003/-0)	+140/0 (+.006/0)
120 (4.724)	180 (7.086)	-43/-106 (-.002/-0.004)	-43/-293 (-.002/-0.011)	0/-63 (0/-.003)	+0/-100 (+0/-.004)	0/-160 (0/-.006)	+106/+43 (+.004/+0.002)	+293/+43 (+.011/+0.002)	+63/0 (+.003/0)	+100/-0 (+.004/-0)	+160/0 (+.006/0)
180 (7.086)	250 (9.842)	-50/-122 (-.002/-0.005)	-50/-340 (-.002/-0.013)	0/-72 (0/-.003)	+0/-115 (+0/-.004)	0/-185 (0/-.007)	+122/+50 (+.005/+0.002)	+340/+50 (+.013/+0.002)	+72/0 (+.003/0)	+115/-0 (+.004/-0)	+185/0 (+.007/0)
250 (9.842)	315 (12.401)	-56/-137 (-.002/-0.005)	-56/-376 (-.002/-0.015)	0/-81 (0/-.003)	+0/-130 (+0/-.005)	0/-210 (0/-.008)	+137/+56 (+.005/+0.002)	+376/+56 (+.015/+0.002)	+81/0 (+.003/0)	+130/-0 (+.005/-0)	+210/0 (+.008/0)
315 (12.401)	400 (15.748)	-62/-151 (-.002/-0.006)	-62/-422 (-.002/-0.017)	0/-89 (0/-.004)	+0/-140 (+0/-.005)	0/-230 (0/-.009)	+151/+62 (+.002/+0.002)	+422/+62 (+.017/+0.002)	+89/0 (+.004/0)	+140/-0 (+.005/-0)	+230/0 (+.009/0)
400 (15.748)	500 (19.685)	-68/-165 (-.003/-0.007)	-68/-468 (-.003/-0.018)	0/-97 (0/-.004)	+0/-155 (+0/-.006)	0/-250 (0/-.010)	+165/+68 (+.007/+0.003)	+468/+68 (+.018/+0.003)	+97/0 (+.004/0)	+155/-0 (+.006/-0)	+250/0 (+.010/0)
500 (19.685)	630 (24.803)	-76/-186 (-.003/-0.007)	-76/-516 (-.003/-0.020)	0/-110 (0/-.004)	+0/-175 (+0/-.007)	0/-280 (0/-.011)	+186/+76 (+.007/+0.003)	+516/+76 (+.020/+0.003)	+110/0 (+.004/0)	+175/-0 (+.007/-0)	+280/0 (+.011/0)
630 (24.803)	800 (31.496)	-80/-205 (-.003/-0.008)	-80/-580 (-.003/-0.023)	0/-125 (0/-.005)	+0/-200 (+0/-.008)	0/-320 (0/-.012)	+205/+80 (+.008/+0.003)	+580/+80 (+.023/+0.003)	+125/0 (+.005/0)	+200/-0 (+.008/-0)	+320/0 (+.012/0)
800 (31.496)	1000 (39.37)	-86/-226 (-.003/-0.009)	-86/-646 (-.003/-0.025)	0/-140 (0/-.006)	+0/-230 (+0/-.009)	0/-360 (0/-.014)	+226/+86 (+.009/+0.003)	+646/+86 (+.025/+0.003)	+140/0 (+.006/0)	+230/-0 (+.009/-0)	+360/0 (+.014/0)
1000 (39.37)	1250 (49.213)	-98/-263 (-.004/-0.010)	-98/-758 (-.004/-0.030)	0/-165 (0/-.007)	+0/-260 (+0/-.010)	0/-420 (0/-.016)	+263/+98 (+.010/+0.004)	+758/+98 (+.030/+0.004)	+165/0 (+.007/0)	+260/-0 (+.010/-0)	+420/0 (+.016/0)
1250 (49.213)	1600 (62.992)	-110/-305 (-.004/-0.012)	-110/-890 (-.004/-0.035)	0/-195 (0/-.008)	+0/-310 (+0/-.012)	0/-500 (0/-.020)	+305/+110 (+.012/+0.004)	+890/+110 (+.035/+0.004)	+195/0 (+.008/0)	+310/-0 (+.012/-0)	+500/0 (+.020/0)
1600 (62.992)	2000 (78.74)	-120/-350 (-.005/-0.014)	-120/-1040 (-.005/-0.041)	0/-230 (0/-.009)	+0/-370 (+0/-.015)	0/-600 (0/-.023)	+350/+120 (+.014/+0.005)	+1040/+120 (+.041/+0.005)	+230/0 (+.009/0)	+370/-0 (+.015/-0)	+600/0 (+.023/0)

*mm tolerance values given in μmm (.001 mm)

Application of ISO Standards Fits and Tolerances

The examples below illustrate how fits and tolerances can be applied to dimensioning one or more components of the cylinder for metric and inch sizes.

Tolerance Recommendations

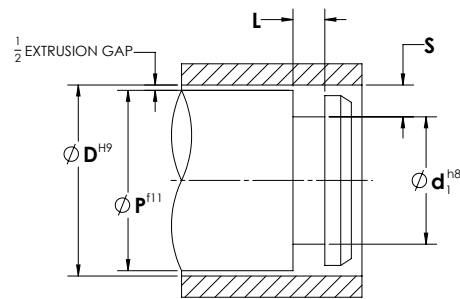
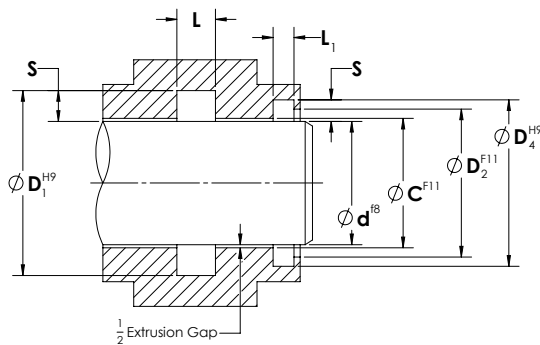

ROD APPLICATION

Dimensions	Rod Seal Profile Group			
	U-Cups	Cap Seals	Compression Seals	Stacked Sets
d	f8	f8	f8	f8
D ₁	H10	H8	H8	H9
C	F11	F11	F11	F11
L	+380/-0 (+.015/-0)	+200/-0 (+.008/-0)	+250/-0 (+.01/-0)	-
L ₃	-	-	-	+250/-0 (+.01/-0)

mm tolerances values given in μmm (.001 mm)

PISTON APPLICATION

Dimensions	Piston Seal Profile Group				
	U-Cups	Cap Seals	Compression Seals	Stacked Sets	Piston Cup
D	H9	H8	H8	H10	H10
d ₁	h10	h8	h9	h8	-
d ₄	-	-	-	-	f11
d ₅	f11	-	-	-	-
d ₆	-	-	f8	-	-
CH	-	-	-	-	h10
P	f11	f11	f11	f11	-
L	+380/-0 (+.015/-0)	+200/-0 (+.008/-0)	+250/-0 (+.01/-0)	-	+100/-0 (+.004/-0)
L ₄	-	-	+100/-0 (+.004/-0)	-	-
L ₃	-	-	-	+250/-0 (+.01/-0)	-

mm tolerances values given in μmm (.001 mm)

Dimensions	Wiper Profile Group			
	Standard Wiper	Canned Wiper	Double Acting Wiper	WCCS Wiper
d	f8	f8	f8	f8
D ₄	H9	H8	H10	H9
D ₂	H10	-	H10	H10
C	F11	F11	F11	F11
L ₁	+250/-0 (+.01/-0)	+250/-0 (+.01/-0)	+380/-0 (+.015/-0)	+200/-0 (+.008/-0)

mm tolerances values given in μmm (.001 mm)

Examples

Bore Dimensioning

300,00 mm bore with H9 tolerance

$$D^{H9} = 300,00 \text{ mm } +130/-0$$

Allowable size range = 300.13 – 300.00mm

Piston Diameter Running Clearance

Piston diameter P to fit 300,00 mm bore

$$P^{F11} = 300,00 -56/-376 \text{ mm}$$

Allowable size range = 299.94 – 299.62mm

Piston Seal Groove

300,00 mm bore, piston seal cross section S = 12,00mm

$$= 300,00 - (2 \times 12,00) = 276,00 +0/-130$$

Allowable size range = 276.00 – 275.87mm

Rod Dimensioning

3.00" rod with h9 tolerance

$$d^{f8} = 3.00" - .0012/- .003$$

Allowable size range = 2.997 – 2.9988"

Gland Inside Diameter Running Clearance

Gland inside diameter to fit 3.00" rod

$$C^{F11} = 3.00 + .009/+ .001"$$

Allowable size range = 3.009 – 3.001"

Rod Seal Groove

3.00 inch rod, rod seal cross section S = .250" d₁ = D – (2 x S)

with h9 tolerance D₄ = 3.000 + (2 x .250) with H9 tolerance =

$$3.500 + .003/-0$$

Allowable size range = 3.503 – 3.500"

Extrusion Gap

Note the resultant extrusion gap on the seal support lands should always be within published limits for the seal profile and material used. Reference *Allowable Extrusion Gap Table* for AWC material and profile ratings.

Piston seal: diametrical clearance = D – P

For above bore and piston

Maximum extrusion gap = D_{max} – P_{min}

$$= 300,13 - 299,62 \text{ mm} = 0,51 \text{ mm}$$

Rod seal: diametrical clearance = C – a

For above rod and gland

Maximum extrusion gap = C_{max} – d_{min}

$$= 3.009 - 2.997 = .012"$$

Miscellaneous Hardware Guidelines—Reciprocating

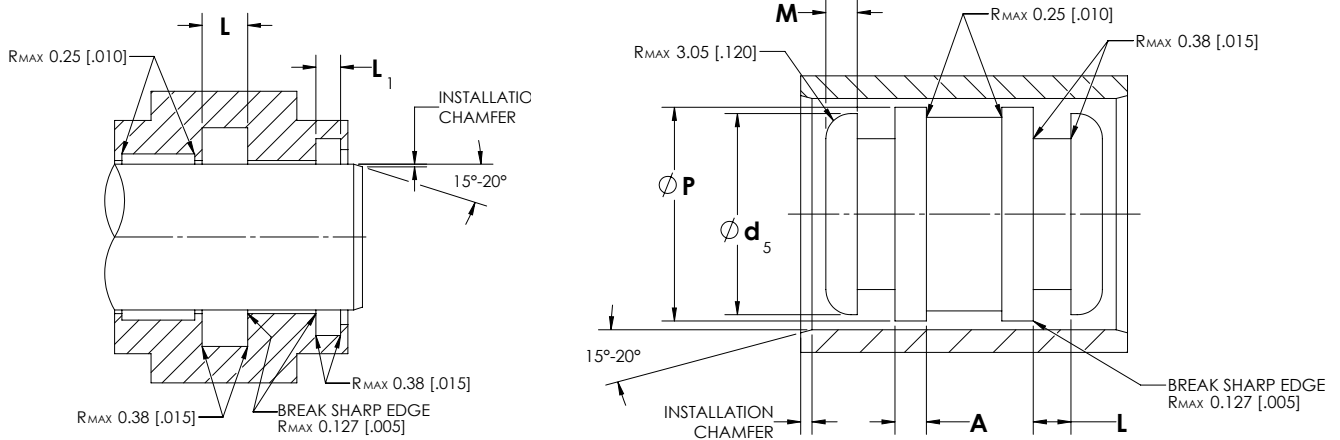

The chart below shows common guidelines for hardware design used to ease installation and to protect against damage to seals for typical industrial hydraulic and pneumatic applications.

Note: Piston landing areas A & M = 3,18 mm (0.125 in) minimum

INSTALLATION CHAMFERS

Seal Cross Section Range (mm/inch)	Chamfer Size (mm/inch)
<3,17 / (0.125)	1,52 / (0.060)
>3,17 - 6,35 / (0.125 - 0.250)	2,03 / (0.080)
>6,35 - 9,53 / (0.250 - 0.375)	2,54 / (0.100)
>9,53 - 12,70 / (0.375 - 0.500)	3,30 / (0.130)
>12,70 - 15,88 / (0.500 - 0.625)	3,94 / (0.155)
>15,88 - 19,05 / (0.625 - 0.750)	4,57 / (0.180)
>19,05 - 22,23 / (0.750 - 0.875)	5,08 / (0.200)
>22,23 - 25,40 / (0.875 - 1.000)	5,59 / (0.220)
> 25,40 / (1.000)	5,84 / (0.230)

The chart below provides recommended groove heights for popular Chesterton seal designs. Piston clearance diameter (d_3) will vary depending on seal profile.

GROOVE HEIGHTS

Profile	Seal Clearance Height $L = H + \text{Clearance}$		Wiper Clearance Height $L_1 = H_2 + \text{Clearance}$		$\varnothing d_5$
	L	Tolerance	L_1	Tolerance	
10K, 22KN, 6K	= Seal height H + 1.50 mm (0.062")	+380/-0 (+.015/-0)	NA		= Seal ID + Sea
22K, 22KE, 23K	= Seal height H + 0.76 mm (0.030")	+380/-0 (+.015/-0)	NA		= Seal ID + Sea
20K, 20KD	= Seal height H + 0.25 mm (0.010")	+250/-0 (+.010/-0)	NA		In case of piston applications: Make equal to $\varnothing P$
Cap Seals	Up to seal height 4 mm: = Seal height + 0.2 mm (0.010") Over seal height 4 mm: = Seal height + 0.40 mm (0.016")	+200 /-0 (+.008/-0)	NA		In case of piston applications: Make equal to $\varnothing P$
11K	= Seal set height H + 3.2 mm (0.125")	+250/-0 (+.010/-0)	NA		NA
8K, 27K	= 0.98 x Seal set height H	+250/-0 (+.010/-0)	NA		NA
28K	= Seal set height H	+250/-0 (+.010/-0)	NA		NA
5K, 21K, 21KH, 5KT5, 21KT5, 21KR	NA		= Wiper flange height + 0.25 mm (0.010")	+250 /-0 (+.010/-0)	NA
5K Combo, 21KC	NA		= Seal height + 1.50 mm (0.062")	+380/-0 (+.015/-0)	NA
W11-E, W12-E	NA		= Wiper flange height + 0.76 mm (0.030")	+250 /-0 (+.010/-0)	NA
WCCS	NA		= Wiper flange height + 0.25 mm (0.010")	+250 /-0 (+.010/-0)	NA

mm tolerances values given in μmm (.001 mm)

Miscellaneous Hardware Guidelines— Rotary and Reciprocating

Seals made of PTFE and engineered plastic compounds, and are usually spring loaded, are much more rigid as compared to elastomeric seals and can easily be stretched or compressed beyond their elastic limits at installation. Therefore, it is recommended to utilize an open housing like the two-piece and snap-in designs shown in the charts below.

The drawings below represent typical gland designs for PTFE/engineered plastic seals. Examples include common two-piece and open (snap-in) housing designs.

Piston Mount:

Two-piece housing

Snap-in housing

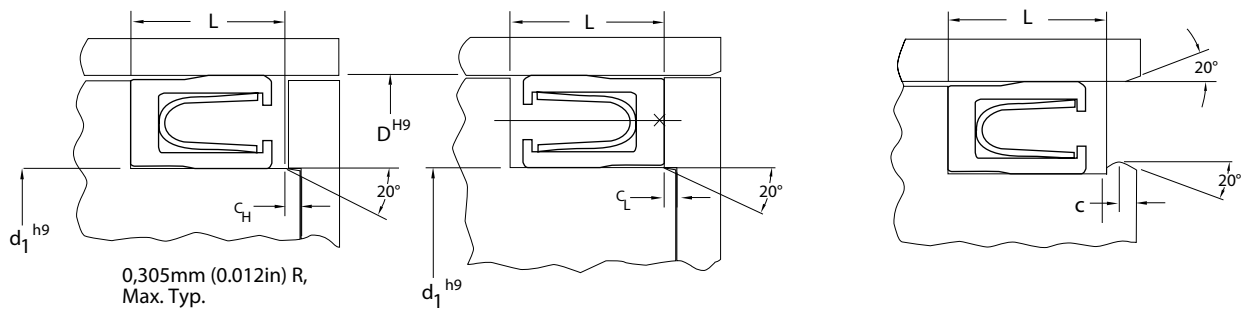

Rod Mount:

Heel first

Lips first

Heel first

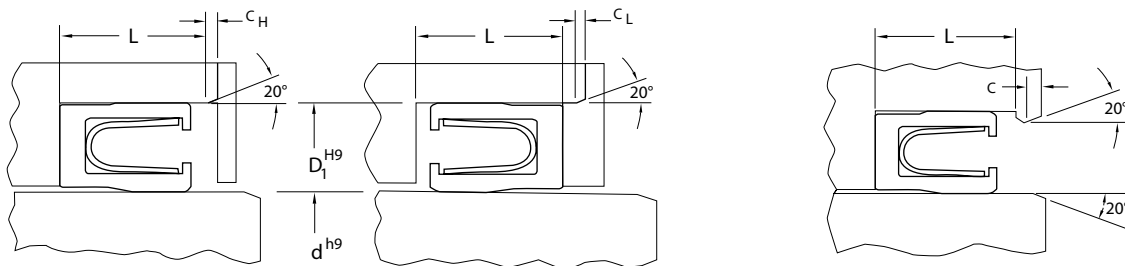

Note: maximum groove radius = 3,50 mm (0.020")

Seal orientation at installation will dictate how much chamfer is required. Seals going into the groove lips first require a longer chamfer to prevent damage during installation. Use the chart below for recommended chamfer.

Seal Cross Section Range mm (inch)	Chamfer C mm (inch)	Installation Chamfer C _H mm (inch)	Installation Chamfer C _L mm (inch)
<2,36 (0.093)	1,14 (0.045)	0,51 (0.020)	1,27 (0.050)
> 2,36 (0.093) – 3,17 (0.125)	1,52 (0.060)	0,76 (0.030)	1,78 (0.070)
> 3,17 (0.125) – 6,35 (0.250)	2,03 (0.080)	1,02 (0.040)	2,29 (0.090)
> 6,35 (0.250) – 9,53 (0.375)	2,54 (0.100)	1,27 (0.050)	3,56 (0.140)
> 9,53 (0.375) – 12,70 (0.500)	3,30 (0.130)	–	–
> 12,70 (0.500) – 5,88 (0.625)	3,94 (0.155)	–	–
> 15,88 (0.625) – 19,05 (0.750)	4,57 (0.180)	–	–
> 19,05 (0.750) – 22,23 (0.875)	5,08 (0.200)	–	–
> 22,23 (0.875) – 25,40 (1.000)	5,59 (0.220)	–	–
> 25,40 (1.000)	5,84 (0.230)	–	–

Note – seals above 2,70mm (0.500 in) cross section will utilize two springs.

Miscellaneous Hardware Guidelines— Replaceable Wear Rings

Functions of Non-metallic Wear Rings

Cylinders are complex, dynamic, and elastic mechanical systems. In addition to the potential side load, the cylinder component's elastic deformation under load can cause deflection as well as angular deviations between the rod and gland and between the piston and cylinder tube. Functions of the non-metallic wear rings are to:

- Create transverse support and longitudinal guide to sliding components
- Enable low friction relative motion between the sliding metallic components
- Enable low wear relative motion between sliding metallic components
- Eliminate metal-to-metal contacts in the cylinders

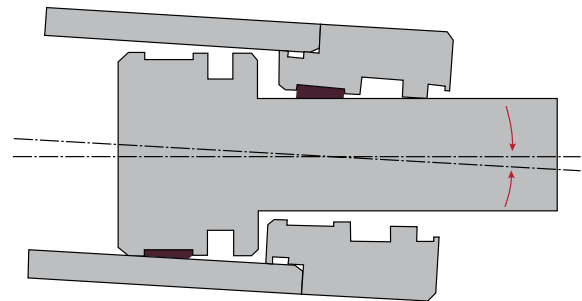

Wear Ring Width Selection

When selecting the guiding width, it is critical to evaluate the transverse loads that the wear rings will have to withstand. Since the system is complex and elastic deformation, deflection, and stretching of the components make the calculation difficult, an assumption-based approach is recommended when we intend to determine the transverse load that has occurred on the cylinders. The engineering rule of thumb says that about 10 – 15% of the hydraulic longitudinal force is applied as transverse load, even in most ideal situation, which can bend the cylinder rods.

The diagram to the right shows the total pressure area (A_p) that the transverse force (F) from a side load will affect. The area A_p is calculated by the $A_p = d \times H_1$ where d is rod diameter with rod wear ring, and H_1 is wear ring height. P_r is the permissible compressive load of the wear ring material.

$$F = P_r \times A_p$$

$$A_p = d \times H_1$$

$$H_1 = \frac{F}{d \times P_r}$$

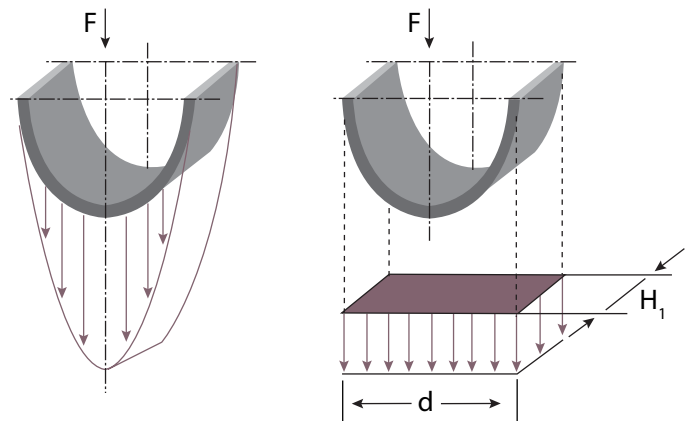

In fact, the pressure distribution is not equally distributed across the area (A_p). That is why it is recommended to use a degradation factor (d_r) that will reduce the calculated load-bearing area and increase the calculated compressive load on the non-metallic wear ring. The assumed load-bearing area (A_L) can be calculated with a degradation factor of 3 as follows:

$$A_L = \frac{A_p}{d_r} = \frac{d \times H_1}{3}$$

The transverse force which occurs can vary within wide ranges and cannot be always calculated exactly in advance. Further we must account for changes in physical properties due to increases in system temperature. For such cases, a safety factor (sf) of at least 2 is recommended to use for calculations. To calculate the proper bearing height, based on the known transverse force:

$$H_1 = \frac{F \times sf}{d \times P_r}$$

where

F = maximum transverse force (N or pound-force)

sf = safety factor

d = rod nominal diameter with rod wear ring (mm or inch)

P_r = permissible compressive load of the wear ring material (N/mm² MPa or psi)

Permissible compressive load (Pr) can be found in the specifications of the different wear ring materials.

Example:

F = 60,000 N

sf = 2

d = 100 mm

16K AWC640 material Pr 100 N/mm² (dynamic at 23°C)

Total = (60,000 Nx2)/(100mmx100N/mm²) = 12 mm

The closest larger standard groove width has to be selected, which is 15 mm in the case of 16K Wear Ring Strip.

To calculate the allowable radial force F, based on known wear ring height:

$$F = \frac{A_L \times P_r}{sf} = \frac{d \times H_1 \times P_r}{3 \times sf}$$

Standard Chesterton wear rings have a rectangular cross section with chamfered edges. The chamfered edges have two functions:

- Serve to facilitate ease of installation when inserting into the cylinder tube or gland
- Protect against the undesired, impermissible edge forces and stresses in the corner radiuses of the wear ring grooves

18K, 19K, and WR wear rings are delivered ready to fit with the gap necessary for their function. Gaps at the ends of the wear rings are required for the following reasons:

- Compensation of the linear expansion of the rings due to effect of the elevated system temperature
- Protect against the build up of intermediate pressure and entrained pressure

Calculation of the Linear Length

16K and 17K wear ring strips are delivered in coils which must be cut to size manually. The length of the ring can be calculated using the following formula:

Rod application: $L = \pi \times (D - S) - G$ (mm or inch)

Piston application: $L = \pi \times (d + S) - G$ (mm or inch), where

L = required length of the wear ring (mm or inch)

d = Rod diameter (mm or inch)

D = Piston diameter (mm or inch)

S = Cross section of the wear ring

π = 3.1415 (constant)

G = Required gap (mm or inch)

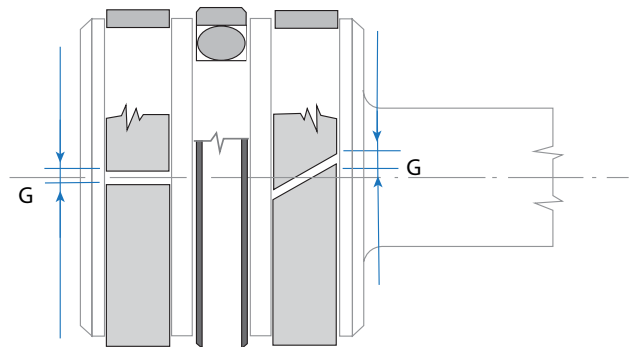
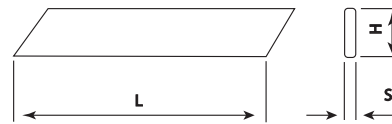

Cutting Instruction		
Outside Diameter mm (inch)	Gap mm (inch)	Tolerance μmm (inch)
> 300 (12.00) < 635 (25.00)	5 (.20)	+/- 0.762 (.003)
> 635 (25.00) < 1,000 (40.00)	7 (.275)	+/- 0.762 (.003)
> 1,000 (40.00)	9 (.355)	+/- 0.762 (.003)

Wear Ring Groove Diameters

The chart below gives dimensional data for hardware clearances and groove design for all Chesterton replaceable wear rings. The use of replaceable wear rings necessitates larger clearance gaps for the prevention of metal to metal contact. Consequently, the resulting extrusion gap will be larger for the seal support land. Always ascertain whether the clearance obtained from this chart is within the allowable ratings for the seal material used.

Piston mount: $d_2 = D - (2 \times S)$ with f8 tolerance

Rod mount: $D_3 = d + (2 \times S)$ with F8 tolerance

Piston and Gland Clearance Diameters

Piston diameter P = Actual bore – “piston to bore clearance” and “tolerance” from chart

Gland inside diameter C = Actual rod + “rod to gland clearance” and “ISO tolerance” from chart

Example 1: 200 mm bore with S = 2.50 mm Example 2: 2.500" rod with S = .125"

$$d_2 = (200,00 - [2 \times 2,50]) - 0.05/-0.115 = 195.00 + 0.005/-0.122$$

$$D_3 = (2.500 + [2 \times .125]) + .003/+0.0012 = 2.75 + .003/+0.0012$$

$$\text{Size range with tolerance} = 194.95 - 194.878 \text{ mm}$$

$$\text{Size range with tolerance} = 2.753 - 2.762''$$

$$P = 200,00 - 0,48 = 199,52 + 0/-,10$$

$$C = 2.500 + .018 = 2.518 + .003/-0$$

$$\text{Size range with tolerance} = 199,52 - 199,42 \text{ mm}$$

$$\text{Size range with tolerance} = 2.521 - 2.518''$$

$$\text{Extrusion gap} = 200 \text{ mm} - 199,88 = 0,22 \text{ mm}$$

$$\text{Extrusion gap} = 2.521 - 2.500 = 0.021''$$

Wear Ring Groove Dimensions							
Dia. Range Basic Size mm (inch)		Piston to Bore Clearance mm (inch)		Rod to Gland Clearance mm (inch)		ISO Tolerance mm (inch)	
Min.	≤ Max.	(D-P)	Tolerance	(C-d)	Tolerance	F8	f8
-	50 (1.968)	.430 (.017)	+0/-.050 (+0/-0.002)	.430 (.17)	+0.050/-0 (+0.002/-0)	+0.064/+0.025 (+0.003/+0.001)	-.025/-.064 (-.009/-0.003)
50 (1.968)	120 (4.724)	.460 (.018)	+0/-.070 (+0/-0.003)	.460 (.018)	+0.070/-0 (+0.003/-0)	+0.090/+0.036 (+0.004/+0.001)	-.036/-.090 (-.001/-0.004)
120 (4.724)	250 (9.842)	.480 (.019)	+0/-.100 (+0/-0.004)	.480 (.019)	+0.100/-0 (+0.004/-0)	+0.122/+0.050 (+0.005/+0.002)	-.050/-.122 (-.002/-0.005)
250 (9.842)	500 (19.685)	.510 (.020)	+0/-.120 (+0/-0.005)	.510 (.020)	+0.120/-0 (+0.005/-0)	+0.165/+0.068 (+0.007/-0.003)	-.068/-.165 (-.003/-0.007)
500 (19.685)	800 (31.496)	.530 (.021)	+0/-.150 (+0/-0.006)	.530 (.021)	+0.150/-0 (+0.006/-0)	+0.205/+0.080 (+0.008/+0.003)	-.080/-.205 (-.003/-0.008)
800 (31.496)	1000 (39.370)	.560 (.022)	+0/-.180 (+0/-0.007)	.560 (.022)	+0.180/-0 (+0.007/-0)	+0.226/+0.086 (+0.009/+0.003)	-.086/-.226 (-.003/-0.009)

mm tolerances values given in mm

Allowable Diametrical Clearance

FIGURE 1

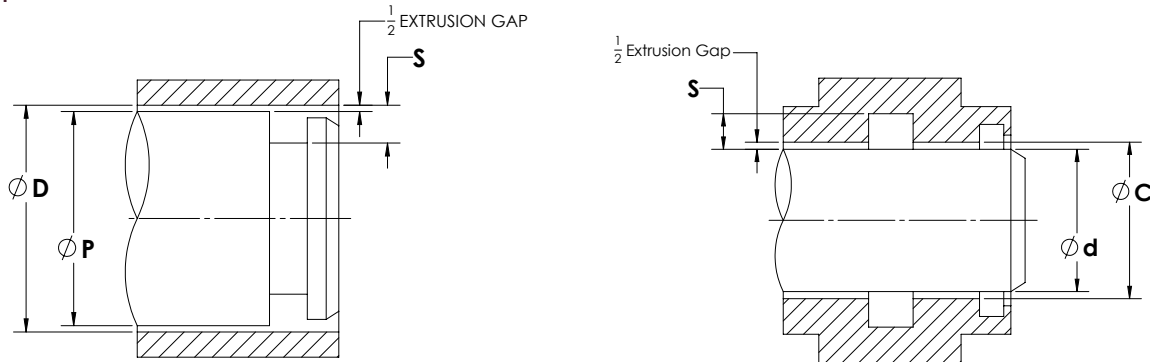

Gap Extrusion

When the seal material is squeezed by fluid pressure into the clearances between components on the unpressurized side, it is called gap extrusion. The dimension of this clearance gap is referred to as the extrusion gap, or "e-gap". The extrusion of the seal is mainly driven by system pressure, as the seal's internal shear stress increases as the system pressure increases. When the shear stress exceeds the physical limit of the seal material it will extrude into the gap. Such overload of the seal material will deteriorate the structural integrity of the seal material and result in leaking and physical destruction of the seal.

The ability of a seal to resist extrusion into the gap (called extrusion resistance) depends on the following factors:

- system operating pressure
- system operating temperature
- size of the clearance gap
- seal material and design (seal materials with greater durometer and stiffness typically have better resistance to gap extrusion)

The actual size of the extrusion gap is determined by the following factors:

- the nominal gap designed into the cylinder (running clearances)
- manufacturing tolerances including diametrical variation and geometrical deviations
- diametrical expansion of the cylinder caused by system pressure
- transverse force caused by deflection and angular
- wear on radial load-bearing surfaces

Because all these factors vary, and because the variances can be cumulative, seal design and material must resist extrusion through the largest gap likely to be encountered at design pressure and temperature.

Extrusion Gap

The maximum clearance gap formed between hardware components must be held to a minimum to prevent seal extrusion and premature failure. See *Figure 1* above for typical rod and piston seal extrusion locations. Reference the following tables for maximum values according to system pressure vs. material used. For clearance gaps beyond the recommended values in the tables, the use of a backup ring is recommended.

**Polyurethanes
AWC800, AWC860**

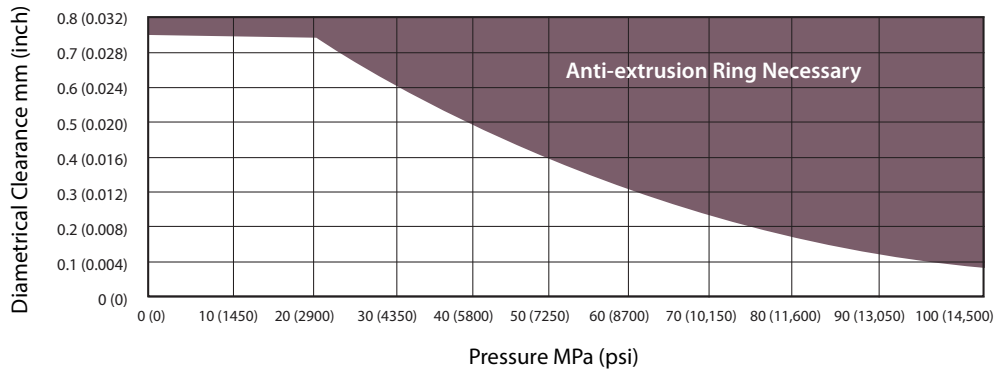

**Polyurethanes
AWC805, AWC825**

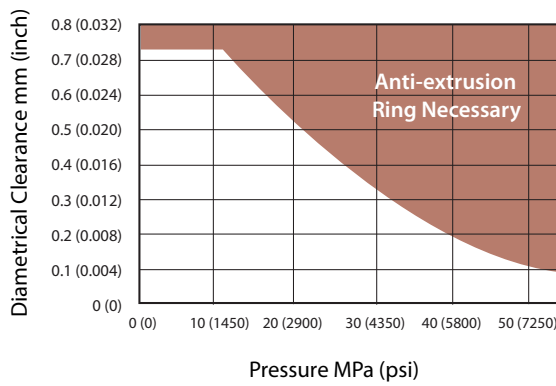

**Polyurethanes
AWC830**

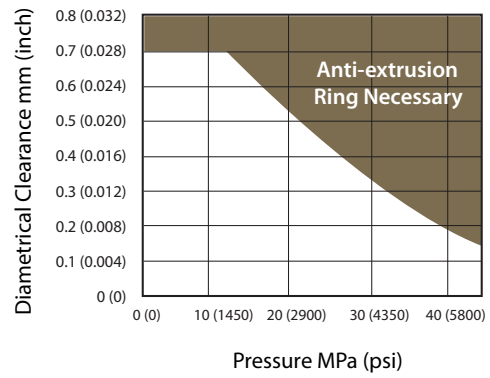

**Polyurethanes
AWC808**

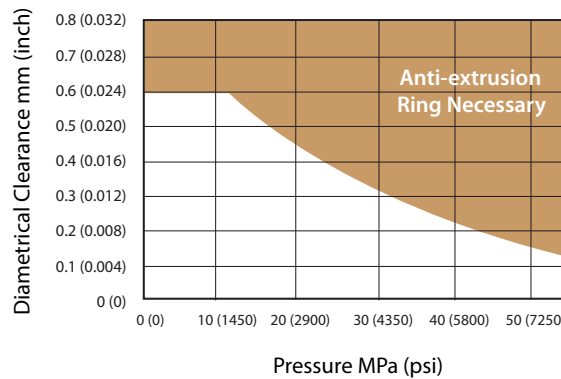

**Engineered Hard Plastics
AWC650, AWC665**

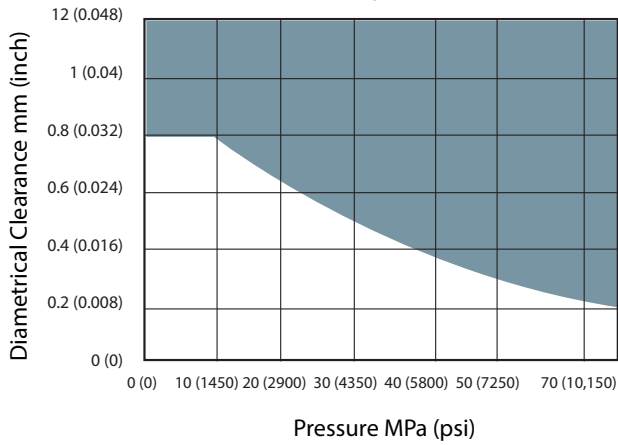

**Engineered Hard Plastics
AWC630, AWC635**

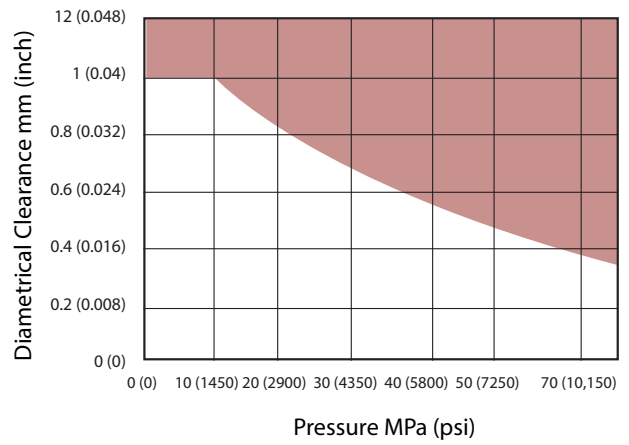

**Fluoroplastics
AWC300, AWC500, AWC520**

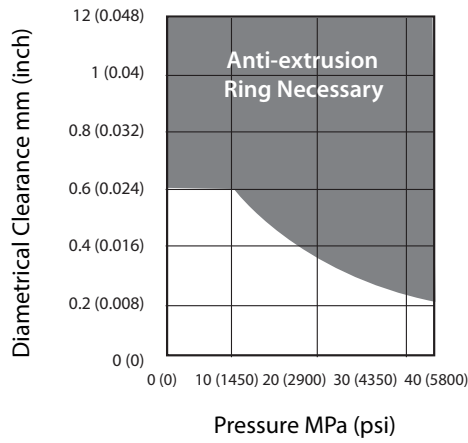

Dynamic Sealing Surface Hardness

Seal components have continuous physical contact with their dynamic mating surfaces. The relative motion/speed and frictional force generate wear on the seal’s dynamic lip contact surfaces and on mating surfaces as well. That is why wear resistance of the seal material and mating surfaces will have influence on the equipment life.

A harder mating surface allows for the use of higher wear-resistant seal material that will increase both the seal and hardware service lives. Softer surfaces require the use of lower wear-resistant seal materials that will not damage the mating hardware surface, but will normally reduce seal life. In the case of harder surfaces the adhesion between the metal component and the seal is reduced which results in longer service life for the seal. A balance between seal material and hardware surface should be met to achieve optimum overall sealing performance and to ensure that the seal is the sacrificial component and not the hardware. *Table 1* shows some of the most popular materials that are used for the manufacturing of cylinder’s and reciprocating equipment’s components. This gives a guideline for their average hardness value ranges.

TABLE 1

Material Grades		Typical Hardness Values Rockwell (HRC)		Properties and Typical Application Areas
		Annealed	Hardened	
Carbon Steel	1.0577 (AISI A738)	8 – 10	20	Excellent machinability and weldability. Hydraulic and pneumatic cylinders for agricultural and farm machinery, hoists, automotive and transport lifting equipment, waste disposal transport, food processing equipment, mechanical tools, and equipment.
	1.1181 (AISI 1034)	8 – 10	40 – 45	Widely used in the fields of ship, vehicle, airplane, guided missile, railway, bridges, pressure vessel, machine tools, and mechanical components with a larger sectional size.
	1.1191 (AISI 1045)	8 – 10	50 – 55	High-strength carbon steel which is mainly used after quenched and tempered. After QT, C45E steel can obtain good comprehensive mechanical properties. Steel is applied to manufacture high-strength moving parts, such as air compressors, piston pumps, heavy duty and general machinery with rolling shafts, connecting rods, worm, rack, or gear.
Alloy Steel	1.5217 (AISI A572)	9 – 10	55 – 60	20MnV6 is a carbon-manganese steel micro alloyed with vanadium, characterized by excellent machinability and weldability, and with high yield and tensile strengths due to the micro alloying effect of the vanadium. 20MnV6 is used extensively by all industry sectors for a wide range of applications utilizing its considerable machinability. Typical applications are chrome plating, cylinders, conveyor rolls, hollow shafts, nuts, and rings.
	1.1303 (AISI 10V45)	20 – 22	50 – 55	Used in hydraulic and pneumatic cylinders that are medium to highly stressed for earth moving, mining, agricultural, waste disposal transport, machine tools, hoists, food processing equipment, compressors, mechanical tools, car jacks, and lifting equipment.
	1.7225 (AISI 4140)	13 – 15	50 – 55	Components with high requirements on toughness. Oil and gas sector, steel industry like collets, connection rods, conveyor pins, stem assemblies, gears, and bearings.
	1.6511 (AISI 4340)	18 – 20	50 – 55	1.6511 steel is a quenched and tempered (Q+T) alloy structural steel that is used for engineering structures. Use when good toughness, and high strength are required, as well as the important conditioning of large size, heavy machinery such as high load of axis, turbine shaft, blade, high load of transmission parts, and fasteners of the crankshaft.
Stainless Steel	1.4305 (AISI 303)	–	19 – 20	Excellent machinability. It is suitable for mass production of components requiring good resistance to atmospheric corrosion and good resistance to many organic and inorganic chemicals. It should not be used in marine environments or coastal environments.
	1.4307 (AISI 304)	–	22 – 23	Good corrosion resistance, impact strength, and formability. The steel has improved machinability. It has good corrosion resistance to uniform corrosion and to many slightly corrosive organic and inorganic chemicals.
	1.4404 (AISI 316)	–	25 – 28	Corrosion-resistant, austenitic stainless steel with good formability. The steel is modified for machining and has very good corrosion resistance.
	1.4125 (AISI 440C)	25 – 27	40 – 45	AISI 440C steel is characterized by good corrosion resistance in mild domestic and industrial environments including fresh water, organic materials, mild acids, and various petroleum products. It has extreme high strength, hardness, and wear resistance when in the hardened and tempered condition. Grade 440C stainless steel is capable of attaining, after heat treatment, the highest strength, hardness, and wear resistance of all the stainless alloys.

Disclaimer: The data and examples are only general recommendations and not a warranty or a guarantee.

Required minimum surface hardness is dependent on operating conditions (velocity, pressure, tribological conditions and work environment conditions and utilized seal materials, components, and their seal systems. Low-speed and/or low-pressure applications require lower surface hardness values while high-speed and/or high-pressure applications require higher surface hardness values. The recommended absolute minimum surface hardness for reciprocating applications is HRC 35. But for optimum performance, the recommended minimum surface hardness value is 50 HRC.

Seal and equipment performance can be improved further by the use of a piston rod of chrome-plated steel. The chrome plating has good sliding properties (reducing friction) and increases the surface hardness further to the range of HRC 60 – 65. Additional improvement can be achieved by hard chrome plating on hardened rod surface, where the hardened surface has a minimum HRC hardness and a hardening depth minimum of 2.5 mm (0.1 inch). *Table 2* summarizes the most common coating and plating methods, which are used in fluid power reciprocating applications.

TABLE 2

Plating or Coating Method		Max Hardness HRC	Recommended Thickness mm (inch)	Corrosion Resistance	Abrasive Affect on Seal Components
Chrome plating	Hard chrome	65	0.02 – 0.127 (0.0008 – 0.005)	Fair	Excessive
	Thin dense chrome	70	0.005 – 0.015 (0.0002 – 0.0006)	Excellent	Moderate
Plasma spray coating	Aluminum oxide	65	0.127 – 0.762 (0.005 – 0.03)	Excellent	Moderate
	Chromium oxide	70	0.127 – 0.762 (0.005 – 0.03)	Excellent	Moderate
High velocity oxygen fuel	Tungsten carbide	75	0.127 – 0.762 (0.005 – 0.03)	Excellent	Moderate
Electroless nickel plating	Nickel as deposited	50	0.0254 – 0.09 (0.001 – 0.0035)	Excellent	Moderate
	Nickel fully hardened	70	0.0254 – 0.09 (0.001 – 0.0035)	Good	Excessive
Eloxation	Aluminum hard anodic oxidation	50	0.025 – 0.2 (0.001 – 0.008)	Excellent	Moderate

Disclaimer: The data and examples are only general recommendations and not a warranty or a guarantee.

Surface Roughness

The irregularity of a machined surface is the result of the machining process including the choice of tool, feed and speed of the tool, machine geometry, and environmental conditions. This irregularity consists of high and low spots machined into a surface by the tool bit or a grinding wheel. These peaks and valleys can be measured and used to define the condition and sometimes the performance of the surface.

The dynamic mating surface properties—such as cylinder bore and piston rod to be sealed— properties of the hydraulic cylinders have great influence on the function, reliability, and service life of the seal components and systems. The mating surface property, is a quality commonly described by surface finish or roughness. Surface roughness is a measure of the irregularities (peaks and valleys) produced on a mating/sealing surface according to the manufacturing process used to create the surface.

Adhering to recommended finish ranges can have a profound effect on seal performance by limiting the effects of friction and reducing abrasive seal wear. An optimal surface texture will have ideal pocket depths that retain lubrication in small enough volumes to provide a thin lubrication film between seal and surface thereby reducing friction and seal wear. If the surface is too rough, it will abrade the seal surface by plowing grooves in it and create a leak path. Alternatively, a surface that is too smooth will increase friction and wear because it does not have the ability to retain enough lubrication to provide a boundary lubrication film.

The parameters for specifying a surface finish are defined in ISO 4287, 4288 and DIN 4762 standards. The parameters are measured

or calculated from the roughness mean line. The most commonly used value is Ra arithmetic average, which is the arithmetic mean deviation of the surface profile (Figure 1). The other characteristics frequently used to describe the surface roughness are Rz, which is a peak-to-valley height and Rmax, which is maximum peak-to-valley height (Figure 2).

$$\text{Calculation of } R_z: R_z = (R_{z1} + R_{z2} + R_{z3} + R_{z4} + R_{z5}) / 5$$

However the Ra, Rz, and Rmax values alone do not describe exactly how the mating surface will affect the seal and how suitable is the mating surface quality for dynamic sealing applications. The Rmr material contact area (or sometimes called material profile bearing length ratio, tp according to ASME 64.1) provides more information about the surface profile characteristics (Figure 3). Ground and polished surfaces will have higher Rmr ratios and lower Ra, Rz, and Rmax values, which provide “seal friendly” surface characteristics. While machined, ground mating surfaces—without polishing—have lower Rmr ratios and higher Ra, Rz and Rmax values, which provide insufficient surface quality for sealing applications. Different surface roughness samples and their material ratio curves with similar Ra and Rz values are shown in Figure 4.

Static surfaces, such as O-Ring groove and mating surfaces or seal groove diameters of dynamic seals, are easier on seals in general. That is why requirements for static surface roughness are less rigorous. Surface roughness value recommendations are distinguished between static and dynamic surfaces. Further surface finish recommendations will vary depending upon the seal material choice as well (see Chart 1).

FIGURE 1 – CALCULATION METHOD OF Ra

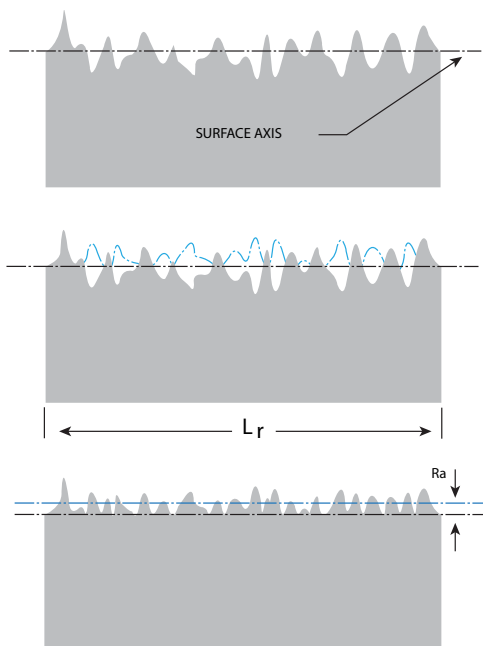

FIGURE 2 – Rz SURFACE VALUE AND CALCULATION OF Rmax

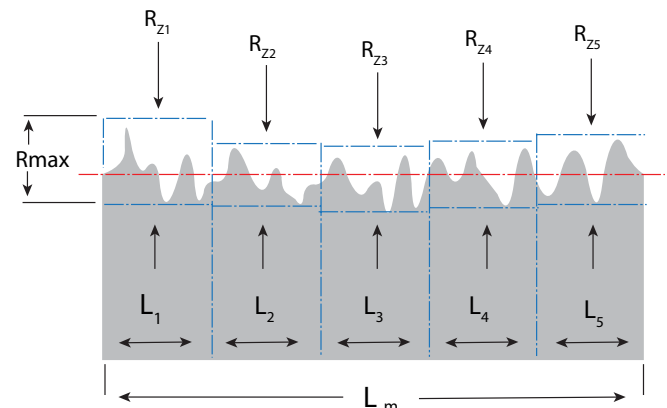

FIGURE 3. SURFACE PROFILE AND ITS MATERIAL RATIO CURVE

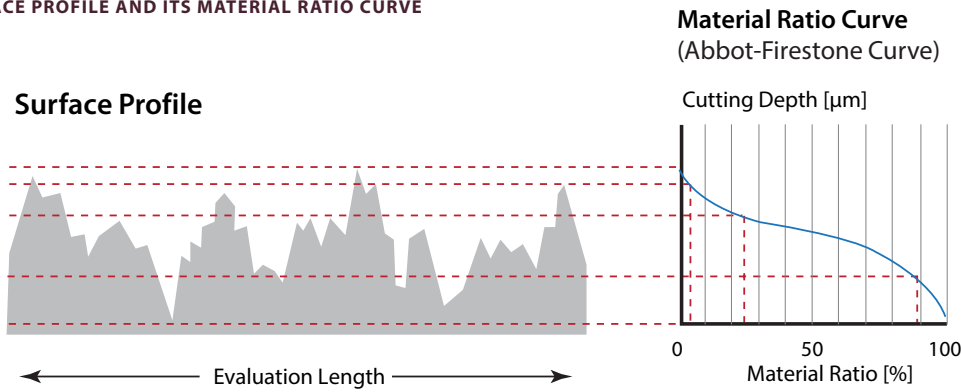

FIGURE 4. SURFACE ROUGHNESS PROFILES AND THEIR MATERIAL RATIO CURVES WITH SIMILAR Ra AND Rz VALUES

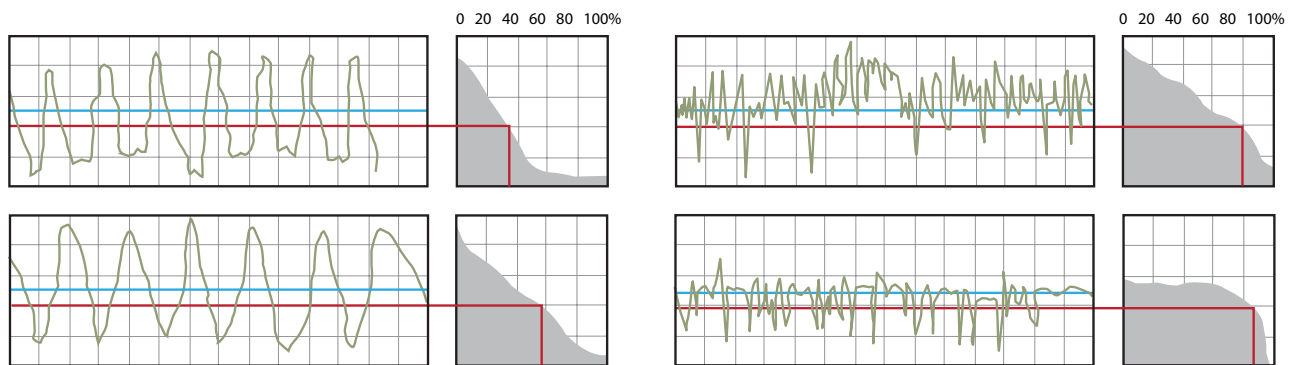

CHART1 - SURFACE ROUGHNESS GUIDELINES

Materials	Surface Roughness Guidelines							
	R _a		R _z		R _{max}		*R _{mr}	
	Dynamic Surface	Static Surface	Dynamic Surface	Static Surface	Dynamic Surface	Static Surface	Dynamic Surface	Static Surface
AWC800, 808, 830, 860	0.20 – 0.61 µm (8 – 24 µin)	max 1.17 µm (46 µin)	1.60 – 4.80 µm (63 – 190 µin)	max 7.0 µm (280 µin)	1.60 – 4.80 µm (63 – 190 µin)	max 7.0 µm (280 µin)	45% – 75%	nil
Low durometer polyurethanes AWC805, 825	0.20 – 1.17 µm (8 – 46 µin)	max 1.42 µm (56 µin)	1.60 – 9.40 µm (63 – 370 µin)	max 10.0 µm (400 µin)	1.60 – 9.40 µm (63 – 370 µin)	max 10.0 µm (400 µin)	45% – 75%	nil
Polyurethanes AWC830	0.20 – 0.61 µm (8 – 24 µin)	max 1.17 µm (46 µin)	1.60 – 4.80 µm (63 – 190 µin)	max 7.0 µm (280 µin)	1.60 – 4.80 µm (63 – 190 µin)	max 7.0 µm (280 µin)	45% – 75%	nil
Elastomers AWC 701, 702, 703, 704, 727, 738, 739, 741, 742, 743, 744, 749, 743, 750, 752, 753, 754, 766, 767, 768	0.10 – 0.3 µm (4 – 12 µin)	max 0.8 µm (32 µin)	0.80 – 2.4 µm (30 – 94 µin)	max 4.8 µm (190 µin)	0.80 – 2.4 µm (30 – 94 µin)	max 4.8 µm (190 µin)	50% – 85%	nil
PTFE Compounds AWC100, 200, 300, 400, 425, 500, 510, 520, 530, 540	0.10 – 0.2 µm (4 – 12 µin)	max 0.80 µm (32 µin)	0.80 – 1.6 µm (30 – 64 µin)	max 6.40 µm (250 µin)	0.80 – 1.6 µm (30 – 64 µin)	max 6.40 µm (250 µin)	60% – 90%	nil
PEEK™ Compounds AWC630, 633, 635	0.10 – 0.40 µm (4 – 16 µin)	max 0.80 µm (32 µin)	0.80 – 3.20 µm (30 – 126 µin)	max 6.40 µm (250 µin)	0.80 – 3.20 µm (30 – 126 µin)	max 6.40 µm (250 µin)	60% – 90%	nil
UHMWPE compounds AWC610, 615, 620, 625	0.10 – 0.40 µm (4 – 16 µin)	max 0.80 µm (32 µin)	0.80 – 3.20 µm (30 – 126 µin)	max 6.40 µm (250 µin)	0.80 – 3.20 µm (30 – 126 µin)	max 6.40 µm (250 µin)	60% – 90%	nil

*R_{mr} values are determined at a cut depth c=0.25xR_z, relative to a reference level (C_{ref}) at 5% material/bearing area.

Operating Temperature Range

TYPICAL OPERATING TEMPERATURE RANGES BY MATERIAL GRADES

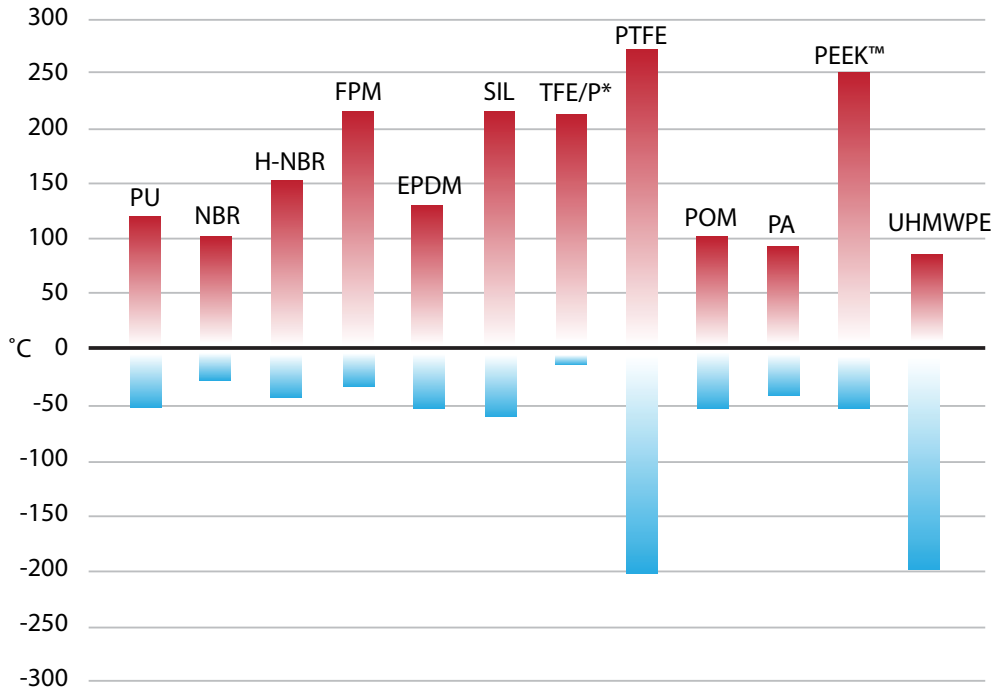

CHESTERTON MATERIALS BY ELASTOMER GROUPS

Material Group	Chesterton Materials
PU	AWC800, AWC805, AWC808, AWC825, AWC830, AWC841, AWC860
NBR	AWC739, AWC741, AWC742, AWC749
H-NBR	AWC738, AWC743, AWC744
FKM	AWC701, AWC702, AWC703, AWC704, AWC715, AWC730
EPDM	AWC752, AWC753, AWC754
VMQ	AWC766, AWC767, AWC768
TFE/P	AWC727
TPE	AWC601
PTFE	AWC100, AWC200, AWC300, AWC400, AWC425, AWC500, AWC510, AWC520, AWC530, AWC540
POM	AWC650
PA	AWC660, AWC663, AWC665
PEEK™	AWC630, AWC663, AWC635
UHMWPE	AWC610, AWC615, AWC620, AWC625

Hydraulic Fluids and Chemical Compatibility

The hydraulic fluid is the common element in any hydraulic system and is selected according to actual operating, environmental, and safety requirements. Quality and cleanliness of the hydraulic fluid are important factors for the operational efficiency, reliability, and service life of the components and the entire system.

Fluids in the hydraulic systems provide several functions that have influence on the system performance:

- Energy transmission by flow of pressurized fluid
- Lubrication of the moving, and sliding components and surfaces in contact (hydraulic cylinder, and valve and pump components including seals)
- Heat removal from high-load areas, transferring through the entire system to the reservoir tank and cooler
- Cleaning the system by carrying wear particles and contaminants to the filters
- Corrosion protection of components

When choosing a hydraulic fluid, the following features are the most important for consideration:

- Viscosity and viscosity index (viscosity temperature behavior of the fluid)
- Wear protection capability
- Aging resistance
- Corrosion protection
- Filterability
- Air separation ability
- Demulsifying ability and water solubility
- Material compatibility

Different operating, environmental, and safety factors require different hydraulic fluids; this is why a broad range of fluids with various chemical composition and viscosity grades are available today. The hydraulic fluids can be classified according to ISO 6743-4 standard as follows:

- Mineral (petroleum) Hydraulic Fluids (HH, HL, HM, HR, HV, HG, HS)
- Biodegradable Hydraulic Fluids (HETG, HEES, HEPG, HEPR)
- Fire-Resistant Hydraulic Fluids (HFA, HFB, HFC, HFD-R, HFD-U)

Incompatibility between the seal material and hydraulic fluid will impact the seal performance and expected seal service life. Absorption and chemical reaction of the fluid with seal material can cause:

- Softening of the seal material (loss of physical strength)
- Hardening of the seal material (loss of flexibility, elasticity)
- Changes in seal materials volume (swelling or shrinking)
- Degradation of the material

The chemical reaction between the fluid and seal material can be accelerated by elevated temperature, resulting in faster changes in physical properties and degradation of the seal material. Table 1 shows the compatibility rating of the most commonly used Chesterton seal materials with the most important fluids groups and materials that are utilized in hydraulic systems.

All data, specifications and technical recommendations in this catalog are for standard mineral hydraulic fluids. For biodegradable and fire-resistant fluid seal applications please contact A.W. Chesterton Company EPS Engineering for guidance and recommendations.

TABLE 1 – CHEMICAL COMPATIBILITY CHART*

Materials	AWC800, AWC805, AWC825 (EU)		AWC860 (EU)		AWC808 (AU)		NBR		FPM		POM	PA	PTFE	PEEK™
	≤60°C (140°F)	≤85°C (185°F)	≤60°C (140°F)	≤120°C (248°F)	≤60°C (140°F)	≤85°C (185°F)	≤60°C (140°F)	≤100°C (212°F)	≤60°C (140°F)	≤100°C (212°F)	≤90°C (194°F)	≤100°C (212°F)	≤100°C (212°F)	≤100°C (212°F)
Mineral oils (ISO 6743-4 classification)														
HH, HL, HM, HR, HV, HG, HS	1	1	1	1	1	1	1	1	1	1	1	1	1	1
Biodegradable hydraulic fluids (ISO 6743-4 classification)														
HETG (Triglycerides)	1	1	1	1	1	1	2	2	1	1	1	1	1	1
HEES (Synthetic ester base)	1	1	1	1	1	1	2	2	1	1	1	1	1	1
HEPG (Polyalkyleneglycol base)	4	4	4	4	1	3	1	2	2	4	1	1	1	1
HEPR (Other base liquid – primarily polyalphaolefins)	4	4	4	4	1	1	2	2	1	1	1	1	1	1
Fire-resistant hydraulic fluids, water-based fluids (ISO 6743-4 classification)														
Water	1	1	1	1	1	1	1	1	1	1	1	3	1	1
HFA (oil in water emulsion (usually >80% water content))	1	1	1	1	1	1	1	1	1	2	1	3	1	1
HFB (water in oil emulsion (usually >40% water content))	1	1	1	1	1	1	1	1	1	1	1	3	1	1
HFC (Glycol solutions, polyalkylene glycol solutions or water glycols (usually >35% water content))	4	4	4	4	2	3	1	1	2	3	1	3	1	1
Fire-resistant hydraulic fluids, water-free fluids (ISO 6743-4 classification)														
HFD-R (Synthetic phosphate esters)	4	4	4	4	4	4	4	4	3	3	4	1	1	1
HFD-U (Synthetic anhydrous liquids other than phosphate ester)	4	4	4	4	1	1	2	3	1	1	1	1	1	1
Mineral greases														
Mineral greases	1	1	1	1	1	1	1	1	1	1	1	1	1	1

Compatibility Rating:

- 1 **Excellent**—No chemical effect
- 2 **Good**—Minor chemical effect
- 3 **Fair**—Moderate effect
- 4 **Not Recommended**—Severe effect

**Actual testing should be conducted to determine the suitability of the material in the fluid and application. Results may vary significantly due to other operating conditions, including but not limited to temperature, concentration, mixtures, etc.*

Seal Materials

Fluid power transmission systems, just like hydraulics and pneumatics are utilized in a wide variety of applications and operating and environmental conditions today. Seals have significant influence on functionality, reliability, effectiveness and environmentally friendly operation of those systems. Meanwhile, the seal performance is partly determined by the seal material.

The proper selection of the seal material will help to achieve the reasonable, expected service intervals and service life. There is a large choice of materials to use in solving the different sealing problems presented by technical, reliability, and environmental concerns.

There are four major groups of synthetic polymers available and utilized in broad range of industrial applications:

- **Polyurethanes:** just like thermoplastic (AU) and thermoset (EU) polyurethanes (Table 1 shows a list of common polyurethanes)
- **Elastomers (rubbers):** just like nitrile rubber (NBR), hydrogenated nitrile rubber (H-NBR), ethylene propylene diene monomer rubber (EPDM), fluorocarbon rubbers (FPM), Vinyl Methyl Silicon Rubber (MVQ), tetrafluoroethylene (TFE) (Table 2 shows a list of common elastomers)
- **Fluoroplastics:** PTFE and its different compounds (such as bronze-filled, glass, Ekonol[®]*, carbon/graphite) (Table 3 shows a list of common PTFE compounds)
- **Engineered Hard Plastics:** rigid thermoplastics and thermosets and their different composites (Table 4 shows a list of common engineered hard plastics)

Seal material properties provide and maintain the sealing function of the seal components during the service life. The most important material properties that must be considered during the selection process are the following:

- Proper durometer (hardness) and flexibility for tight sealing (sealability) and to avoid leaks
- Proper temperature resistance through a broad temperature range
- Good chemical resistance against utilized medias in order to maintain physical properties of the seal material and seal components, further to let material to be used in wide diversity of hydraulic fluids and medias
- Excellent gap extrusion resistance to withstand elevated system pressure and shear stress caused by fluid pressure
- Maintain the elasticity over a broad operating temperature range
- Maintain the elasticity over the expected service life, having resistance against compression set and good stress relaxation behavior
- Mating surface roughness will create wear on the seal's contact area, which should be reduced as much as possible using wear-resistant material in order to avoid early wear out
- Improved tribological properties by low frictional values
- Proper durometer (hardness) and flexibility for easy installation

(Table 5 summarizes the typical physical properties of the most common seal materials. The data and information are intended as only a guide to be used).

*Ekonol[®] is a registered trademark of Saint-Gobain Ceramics & Plastics, Inc.

TABLE 1 – POLYURETHANES

Polyurethanes					
Material code	Description	Color	Durometer Shore A (Shore D)	Material characteristics	Typical uses
AWC800	Thermoset polyether urethane (EU)	Dark maroon	95	High durometer, high performance polyurethane. Excellent wear and tear resistance with low compression set. Excellent extrusion resistance at high pressure. Superior performance in heavy-duty hydraulic and pneumatic and slow rotary applications.	Wiper seals, rod and piston seals, buffer seals, anti-extrusion rings for O-Rings, static seals, rotary seals
AWC805	Thermoset polyether urethane (EU)	Light blue	85	Low durometer, high performance polyurethane. Good wear and tear resistance and low compression set. Performs well in scored or worn equipment, heavy-duty hydraulic cylinders, and presses.	Rod and piston seals including stacked sets and U-Cups
AWC808	Thermoplastic polyester urethane (AU)	Mocha	95	High durometer thermoplastic polyurethane for light- and medium-duty hydraulic and pneumatic applications. Good wear and extrusion resistance.	Wiper seals, rod and piston seals, buffer seals, anti-extrusion rings for O-Rings, static seals, rotary seals
AWC825	Thermoset polyether urethane (EU)	Dark blue	85	Low durometer, high performance machinable polyurethane. Good wear and tear resistance and low compression set. Performs well in scored or worn equipment, heavy-duty hydraulic cylinders, and presses.	Rod and piston seals including stacked sets and U-Cups, static seals
AWC830	Thermoset polyether urethane (EU) FDA	Off white	94	For use in food and pharmaceutical applications where FDA-listed material is required.	Wiper seals, rod and piston seals, buffer seals, anti-extrusion rings for O-Rings, static seals
AWC841	Thermoplastic polyester urethane (C-HPU)	Black	(72)	Extreme high durometer polyurethane for heavy-duty applications. Resistant to water and hot water too.	Rod and piston seals, anti-extrusion rings for dynamic and static applications, support rings, gland adapters for stacked sets
AWC842	Thermoplastic polyester urethane (LT-PU)	Blue	94	Low-temperature thermoplastic polyurethane. Good water and ozone resistance.	Wiper seals, rod and piston seals, buffer seals, anti-extrusion rings for O-Rings, static seals
AWC860	Thermoset polyether urethane (EU) high temp	Bright red	95	Higher temperature use. Excellent wear and tear resistance with low compression set. Compatible with most hydraulic fluids except synthetics. Superior performance in hydraulic and pneumatic and slow rotary applications. Excellent extrusion resistance at high pressure.	Wiper seals, rod and piston seals, buffer seals, anti-extrusion rings for O-Rings, static seals, rotary seals

TABLE 2 – ELASTOMERS

Elastomer					
Material code	Description	Color	Durometer Shore A	Material characteristics	Typical uses
AWC742	NBR	Black	85	Good general purpose elastomer material. Compatible in hydrocarbon-based fluids, alkalis, and acids. Low permanent set and good elasticity. Oil-resistant cost competitive material.	Rod and piston seals, static seal, energizers
AWC743	H-NBR	Green	85	H-NBR has improved abrasion resistance while still retaining high elasticity. Its service temperature range is from -20°C – 150°C. It also works for a short time in hot air up to 180°C.	Rod and piston seals including stacked sets and U-Cups
AWC744	H-NBR	Black	90	This material is similar to our standard H-NBR but with a hardness of 90 shore and having increased pressure and extrusion resistance.	Rod and piston seals, static seals, energizers
AWC752	EPDM	Black	85	The material has very good low-temperature properties, high resistance to ozone, aging, and weathering as well as polar solvents (alcohols, ketones, esters) and HFC liquids and glycol-based brake fluids.	Rod and piston seals, static seals, energizers
AWC754	EPDM FDA	White	82	EPDM FDA white is FDA-CFR21.177.2600 compliant.	Rod and piston seals, static seals, energizers
AWC701	FPM	Brown	82	Good heat resistance and compatibility with aggressive fluid such as phosphate esters, synthetic hydraulic fluids, many chemicals, and organic solvents. Very good ozone, weather, and aging resistance. Moderate wear and tear resistance.	Wiper seals, rod and piston seals, static seals
AWC702	FPM FDA	Brown	80	It is FDA - CFR 21.177.2600 compliant and also meets 3A Sanitary standard 18-03, thus it is suitable for the food and beverage industry.	Wiper seals, rod and piston seals, static seals
AWC703	FPM	Black	85	This material has similar characteristics to AWC701. It is approved to NORSOK M-710 standard, for applications with rapid gas decompression.	Wiper seals, rod and piston seals, static seals
AWC727	TFE/ AFLAS®	Black	85	Superior heat resistance. Compatible with steam/hot water with a recommended operating range of -10°C – 170°C (14°F – 338°F). Best compatibility with phosphate esters, amines, engine oils, pulp and paper liquors, and high concentrations of acid/alkali/oxidant.	Wiper seals, rod and piston seals, static seals
AWC766	MVQ Silicon	Blue	85	MVQ (silicone) has a high resistance to low and high temperatures (-60°C up to 220°C and short time up to 300°C). Concerning the chemical composition, silicone is often used in the food industry.	Rod and piston seals, static seals, energizers
AWC768	MVQ Silicon FDA	White	85	This material is similar to AWC766, but in nature color with hardness 85 A and FDA-CFR21.177.2600 compliance.	Rod and piston seals, static seals, energizers

*Aflas® is a registered trademark of Asahi Glass Co., Ltd.

TABLE 3 – FLUOROPLASTICS

Fluoroplastics					
Material code	Description	Color	Durometer Shore D	Material characteristics	Typical uses
AWC300	PTFE Glass + MoS ₂ -filled	Dark grey	56	High-wear, high-pressure and high-speed applications. High PV values with excellent fluid compatibility. Excellent in high viscosity fluids.	Slide rings of rod and piston seals, slide rings of WCCS wiper seals, anti-extrusion rings for static seals, wear rings, stacked sets and spring energized seals, rotary seals
AWC400	PTFE Carbon/graphite-filled	Black	62	Water and steam applications. High PV values. Excellent all-purpose material for rotary applications. Good electrical conductivity.	Slide rings of rod and piston seals, slide rings of WCCS wiper seals, anti-extrusion rings for static seals, wear rings, stacked sets and spring energized seals, rotary seals
AWC500	PTFE Bronze-filled	Bronze	67	Good bearing and extrusion properties. Bronze provides higher thermal conductivity, allowing higher running velocities. Chemical resistance is somewhat lowered because bronze is attacked by some acids and alkalis. Best used in high-pressure hydraulic applications.	Slide rings of rod and piston seals, slide rings of WCCS wiper seals, anti-extrusion rings for static seals, wear rings, stacked sets and spring energized seals, rotary seals
AWC510	PTFE Mineral filled-FDA	White	66	FDA listed material with better wear resistance than unfilled PTFE. Excellent where cleaner environments are required.	Slide rings of rod and piston seals, slide rings of WCCS wiper seals, anti-extrusion rings for static seals, wear rings, stacked sets and spring energized seals, rotary seals
AWC520	PTFE unfilled	White	62	Static or slow-speed applications with low wear resistance. Works well in vacuum and low gas permeability applications. Superior fluid compatibility.	Anti-extrusion rings for static seals, wear rings, stacked sets and spring energized seals, rotary seals
AWC530	PTFE Ekonol® filled	Cream	58	Good wear- and heat-resistant properties. High vacuum service in dynamic conditions for moderate speed and higher pressure applications. High-temperature non-aqueous applications.	Anti-extrusion rings for static seals, wear rings, stacked sets and spring energized seals, rotary seals

TABLE 4 – ENGINEERED HARD PLASTICS

Engineered Hard Plastics					
Material code	Description	Color	Durometer Shore D	Material characteristics	Typical uses
AWC610	UHMWPE unfilled (FDA)	White translucent	61	Highly abrasion resistant in reciprocating or slow rotary applications. Excellent in water-based fluids. Economical and excellent in cryogenic applications.	Stacked sets, spring energized seals
AWC625	UHMWPE glass-filled	White	69	Abrasive, high-wear, reciprocating, or slow rotary applications. Excellent in water-based fluids but chemical compatibility and upper temperatures are limited.	Stacked sets, spring energized seals
AWC650	POM Polyacetal	Black	85	Excellent creep resistance under continuous load, fatigue and endurance under repeated cycles.	Anti-extrusion rings for dynamic and static applications, wear rings guiding components in light and medium duty applications, gland adapters for V-Ring sets
AWC663	PA6 Nylon	Off white	83	Good general purpose polyamide material. Bearing material. Compressive strength 90–100 MPa (13,050–14,500 psi).	Anti-extrusion rings for dynamic and static applications, wear rings and guiding components in light- and medium-duty applications, gland adapters for stacked sets, gland adapters for V-Ring sets
AWC665	PA6 Nylon MoS ₂ -filled	Black	85	Better wear properties with MoS ₂ than unfilled material. Bearing material. Compressive strength 100–110 MPa (14,500–15,950 psi).	Anti-extrusion rings for dynamic and static applications, wear rings and guiding components in medium- and heavy-duty applications, gland adapters for V-Ring sets
AWC630	PEEK unfilled	Tan	86	Better wear characteristics. Tough, reliable, and dimensionally stable, even under continuous elevated temperatures. Excellent wear characteristics for seals and wear rings.	Anti-extrusion rings for dynamic and static applications, wear rings and guiding components in heavy-duty applications, spring energized seals
AWC635	PEEK glass-filled	Cream	88	Designed for improving the wear rate of unfilled PEEK (AWC630) in high performance applications. Tough, reliable, and dimensionally stable, even under continuous elevated temperatures. Good backup ring material in backup ring applications.	Anti-extrusion rings for dynamic and static applications, wear rings and guiding components in heavy-duty applications, spring energized seals

Table 5. summarizes the typical physical properties of the most common seal materials. The data and information are intended as only a guide to be used.

Ekonol® is a registered trademark of Saint-Gobain Ceramics & Plastics, Inc.

TABLE 5 – MATERIAL DATA

POLYURETHANES																			
Properties	Standard	Unit		AWC800 (EU)		AWC805 (EU)		AWC808 (AU)		AWC825 (EU)		AWC830 FDA (EU)		AWC841 (C-HPU)		AWC842 (LT-PU)		AWC860 High Temp (EU)	
		Metric	English	Metric	English	Metric	English	Metric	English	Metric	English	Metric	English	Metric	English	Metric	English	Metric	English
Standard color				Dark Maroon		Light Blue		Mocha		Dark Blue		White		Black		Blue		Bright Red	
Durometer Shore A	ISO 868	Shore A	Shore A	95 ± 2	85 ± 2	95 ± 2	85 ± 2	95 ± 2	85 ± 2	94 ± 2	94 ± 2	94 ± 2	96 ± 2	96 ± 2	96 ± 2	96 ± 2	96 ± 2	95 ± 2	95 ± 2
Durometer Shore D	ISO 868	Shore D	Shore D	46 ± 2	33 ± 2	46 ± 2	33 ± 2	46 ± 2	33 ± 2	45 ± 2	45 ± 2	45 ± 2	-	-	-	-	-	46 ± 2	46 ± 2
Specific gravity/density	DIN EN ISO 1183	kg/m ₃	g/cm ₃	1140	1080	1200	1080	1200	1120	1200	1200	1200	1200	1210	1210	1210	1210	1100	1100
Modulus @ 100%	DIN 53504	MPa	psi	≥ 17	≥ 6.45	≥ 15	≥ 9.95	≥ 15	≥ 21.75	≥ 14.2	≥ 14.2	≥ 14.2	≥ 14.2	≥ 30	≥ 43.50	≥ 30	≥ 17.40	≥ 15	≥ 21.75
Modulus @ 300%	DIN 53504	MPa	psi	≥ 38	≥ 24.7	≥ 28	≥ 35.80	≥ 28	≥ 41.60	-	-	-	-	-	-	-	≥ 22	≥ 24	≥ 34.85
Tensile strength	DIN 53504	MPa	psi	≥ 48	≥ 26.5	≥ 50	≥ 38.35	≥ 50	≥ 72.50	≥ 20	≥ 20	≥ 20	≥ 20	≥ 50	≥ 72.50	≥ 50	≥ 45	≥ 59	≥ 85.55
Elongation at break	DIN 53504	%	%	≥ 420	≥ 320	≥ 350	≥ 320	≥ 350	≥ 350	≥ 230	≥ 230	≥ 230	≥ 230	≥ 150	≥ 150	≥ 150	≥ 450	≥ 540	≥ 540
Tear strength	DIN ISO 34-1	kN/m	lbf/inch	≥ 110	-	≥ 110	-	≥ 110	≥ 570	≥ 11	≥ 62	≥ 760	≥ 133	≥ 110	≥ 625	≥ 80	≥ 450	≥ 140	≥ 800
Abrasion	DIN 53516	mm ₃	mm ₃	22	-	17	-	17	17	-	-	-	-	-	-	≥ 20	≥ 20	-	-
Compression set 70°C/24h 25% compression	ISO 815	%	%	≤ 22	≤ 19	≤ 27	≤ 19	≤ 27	≤ 27	≤ 21	≤ 21	-	-	-	-	≥ 25	≥ 25	≤ 22	≤ 22
Compression set 100°C/24h 25% compression	ISO 815	%	%	-	-	≤ 33	-	≤ 33	≤ 33	-	-	-	-	-	-	-	-	-	-
Minimum service temperature	-	°C	°F	-50	-40	-20	-40	-20	-4	-40	-40	-35	-31	-	-	-55	-67	-50	-58
Maximum service temperature	-	°C	°F	85	185	85	185	85	185	85	185	167	75	-	-	110	230	120	248

ELASTOMERS																			
Properties	Standard	Unit		Values		Values		Values		Values									
		Metric	English	Metric	English	Metric	English	Metric	English	Metric	English								
Standard color		Black		Green		Black		White		Brown		Black		Black		Blue		White	
Durometer Shore A	ISO 868	Shore A	Shore A	85 ± 5	85 ± 5	85 ± 5	85 ± 5	85 ± 5	85 ± 5	85 ± 5	85 ± 5	85 ± 5	85 ± 5	85 ± 5	85 ± 5	85 ± 5	85 ± 5	85 ± 5	85 ± 5
Durometer Shore D	ISO 868	Shore D	Shore D	-	-	-	-	-	-	-	-	-	-	-	-	-	-	-	-
Specific gravity/Density	DIN EN ISO 1183	kg/m ³	g/cm ³	1.28	1.32	1.28	1.32	1.22	1.22	2.53	2.40	2.40	2.53	1.87	1.87	1.73	1.73	1.55	1.47
Modulus @ 100%	DIN 53504	MPa	psi	≥ 11	≥ 1595	≥ 11	≥ 1595	≥ 4	≥ 580	≥ 6	≥ 6	≥ 6	≥ 870	≥ 7	≥ 1015	≥ 4	≥ 580	≥ 4	≥ 725
Modulus @ 300%	DIN 53504	MPa	psi	-	-	-	-	-	-	-	-	-	-	-	-	-	-	-	-
Tensile strength	DIN 53504	MPa	psi	≥ 17	≥ 2465	≥ 12	≥ 1740	≥ 7	≥ 1015	≥ 9	≥ 8	≥ 1160	≥ 9	≥ 1305	≥ 6	≥ 870	≥ 7	≥ 1015	≥ 1015
Elongation at break	DIN 53504	%	%	≥ 150	≥ 150	≥ 80	≥ 80	≥ 160	≥ 160	≥ 200	≥ 150	≥ 200	≥ 140	≥ 140	≥ 200	≥ 200	≥ 120	≥ 100	≥ 100
Tear strength	DIN ISO 34-1	KN/m	lbf/inch	≥ 18	≥ 102	10	55	-	-	20	114	-	≥ 7	≥ 39	≥ 6	≥ 35	≥ 15	≥ 85	≥ 90
Abrasion	DIN 53516	mm ³	mm ³	100	100	140	140	291	291	175	200	200	-	-	230	230	-	-	-
Compression set 70°C/24h 25% compression	ISO 815	%	%	≤ 5	≤ 5	≤ 7	≤ 7	≤ 25	≤ 25	≤ 17	≤ 9	≤ 13	≤ 13	≤ 13	≤ 40	≤ 40	≤ 8	≤ 10	≤ 10
Compression set 100°C/24h 25% compression	ISO 815	%	%	≤ 6	≤ 6	-	-	-	-	-	-	-	-	-	-	-	-	-	-
Maximum service temperature	-	°C	°F	-30	-22	-45	-49	-45	-49	-4	-20	-4	-20	-4	-5	23	-60	-76	-76
Minimum service temperature	-	°C	°F	110	230	130	266	130	266	220	428	210	410	200	392	200	392	200	392

TABLE 5 CONTINUED – MATERIAL DATA

TABLE 5 CONTINUED – MATERIAL DATA

FLOUROPLASTICS																	
Properties	Standard	Unit		Values		Values		Values		Values							
		Metric	English	Metric	English	Metric	English	Metric	English	Metric	English						
		Standard color		Dark Yellow		Grey		Black		Bronze		White		White		Cream	
Durometer Shore A	ISO 868	Shore A	Shore A	-	-	-	-	-	-	-	-	-	-	-	-	-	-
Durometer Shore D	ISO 868	Shore D	Shore D	57	56	56	62	62	62	67	67	66	66	62	62	58	58
Specific gravity/Density	DIN EN ISO 1183	kg/m ³	g/cm ³	1820	2230	2.23	2.13	2.13	3.13	3.13	2.26	2.26	2.18	2.18	2.07	2.07	2.07
Modulus @ 100%	DIN 53504	MPa	psi	-	-	-	-	-	-	-	-	-	-	-	-	-	-
Modulus @ 300%	DIN 53504	MPa	psi	-	-	-	-	-	-	-	-	-	-	-	-	-	-
Tensile strength	DIN 53504	MPa	psi	≥ 17.3	≥ 2500	≥ 2650	≥ 17.3	≥ 2500	≥ 22.8	≥ 3307	≥ 19.3	≥ 2800	≥ 24.2	≥ 3500	≥ 19.33	≥ 2800	≥ 2800
Elongation at break	DIN 53504	%	%	≥ 200	≥ 200	≥ 265	≥ 200	≥ 200	≥ 250	≥ 250	≥ 250	≥ 250	≥ 300	≥ 300	≥ 250	≥ 250	≥ 250
Tear strength	DIN ISO 34-1	kN/m	lbf/inch	-	-	-	-	-	-	-	-	-	-	-	-	-	-
Abrasion	DIN 53516	mm ³	mm ³	-	-	-	-	-	-	-	-	-	-	-	-	-	-
Compression set 70°C/24h 25% compression	ISO 815	%	%	-	-	-	-	-	-	-	-	-	-	-	-	-	-
Compression set 100°C/24h 25% compression	ISO 815	%	%	-	-	-	-	-	-	-	-	-	-	-	-	-	-
Minimum service temperature	-	°C	°F	-200	-328	-200	-328	-200	-200	-328	-200	-328	-200	-328	-200	-328	-328
Maximum service temperature	-	°C	°F	260	500	260	500	260	260	500	260	500	260	500	260	260	500

TABLE 5 CONTINUED – MATERIAL DATA

ENGINEERED PLASTICS																	
Properties	Standard	Unit		AWC610 UHMWPE		AWC625 UHMWPE glass filled		AWC 650 FDA POM		AWC663 PA6		AWC665 PA6 MoS ₂ filled		AWC630 FDA PEEK		AWC635 PEEK glass filled	
		Metric	English	Metric	English	Metric	English	Metric	English	Metric	English	Metric	English	Metric	English	Metric	English
Standard color		White		White		Black		Black		Black		Black		Tan		Cream	
Durometer Shore A	ISO 868	Shore A	Shore A	-	-	-	-	-	-	-	-	-	-	-	-	-	-
Durometer Shore D	ISO 868	Shore D	Shore D	61	69	69	69	85	85	83	83	85	85	86	86	88	88
Specific gravity/Density	DIN EN ISO 1183	kg/m ₃	g/cm ₃	940	930	0.93	0.93	1410	1410	1150	1150	1150	1150	1300	1300	1510	1510
Modulus @ 100%	DIN 53504	MPa	psi	-	-	-	-	-	-	-	-	-	-	-	-	-	-
Modulus @ 300%	DIN 53504	MPa	psi	-	-	-	-	-	-	-	-	-	-	-	-	-	-
Tensile strength	DIN 53504	MPa	psi	≥ 38	≥ 5600	≥ 40	≥ 5800	≥ 69	≥ 10000	≥ 75	≥ 10500	≥ 85	≥ 12330	≥ 95	≥ 13800	≥ 155.8	≥ 22600
Elongation at break	DIN 53504	%	%	≥ 350	≥ 350	≥ 250	≥ 250	≥ 30	≥ 30	≥ 25	≥ 25	≥ 20	≥ 20	≥ 45	≥ 45	≥ 27	≥ 27
Tear strength	DIN ISO 34-1	kN/m	lbf/inch	-	-	-	-	-	-	-	-	-	-	-	-	-	-
Abrasion	DIN 53516	mm ₃	mm ₃	-	-	-	-	-	-	-	-	-	-	-	-	-	-
Compression set 70°C/24h 25% compression	ISO 815	%	%	-	-	-	-	-	-	-	-	-	-	-	-	-	-
Compression set 100°C/24h 25% compression	ISO 815	%	%	-	-	-	-	-	-	-	-	-	-	-	-	-	-
Minimum service temperature	-	°C	°F	-200	-328	-200	-328	-40	-40	-40	-40	-40	-40	-50	-58	-50	-58
Maximum service temperature	-	°C	°F	260	180	260	180	90	194	110	230	110	230	250	482	250	482

Storage and Shelf Life of Seal Components

Seals and wear rings made of elastomers, polyurethanes, fluoroplastics, and engineered plastics are frequently on the shelf as stored spare parts for a long time. The seal material physical properties can change during storage as a result of either chemical reaction or physical process. Such changes in material properties can lead to degradation of seal conditions and they can become unserviceable. Typical aging phenomena are hardening, cracking, softening, crazing, and other deterioration of the seal surfaces.

The changes might be the result of different physical and/or chemical factors including heat, humidity, light, oxygen, ozone, and exposure by other chemicals in the surroundings of the seals such as oils, solvents, and other industrial chemicals, or external physical impact that can result in permanent deformation of the seal components.

Yet elastomers, polymers, and several of the engineered plastics can maintain their original physical properties for a limited time without significant changes if they are stored and kept on shelf properly.

Basic information and instruction on storage, cleaning, and maintenance of elastomer, rubber seal components are provided by international standards, such as ISO 2230 and DIN7716. Elastomer products should be stored according to recommendations in order to maintain the original, optimum physical property values of the materials for the entire recommended shelf life.

Heat: The ideal storage temperature is between 5°C and 25°C (41°F and 77°F). Direct contact with any source of heat should be avoided (radiator, boiler or any heater, direct sunlight). If the storage temperature is below 15°C (60°F), care should be taken during handling in order to avoid any distortion or exceeded deformation because they might have stiffened. In this case the seal component(s) should be slowly warmed up to 20°C (68°F) or to ambient temperature.

Humidity: The relative humidity in the storeroom should be less than 70%. Extreme moist or dry conditions should be avoided and condensation should not occur.

Light: Elastomer seals should be protected from any light sources, especially direct sunlight or strong artificial light with ultraviolet radiation. Individual storage bags offer good protection if they are made of UV-resistant polyethylene.

Oxygen and ozone: Elastomer materials should be protected from circulating air. Ozone deteriorates many elastomers, so storerooms should not contain any equipment that is capable of generating ozone, such as high voltage electric equipment, electric motor, or mercury vapor lamps.

Deformation: Elastomers and seals should be stored in a relaxed condition. Compression, tension, or any other type of deformation should be avoided. As the delivered articles are packed in stress-free condition, they should be stored in their original packaging.

Contact with metals: Direct contact with certain metals should be avoided, as they have degrading effect on rubbers (iron, copper and its alloys, etc.)

Contact with non-metals: Direct physical contact between rubber products or rubber and plastic products should be avoided because of possible transfer of plasticizer or other ingredients.

Shelf life

When elastomer seals are stored in the recommended conditions described above, seal components retain their typical properties. Recommended shelf life by material grade can be found in the chart below:

Material Grade	Shelf Life
EU Thermoset polymers (AWC800, 805, 825, 830, 860)	25 years
AU Thermoplastic polymers (AWC808)	10 years
NBR (AWC740, 741, 742, 743, 744, 745)	6 years
Neoprene with cotton (AWC735)	1 year
Butyl with cotton (AWC747)	1 year
FKM (AWC701, 702, 703, 704, 715, 716, 730, 733)	10 years
PTFE (AWC100, 200, 300, 400, 500, 510, 520)	unlimited
PEEK™ (AWC630, 635)	unlimited
UHMWPE (AWC610, 615, 620)	20 years
Polyester resin (AWC640)	5 years
Polyacetal POM (AWC650)	5 years
Polyamide PA (AWC665)	5 years





ISO Reference List

International Standard	Description	Chesterton Product Group Codes
ISO 5597:2018	Hydraulic fluid power—Cylinders—Dimensions and tolerances of housings for single-acting piston and rod seals in reciprocating applications—Dimensions and tolerances	R22K, R22KAER, R22KAER1, P22K, P22KAER, P22KAER1, R22KE, R22KEAER, R22KEAER1, P22KE, P22KEAER, P22KAER1 R22KN, R22KN1, R22KN5, P22KN, P22KN1, P22KN5,
ISO 6195A:2013	Fluid power systems and components—Cylinder-rod wiper-ring housings in reciprocating applications—Dimensions and tolerances—Wiper Type A	W21K, W21KF, W21KR, W21KT5, W21KH
ISO 6195B:2013	Fluid power systems and components—Cylinder-rod wiper-ring housings in reciprocating applications—Dimensions and tolerances—Wiper Type B	CW21K, CW21K1, CW21K2, CW21K3
ISO 6195C:2013	Fluid power systems and components—Cylinder-rod wiper-ring housings in reciprocating applications—Dimensions and tolerances—Wiper Type C	W21KC, W21KCS, W11-E, W12-E
ISO 6195D:2013	Fluid power systems and components—Cylinder-rod wiper-ring housings in reciprocating applications—Dimensions and tolerances—Wiper Type D	WCCS
ISO 6195E:2013	Fluid power systems and components—Cylinder-rod wiper-ring housings in reciprocating applications—Dimensions and tolerances—Wiper Type E	W21KS
ISO 6547:1981	Hydraulic fluid power—Cylinders—Piston seal housings incorporating bearing rings—Dimensions and tolerances	P20K4, P20K2P4, P20K5, P20K6
ISO 7425-1:1988	Hydraulic fluid power—Housings for elastomer-energized, plastic-faced seals—Dimensions and tolerances—Part 1: Piston seal housings	PCCS, PCCS1, PCCS2, PCCS3, PCCS4
ISO 7425-2:1989	Hydraulic fluid power—Housings for elastomer-energized, plastic-faced seals—Dimensions and tolerances—Part 2: Rod seal housings	RCCS, RCCS1, RCCS2, RCCS3, RCCS4
ISO10766:2014	Hydraulic fluid power—Cylinders—Housing dimensions for rectangular-section-cut bearing rings for pistons and rods	16K, 19K, WR
ISO 3601-2:2016	Fluid power systems—O-Rings—Part 2: Housing dimensions for general applications	OR, OR1, R20KDR, P20KDR, 20KDRFS
ISO 6194-1:2007	Rotary shaft lip-type seals incorporating elastomeric sealing elements—Part 1: Nominal dimensions and tolerances	30K, 30KW, 30KSW, 30KB, 30KWB, 30KP, 33K
ISO 16589-1:2011	Rotary shaft lip-type seals incorporating thermoplastic sealing elements—Part 1: Nominal dimensions and tolerances	30K, 30KW, 30KSW, 30KB, 30KWB, 30KP, 33K
ISO 3069:2000	End-suction centrifugal pumps—Dimensions of cavities for mechanical seals and for soft packing	30KC, 14K, 14KLR

Other Relevant International Standards	
ISO 2230:2002	Rubber products—Guidelines for storage
ISO 4287:1997	Geometrical Product Specifications (GPS)—Surface texture: Profile method—Terms, definitions and surface texture parameters
ISO 4288:1996	Geometrical Product Specifications (GPS)—Surface texture: Profile method—Rules and procedures for the assessment of surface texture
ISO 6194-2:2009	Rotary shaft lip-type seals incorporating elastomeric sealing elements—Part 2: Vocabulary
ISO 6194-3:2009	Rotary shaft lip-type seals incorporating elastomeric sealing elements—Part 3: Storage, handling and installation
ISO 6194-4:2009	Rotary shaft lip-type seals incorporating elastomeric sealing elements—Part 4: Performance test procedures
ISO 12922:2012	Lubricants, industrial oils and related products (class L)—Family H (Hydraulic systems)—Specifications for hydraulic fluids in categories HFAE, HFAS, HFB, HFC, HFDR and HFDU
ISO 6743-4:2015	Lubricants, industrial oils and related products (class L)—Classification—Part 4: Family H (Hydraulic systems)
ISO 6072:2011	Rubber—Compatibility between hydraulic fluids and standard elastomeric materials
ISO 7986:1997	Hydraulic fluid power—Sealing devices—Standard test methods to assess the performance of seals used in oil hydraulic reciprocating applications

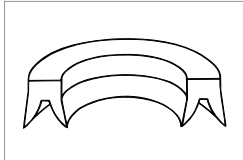
Troubleshooting Guide

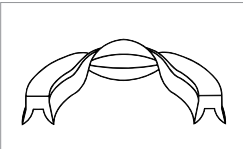
This section provides troubleshooting criteria for Chesterton's hydraulic and pneumatic sealing devices. It should be used only as a general reference guide when repacking, rebuilding, or redesigning any cylinder or press. Specific guidance can be provided by your Chesterton representative. By installing superior, longer lasting seals and components in a properly designed cylinder, one can expect greatly extended service life.

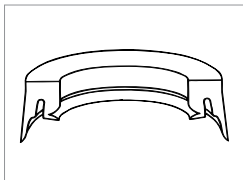
SEAL CONDITION		No visible damage, but leaking	
		Probable Cause	Possible Solution
 	Incorrect size seal not sealing dynamically or statically.	Check seal and equipment dimensions. Check for additional causes of leak such as static O-Ring or gasket leak.	
	Hydroplaning due to low sealing pressure with high viscosity fluid and too smooth surface finish.	Check fluid pressure on return to tank cycle. Check dynamic surface finish. Check cycle speed. Consider alternate seal design with higher preload.	
SEAL CONDITION		Rolled or twisted seal may have permanent creases from twisting in seal cavity and may be severely rolled	
		Probable Cause	Possible Solution
 	A variety of conditions may cause rolling of a seal. Drag due to sizing problem, vacuuming, extrusion, or swelling may all cause seals to roll. In addition, side loading and shock loading could be contributing factors.	Check dimensions of seal and equipment. Check system and application for operating conditions. Look for other types of damage to help troubleshoot this problem.	
SEAL CONDITION		Seal lips are crushed, crimped or creased	
		Probable Cause	Possible Solution
 	Seal is too tall for groove.	Remachine seal groove or choose a shorter seal.	
	Loose bottom bushing under the seal hits the seal when pressurized.	Secure and vent the bottom bushing.	
	Seal is being mechanically loaded by a metallic or elastomeric retaining device.	Remove the device if not necessary or rework device to prevent contact with seal lip(s).	
	Seal is being dragged to bottom of groove or box by vacuum or by improper sizing of the seal.	Correct the vacuum condition or secure the seal with a retaining device. Check the seal dimensions and correct application of piston and rod designed seals.	
	Piston cup lip is jammed by the hold down plate on the piston or is acting as a stop at the end or stroke.	Correct inside ("d ₂ " dimension) of the piston cup relative to the diameter of the hold down plate. Provide mechanical stop on the stroke or choose a cup with a shorter lip.	

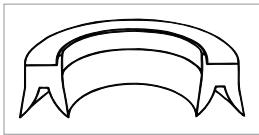
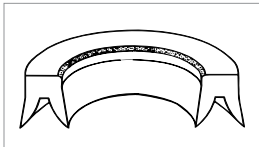
SEAL CONDITION		Extrusion of inside diameter heel	
		Probable Cause	Possible Solution
		If extrusion is evident all around the circumference of the inside diameter heel, rod or ram to gland or bushing clearance is excessive for pressure.	Rework or replace the gland or bushing to achieve recommended clearance. Use a rigid backup ring.
		If extrusion is evident on half of the circumference of the inside diameter heel, rod or ram is side loading. The gland may not be centered or the cylinder head may be cocked.	Rework or replace the gland or bushing. Replace bearings. Use a backup ring. Check the gland for centering.

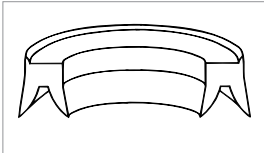
SEAL CONDITION		Extrusion of outside diameter heel	
		Probable Cause	Possible Solution
 <p>A. Piston Application</p>		A1: If extrusion is evident all around the circumference of the outside diameter heel, the piston head-to-bore clearance is excessive. This may be due to the design, wear, or pressure swelling or "ballooning."	A1: Rework or replace the piston head or retube to achieve the recommended clearance. Use non-metallic bearing band(s) to prevent wear. Check the cylinder integrity relative to maximum pressure. Use backup rings under extreme shock loads.
			A2: If extrusion is evident on half of the circumference of the outside diameter heel, the piston is side loading or the cylinder is out-of-round.

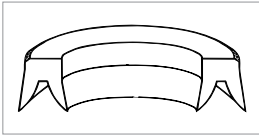
 <p>B. Rod Seal Application</p>		B: Excessive clearance between the gland and stuffing box bore.	B: Rework or replace the gland or use a backup ring.
--	---	---	--

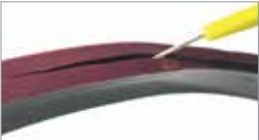
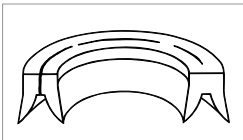
SEAL CONDITION		U-Cup split through the center of its cross section	
		Probable Cause	Possible Solution
		If splitting or separation is apparent over most or all of the seal's circumference, the cause is a radial oversizing or incorrect seal size.	Check the equipment dimensions and compare them to the seal dimensions.

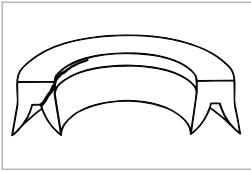
SEAL CONDITION		U-Cup or piston cup lip is separated from heel	
		Probable Cause	Possible Solution
		If splitting or separation is apparent over a small portion of the seal's circumference, the cause is a lack of concentricity or ovality of the equipment.	Rework or replace the bearing support to achieve concentricity of the rod and piston. Check the stuffing box and cylinder bores for roundness.

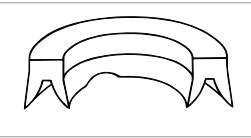
SEAL CONDITION		Crescent shaped section missing from dynamic sealing lip	
		Probable Cause	Possible Solution
		Piston seal lip is passing over the port either during installation or actual use.	Chamfer the sharp internal port edges, and alter the stroke or piston design to avoid the port. If damage was caused during installation, use a shim or otherwise protect the seal from sharp edges.

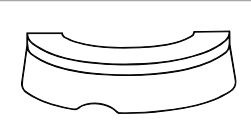
		Seal lip was kinked, jammed, or curled back during installation.	Use care when installing. Don't use sharp tools. Check the lip before pushing it into the bore.
---	---	--	---

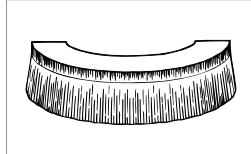
SEAL CONDITION		Excessive abrasion or grooving of dynamic sealing lip	
		Probable Cause	Possible Solution
		A1: Excessive wear on the outside diameter indicates an issue with the cylinder bore finish.	A1: Rework or replace the cylinder tube to a bore finish of 8-24 R.M.S (Ra).

A. Piston Application

A2: Excessive wear on the outside diameter indicates abrasive particles in the system.	A2: Check the condition of the fluid. Filter the system with a portable filtration or drain and flush system.
--	---

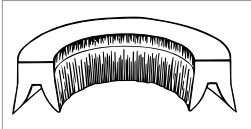

		B1: Excessive wear on the inside diameter indicates a poor rod finish.	B1: Rework or replace the rod or ram to achieve a finish of 8-24 R.M.S (Ra).
---	---	--	--

B. Rod Seal Application

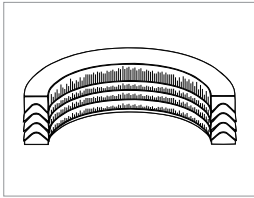

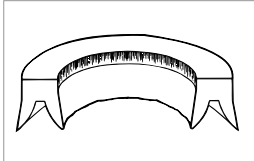
B2: Excessive wear on the inside diameter indicates abrasive particles in the system.	B2: Install a sharp lip, abrasion-resistant wiper. Consider an externally mounted, easily replaceable wiper. It may require a custom wiper in excessively wet/dirty environments.
---	---

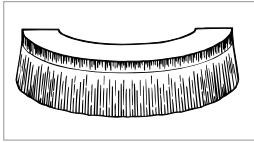
SEAL CONDITION		Excessive wear, misshaping, darkening of V-Ring sets in stacked sets	
		Probable Cause	Possible Solution
 	Undercompression of the stacked V-Ring set can cause rings to roll or twist and bind causing leakage and excessive friction.	<p>Check split, if applicable; check alignment of each ring before installing next ring.</p> <hr/> <p>Measure equipment and seal set carefully; shim and adjust properly. If ram or rod is binding, loosening of the load on the set may ease binding. May need to remove and repack V-Rings properly.</p>	
	Overcompression of the stacked V-Ring set can cause binding and excessive friction due to lack of lubricating barrier and additional drag.		

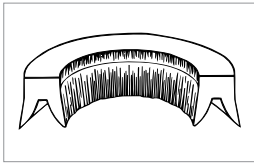
SEAL CONDITION		Wear on dynamic heel 360° of seal's circumference	
		Probable Cause	Possible Solution
 	Misapplication of rod or piston designed seal or wrong seal size.	Use rod seals for rod applications and piston mounted seals on pistons. Check equipment and seal dimensions.	

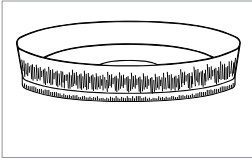
SEAL CONDITION		Excessive wear on dynamic heel and lip of 180° of seal's circumference. May also show extrusion of dynamic heel 180° opposite of the worn side of the seal	
		Probable Cause	Possible Solution
  <p>A. Piston Application</p>	<p>A. Excessive side load or side load due to misalignment, mounting and clevis design or application and design causing bushing and wear ring wear and excessive seal wear.</p> <p>B. Bushing and wear ring wear increase clearances resulting in possible extrusion.</p>	<p>Rework or replace bearing or bushing to achieve concentricity. Check for misalignment or the cause of side loading. Increase bearing area with strong, non-metallic bearings. Check diametrical clearances for adequate seal support.</p>	
  <p>B. Rod Seal Application</p>			

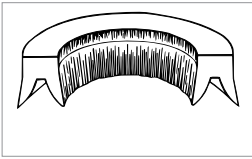
SEAL CONDITION		Excessive wear on heel 360° of circumference of piston cup, often the seal lip will not show wear	
		Probable Cause	Possible Solution
		Overcompression of the piston cup due to overtightening of the hold-down plate or the base thickness is too great for the available space which causes the heel to squeeze out.	Compress the flange thickness (H ₂)10%. Check the base thickness relative to space available. Do not overtighten. Check the cup visually after tightening for heel squeeze-out.

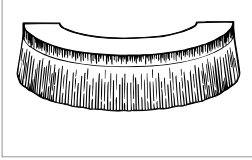
SEAL CONDITION		Vertical/axial scratches on static lip may be associated with other damage	
		Probable Cause	Possible Solution
		Incorrect sizing of the rod or piston seal will cause the seal to move axially in the seal groove/stuffing box. Axial movement is evident due to scratches on the static lip.	Check the dimensions of the seal groove/stuffing box and rod or bore diameter. Check for seal fit and correct application of the rod seal or piston mounted seal.
A. Piston Application		Vacuuming due to the inability of the fluid to fill the cylinder to make up for increasing volumetric area.	Correct shock loading if possible. Check the system for pipe flow volume. Consider an alternate seal design.
		A: Excessive wear or "pock-marked" appearance on the <i>outside</i> diameter indicates a poor static finish on the box bore or seal groove.	A: Rework to achieve a static finish of 32–45 R.M.S. (Ra).
B. Rod Seal Application		B: Excessive wear or "pock-marked" appearance on the <i>inside</i> diameter indicates a poor static finish on the piston seal groove.	B: Rework to achieve a static finish of 32–45 R.M.S. (Ra).

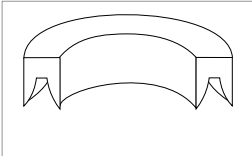
SEAL CONDITION		Discoloration, swelling, softening, or hardening of seal compound	
		Probable Cause	Possible Solution
		Fluid incompatibility with the hydraulic fluid, lubricating oil, installation grease, or cleaning solvent.	Check the compatibility of the seal compound. Change the fluid type or substitute a seal compound.

SEAL CONDITION	Black, tar-like deposits and/or burned spots, possibly burned completely through the heel of the seal. This damage will appear in the crotch area between the seal lips.	
----------------	--	--

	Probable Cause	Possible Solution
--	----------------	-------------------

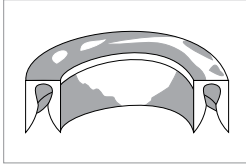

Dieseling due to auto ignition of the hydraulic fluid causing intense heat at the damaged area. Dieseling results from trapped air bubbles in the fluid rising to settle between the seal lips where, under pressure, the bubbles are compressed. Rapid decompression of the compressed air bubbles results in energy released as heat.

Bleed all air from the hydraulic system. Caution should be used to bleed the system after any work is done to the pump, valves, lines, or actuators.

SEAL CONDITION	Seal is dark or black in color, has lost flair, or is drastically misshaped	
----------------	---	--

	Probable Cause	Possible Solution
--	----------------	-------------------

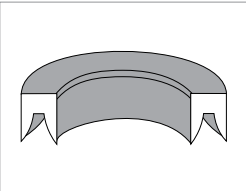

Darkening of the entire seal indicates excessive fluid temperatures or environmental heat exposure.

Protect against the environmental heat source. Maintain or utilize the cooling system. Use high temperature seal compound.

Darkening of the dynamic lip only indicates excessive friction due to speed, lack of lubricity, or jamming of the dynamic lip or heel.

Check the reciprocating or rotating speed. Check lubrication of the pneumatic system or lubricity of the hydraulic fluid. Look for evidence of jamming of the lip or extrusion of the heel.

A drastically misshaped seal indicates prolonged exposure to heat or extremely high heat. This may be caused by the continual rolling of the seal in the groove.

Use a high-temperature seal compound. Check the seal groove dimensions.

Engineering Action Request Form

CONTACT INFORMATION

Name _____ Date _____
 Company _____ Address _____
 Telephone _____ e-mail _____
 Customer _____

New Tooling Only (Fill out profile and material below)

Seal Profile or Description _____ Material _____

OPERATING CONDITIONS

static reciprocating rotary oscillating

Pressure: psi <input type="checkbox"/> bar <input type="checkbox"/> Operating _____ Min _____ Max _____ Direction: <input type="checkbox"/> Unidirectional pressure <input type="checkbox"/> Bidirectional pressure Vacuum: Yes <input type="checkbox"/> No <input type="checkbox"/>	Speed: ft/min <input type="checkbox"/> m/s <input type="checkbox"/> Stroke length _____ Cycles/min _____ RPM _____	Temperature: C <input type="checkbox"/> F <input type="checkbox"/> Continuous _____ Min _____ Max _____	Media _____ Gas <input type="checkbox"/> Liquid <input type="checkbox"/> Name _____
---	---	--	---

Describe existing seal problem or expectation: _____

Describe existing seal design and material: _____

EQUIPMENT

Application _____ Surface finish _____ R.M.S. Ra
 Manufacturer _____ Hardness _____ Rc
 Model _____ Plating/Coating _____
 Misalignment _____ mm _____ in Eccentricity (T.I.R.) _____ mm _____ in
 (shaft to bore) or Run-out

See reverse side for equipment dimensioning.

Describe application and/or operating conditions: _____

Equipment Dimensioning

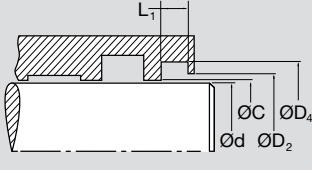
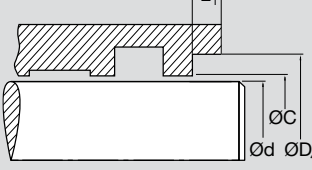
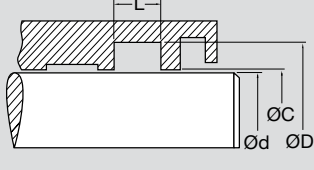
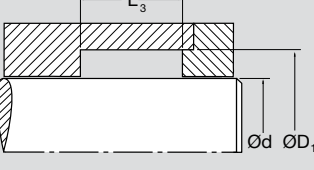
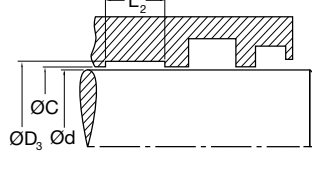
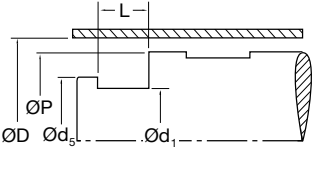
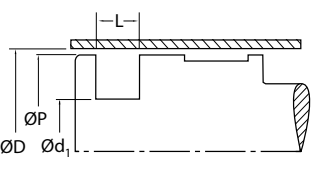
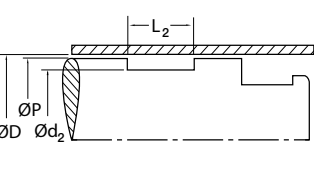
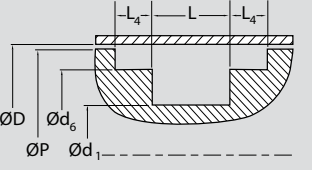
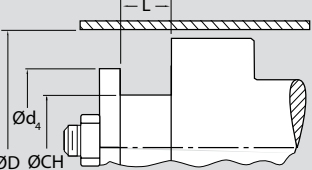
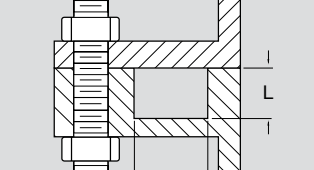
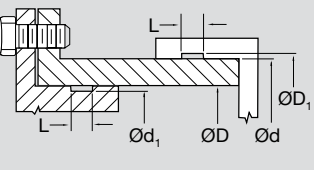
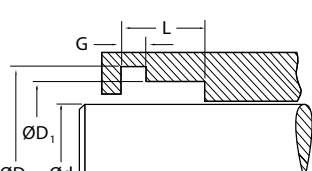
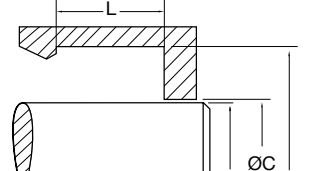
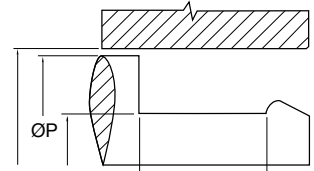
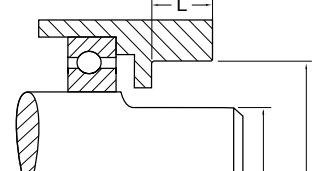
<p>Rod Wiper</p>  <p> Ød: _____ $\text{ØD}_4:$ _____ ØC: _____ $L_1:$ _____ $\text{ØD}_2:$ _____ </p>	<p>Canned Rod Wiper</p>  <p> Ød: _____ $\text{ØD}_4:$ _____ ØC: _____ $L_1:$ _____ </p>	<p>Rod Seal</p>  <p> Ød: _____ $\text{ØD}_1:$ _____ ØC: _____ $L:$ _____ </p>	<p>Rod Packing</p>  <p> Ød: _____ $L_3:$ _____ $\text{ØD}_1:$ _____ </p>
<p>Rod Wear Ring</p>  <p> Ød: _____ $\text{ØD}_3:$ _____ ØC: _____ $L_2:$ _____ </p>	<p>Piston Seal U-Cup</p>  <p> $\text{Ød}_1:$ _____ ØP _____ $\text{Ød}_5:$ _____ $L:$ _____ ØD: _____ </p>	<p>Piston Bidirectional Seal</p>  <p> $\text{Ød}_1:$ _____ ØP: _____ ØD: _____ $L:$ _____ </p>	<p>Piston Wear Ring</p>  <p> ØD: _____ ØP: _____ $\text{Ød}_2:$ _____ $L_2:$ _____ </p>
<p>Bidirectional Piston Seal</p>  <p> $\text{Ød}_1:$ _____ ØP: _____ ØD: _____ $L:$ _____ $\text{Ød}_6:$ _____ $L_4:$ _____ </p>	<p>Piston Cup Seal</p>  <p> ØD: _____ ØCH: _____ $\text{Ød}_4:$ _____ $L:$ _____ </p>	<p>Face Seal</p>  <p> $\text{I.D.:$ _____ $L:$ _____ $\text{O.D.:$ _____ </p>	<p>O-Ring Gland</p>  <p> Piston Mount ØD: _____ $\text{ØD}_1:$ _____ Rod Mount $\text{Ød}_1:$ _____ Ød: _____ $L:$ _____ $L:$ _____ </p>
<p>Flanged Shaft Seal Gland</p>  <p> $\text{ØD}_1:$ _____ $G:$ _____ Ød: _____ $L:$ _____ $\text{ØD}_2:$ _____ </p>	<p>Rod Seal Rotary</p>  <p> $\text{ØD}_1:$ _____ ØC: _____ Ød: _____ $L:$ _____ </p>	<p>Piston Seal Rotary</p>  <p> ØD: _____ ØP: _____ $\text{Ød}_1:$ _____ $L:$ _____ </p>	<p>Rotary Shaft Seal</p>  <p> ØD: _____ $L:$ _____ Ød: _____ </p>

EPS Industrial Cylinder Survey for Reciprocating Applications

Customer: _____
 Contact Name: _____
 Phone/Fax/Email: _____

Project/Job/Reference #/Kit Name: _____
 Ø Rod: _____ Ø Bore: _____
 Request Date: _____

Application Details

Pressure: _____
 Speed: _____

Temperature: _____
 System Fluid: _____

WIPER

Ød: _____
 ØD₄: _____
 L₁: _____
 X: _____

Snap-In Wiper

W21K W21KF W21KS W21KR
 W21KSR W21K5 W21KC

Canned Wiper

ØD₄
 Ød

CW21K CW21K1
 CW21K2 CW21K3

Available Materials: _____ Material: _____
 Profile: _____ Can Material (AWC650 POM): _____

ROD SEAL

ØD₁
 Ød

U-Cups

R22KE R22K R22KAER R22KN5 R22KN R23K

Ød: _____ Profile: _____
 ØD₁: _____ Material: _____
 L: _____ 9K AER: _____

20Ks

R20K R20K3

Material: _____
 Split: Yes No
 Quantity: _____

Cap Seals

RCCS RCCS2 RCCS3 RCCS4

Available Materials: U-Cup/20K: AWC800, 808, 825, 830, 860, 704, 742; Cap Seal: 400, 500, 800, 860;
 Loaders: O-Ring, AWC730, 740, 715; Rectangular: AWC704, 742

ROD PACKING

ØD₁
 Ød

Ød: _____
 ØD₁: _____
 X: _____
 Y: _____
 L₃ (Y-X): _____

Stacked Sets

27K, 8K 11K 600

Profile: _____
 Material: _____
 9K AER: _____
 Material: _____
 Split: Yes No
 Quantity: _____

Available Materials: 27K/8K/11K: AWC800, 805, 808, 825, 830, 860, 704, 742; 600: AWC735, 747

ROD WEAR RING

ØD₃
 Ød

Ød: _____
 ØD₃: _____
 L₂: _____
 Quantity: _____
 Material: _____
 Profile: _____

Coil 16K & 17K
Available Materials: AWC640

WR 18K, 19K
Available Materials: AWC650, 660, 665

U-CUP PISTON SEAL

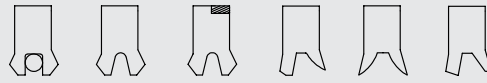
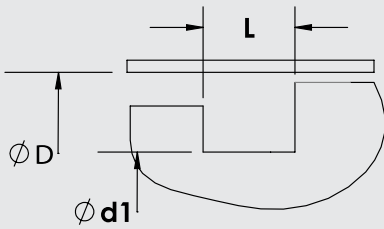

P22KE P22K P22KAER P22KN5 P22KN P23K
Partial AER

Full Radial AER:
Yes No
Split: Yes No

Ød₁: _____ Profile: _____
ØD: _____ Material: _____
L: _____

Available Materials: AWC800, 825, 830, 860, 704, 742

BI-DIRECTIONAL PISTON SEAL

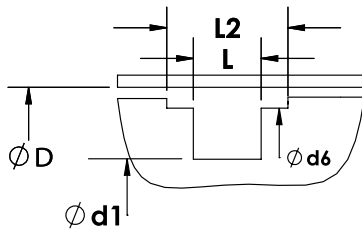

Ød₁: _____
ØD: _____
L: _____
L₂: _____
Ød₆: _____

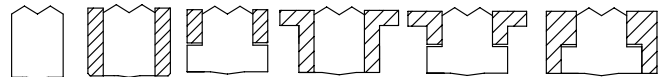

P20K1 P20K2 P20K3 P20K4 P20K5 P20K6

20KHD available in all profiles

Profile: _____
Material: _____

Cap Seals

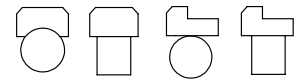

PCCS PCCS2 PCCS3 PCCS4

Available Materials: 20K: AWC800, 808, 825, 830, 860, 704, 742; Cap Seal: 400, 500, 800, 860;
Loaders: O-Ring, AWC730, 740, 715, 727; Rectangular: AWC704, 742

PISTON WEAR RING

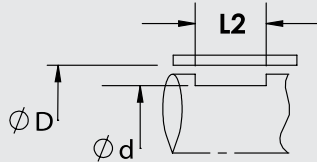

Ød₂: _____
ØD: _____
L: _____
L₂: _____
Quantity: _____
Material: _____

Profiles:

Coil 16K & 17K

Available Materials: AWC640

WR 18K, 19K

Available Materials: AWC650, 660, 665

STATIC SEAL

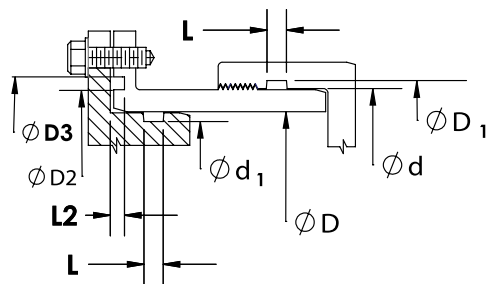

Piston Mount

ØD: _____
Ød₁: _____
L: _____

Rod Mount

ØD₁: _____
Ød: _____
L: _____

Face Seal

ØD₂: _____
ØD₃: _____
L₂: _____

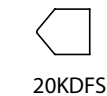

Backup Ring:

Yes No
Split: Yes No

Quantity: _____

Material: _____

Material: _____

Available Materials: 20KD Rings: AWC800, 808, 825, 830, 860, 704, 742; O-Rings: AWC730, 740, 715, 727

Product Index

PRODUCT	TYPE	PAGE
100 Series	Cantilever Spring Design	78, 105
14K	Restriction Bushings	76, 104
14KL	Lantern Rings	77, 104
16K and 17K	Hydraulic Wear Ring Strips	58, 101
18K and 19K	Wear Rings	54, 101
200 Series	Elliptical Coil Spring Design	80, 105
20KD	Face and Static Seals	50, 97
300 Series	Helical Wound Spring Design	82, 105
30K	PTFE Lip Seals	62, 102
30KC	Cartridge Multi Lip Seal	75, 104
33K	Split Rotary Seals	61, 102
500 Series	Stacked V-Ring Seals	84, 106
50K	Mill Rotary Face Seals	64, 102
51K	Mill Rotary Seals	66, 103
52K	Mill Rotary Seals	68, 103
53K	Premium Mil Rotary Seals	70, 103
600 Series	Continuous Contact Spring Energized Seals	85, 106
9K	Anti-extrusion Rings	52, 101
CW21K	Canned Wiper Seals	13, 94
Kaplan	Kaplan Turbine Runner Blade Trunnion Split Seal	72, 104
P11K	Piston Seals	44, 99
P20K	Piston Seals	46, 100, 108
P22K	Piston Seals	32, 98, 107
P22KE	Piston Seals	36, 98, 107
P22KN	Piston Seals	34, 98, 107
P23K	Piston Seals	38, 98
P27K	Piston Seals	42, 99
P28K	Piston Seals	39, 99
P7K	Piston Seals	37, 100
P8K	Piston Seals	40, 99
PCCS	Piston Seals	48, 100, 108
PLS	Polymer Labyrinth Seal	74
R11K	Rod Seals	20, 96
R20K	Rod Seals	29, 97
R22K	Rod Seals	16, 95, 107
R22KE	Rod Seals	18, 95, 107
R22KN	Rod Seals	17, 95, 107
R22KN5	Split Rotary Seals	60, 95, 102
R23K	Rod Seals	19, 95
R27K	Rod Seals	26, 96
R28K	Rod Seals	28, 96, 108
R600	Rod Seals	22, 96
R6K	Rod Seals	15, 95
R8K	Rod Seals	24, 96
RCCS	Rod Seals	30, 97, 107
W21K	Wiper Seals	12, 94
WCCS	Wiper Seals	14, 94
WR	Custom Wear Rings	56, 101



Global Solutions, Local Service

Since its founding in 1884, the A.W. Chesterton Company has successfully met the critical needs of its diverse customer base. Today, as always, customers count on Chesterton solutions to increase equipment reliability, optimize energy consumption, and provide local technical support and service wherever they are in the world.

Chesterton's global capabilities include:

- Servicing plants in over 113 countries
- Global manufacturing operations
- More than 500 Service Centers and Sales Offices worldwide
- Over 1200 trained local Service Specialists and Technicians

Visit our website at chesterton.com



Ekonol® is a registered trademark of Saint-Gobain Ceramics and Plastics, Inc.
Aflas® is a registered trademark of Asahi, Glass Co., Ltd.
SpeedSeal™ is a trademark of A.W. Chesterton Company.

Chesterton ISO certificates available on
chesterton.com/corporate/iso

Distributed by:

Technical data reflects results of laboratory tests and is intended to indicate general characteristics only. A.W. Chesterton Company disclaims all warranties express, or implied, including warranties of merchantability and fitness for a particular purpose. Liability, if any, is limited to product replacement only. Any images contained herein are for general illustrative or aesthetic purposes only and are not intended to convey any instructional, safety, handling or usage information or advice respecting any product or equipment. Please refer to relevant Safety Data Sheets, Product Data Sheets, and/or Product Labels for safe use, storage, handling, and disposal of products, or consult with your local Chesterton sales representative.

© 2018 A.W. Chesterton Company.

® Registered trademark owned by A.W. Chesterton Company
in USA and other countries, unless otherwise noted.



A.W. Chesterton Company
860 Salem Street
Groveland, MA 01834 USA

Telephone: 781-438-7000
Fax: 978-469-6528
chesterton.com

Form No. EN75558
Polymer Seals Catalog – English
12/18